

# INSTALLATION GUIDE

Applicable Models: inPulse, inPulse+

---

Version: 1.1

Date: Dec, 2015

Green  
Label

# Safety Precautions

Before installation, please read the following safety precautions for user safety and to prevent product damage.



**Do not** install the device in a place subject to direct sun light, humidity, dust or soot.



**Do not** place a magnet near the product. Magnetic objects such as magnet, CRT, TV, monitor or speaker may damage the device.



**Do not** place the device next to heating equipment.



**Do not** to let liquid like water, drinks or chemicals leak inside the device.



**Do not** let children touch the device without supervision.



**Do not** drop or damage the device.



**Do not** disassemble, repair or alter the device.



**Do not** use the device for any purpose other than those specified.



**Clean** the device often to remove dust on it. In cleaning, do not splash water on the device but wipe it out with smooth cloth or towel.

**Contact** your supplier in case of a problem!

# Device Overview

## ❖ inPulse+

### Front

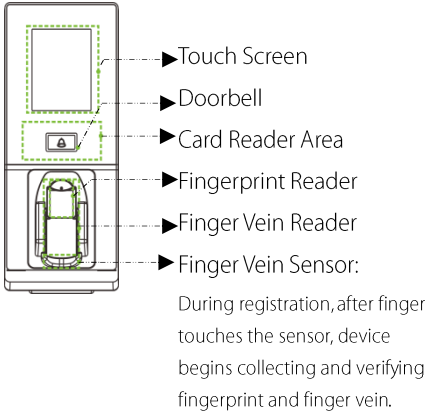

### Left Side

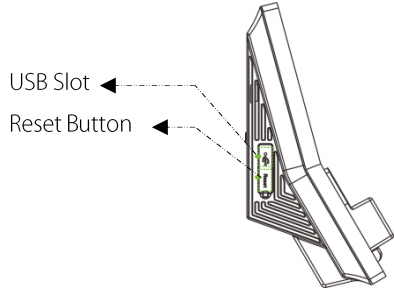

## ❖ inPulse

### Front

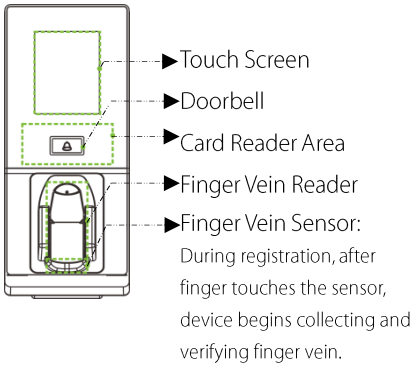

### Left Side

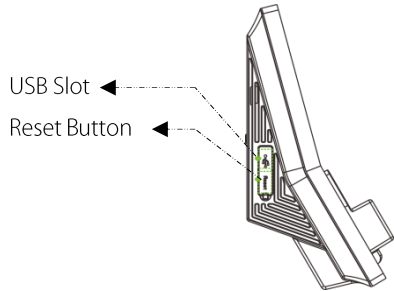

# Device Overview

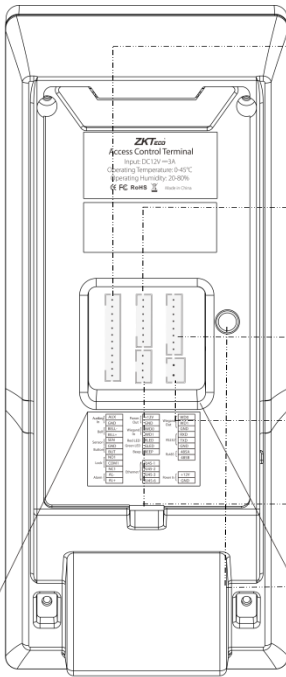

▶ 12 Pin Cable Connectors

▶ 7 Pin Cable Connectors

▶ 8 Pin Cable Connectors

▶ 2 Pin Cable Connectors

▶ 4 Pin Cable Connectors Ethernet (TCP/IP)

▶ Tamper Alarm Button

- Auxiliary In
- Bell
- Sensor
- Button
- Lock
- Alarm
- Power Out
- Wiegand In
- LED, Beep
- Wiegand Out
- RS232
- RS485
- Power In

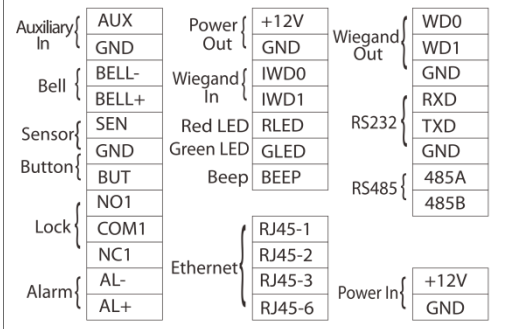

# Product Dimensions & Installation

## ❖ Product Dimensions

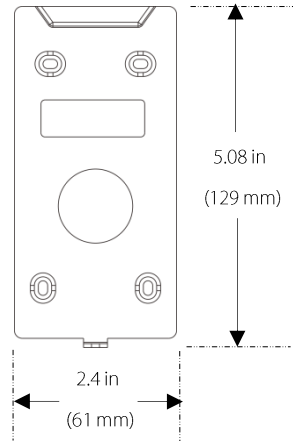
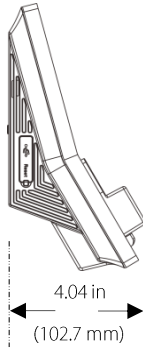
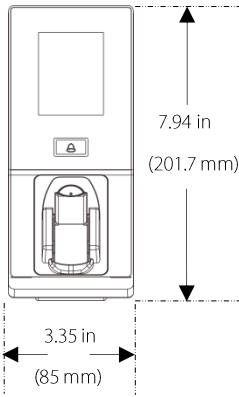

## ❖ Mounting the Device on Wall

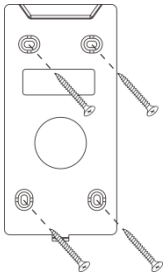

- 1 Fix the back plate onto the wall using wall mounting screws.

**Note:** We recommend drilling the mounting plate screws into solid wood (i.e. stud/beam). If a stud/beam cannot be found, use supplied drywall plastic anchors.

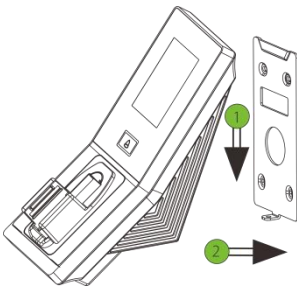

- 2 Insert the device to back plate.

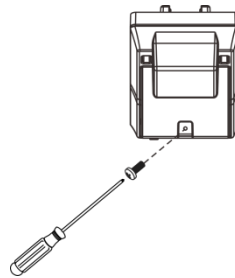

- 3 Use security screws to fasten the device to back plate.

# Power Connection

## ❖ Without UPS

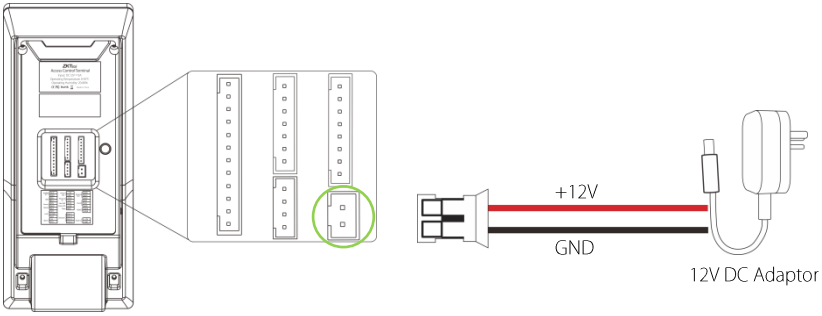

## ❖ With UPS (Optional)

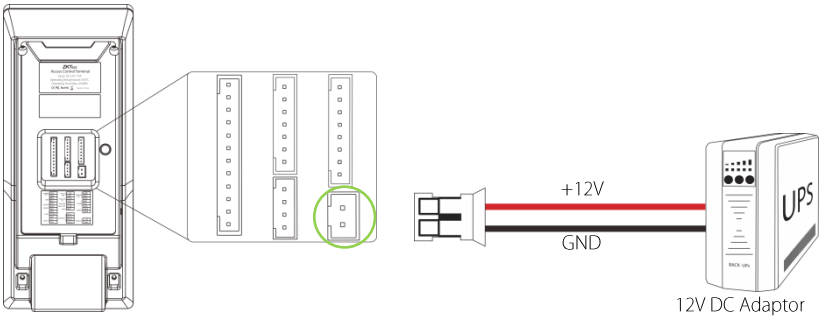

## ❖ Recommended Power Supply

- 12V±10%, at least 500MA.
- To share the power with other devices, use a power supply with higher current ratings.

# Ethernet Connection

## ❖ LAN Connection

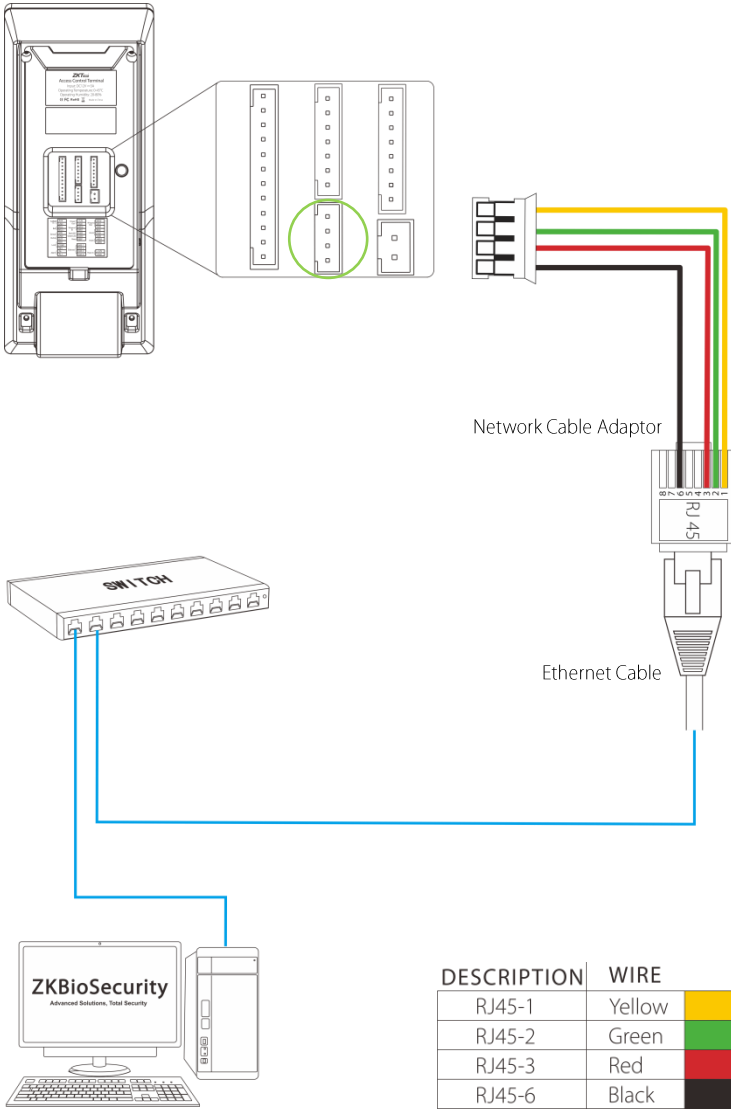

# Ethernet Connection

## ❖ Direct Connection

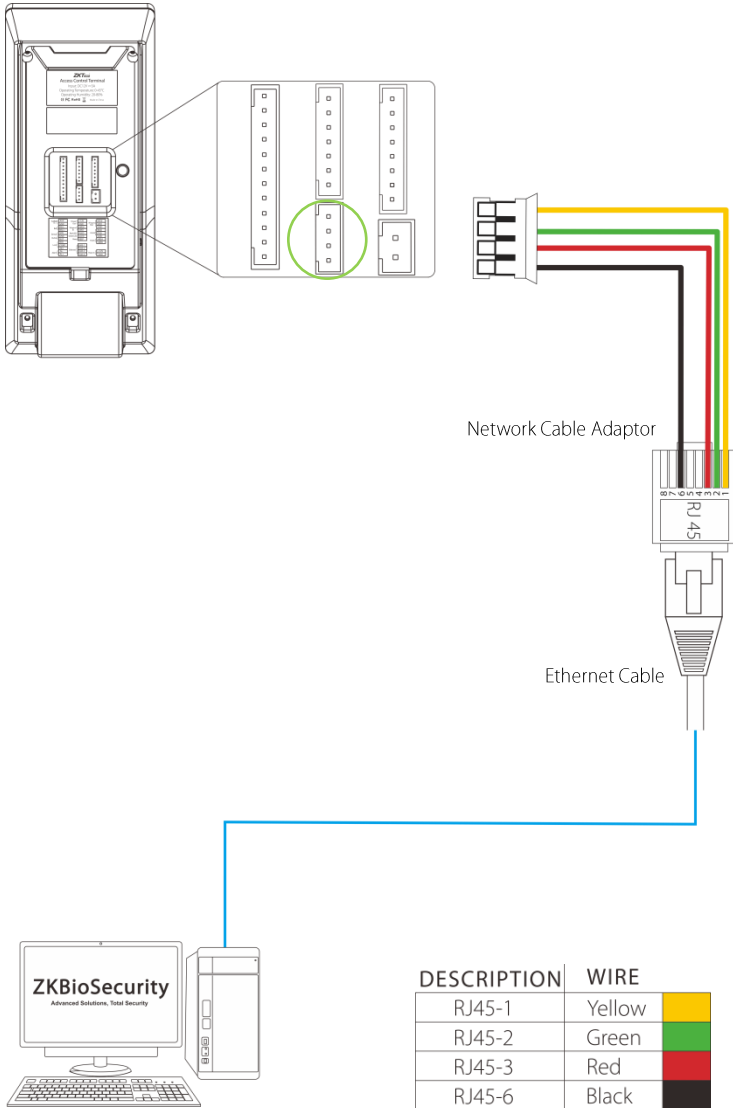



# Lock Relay Connection

## ❖ Device Not Sharing Power with the Lock

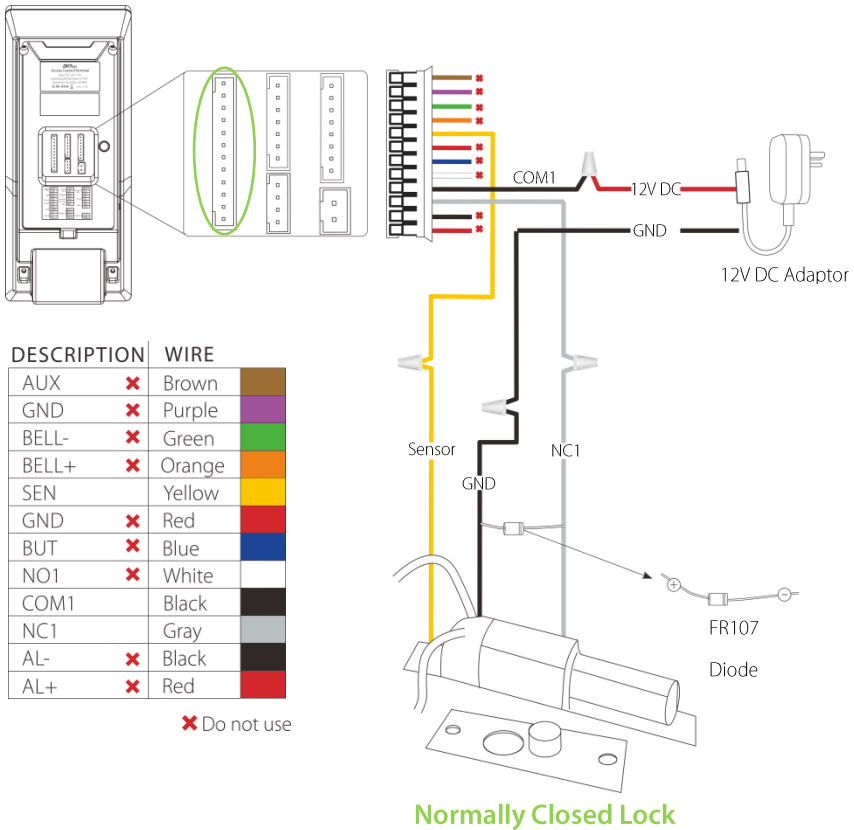

### Notes:

1. The system supports **NO LOCK** and **NC LOCK**. For example the **NO LOCK** (normally opened at power on) is connected with '**NO1**' and '**COM1**' terminals, and the **NC LOCK** (normally closed at power on) is connected with '**NC1**' and '**COM1**' terminals.
2. When electrical lock is connected to the Access Control System, you must parallel one FR107 diode (equipped in the package) to prevent the self-inductance EMF from affecting the system.

 Do not reverse the polarities.

# Lock Relay Connection

## ❖ Device Sharing Power with the Lock

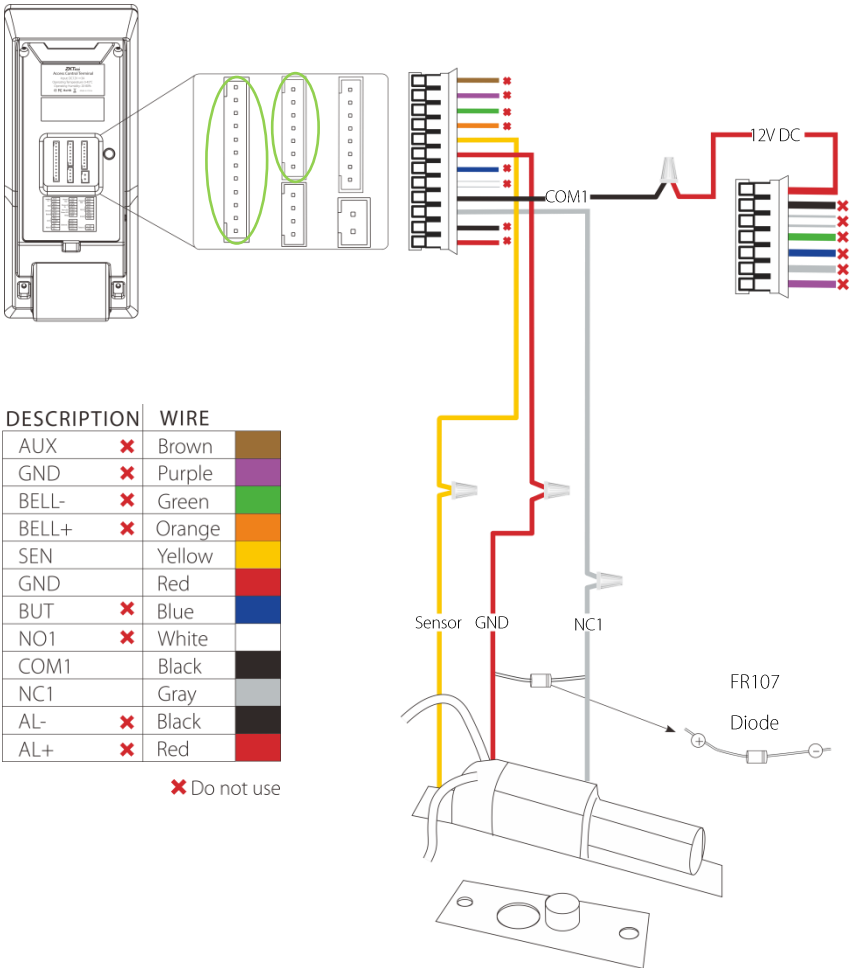

Normally Closed Lock

# Wiegand Output Connection

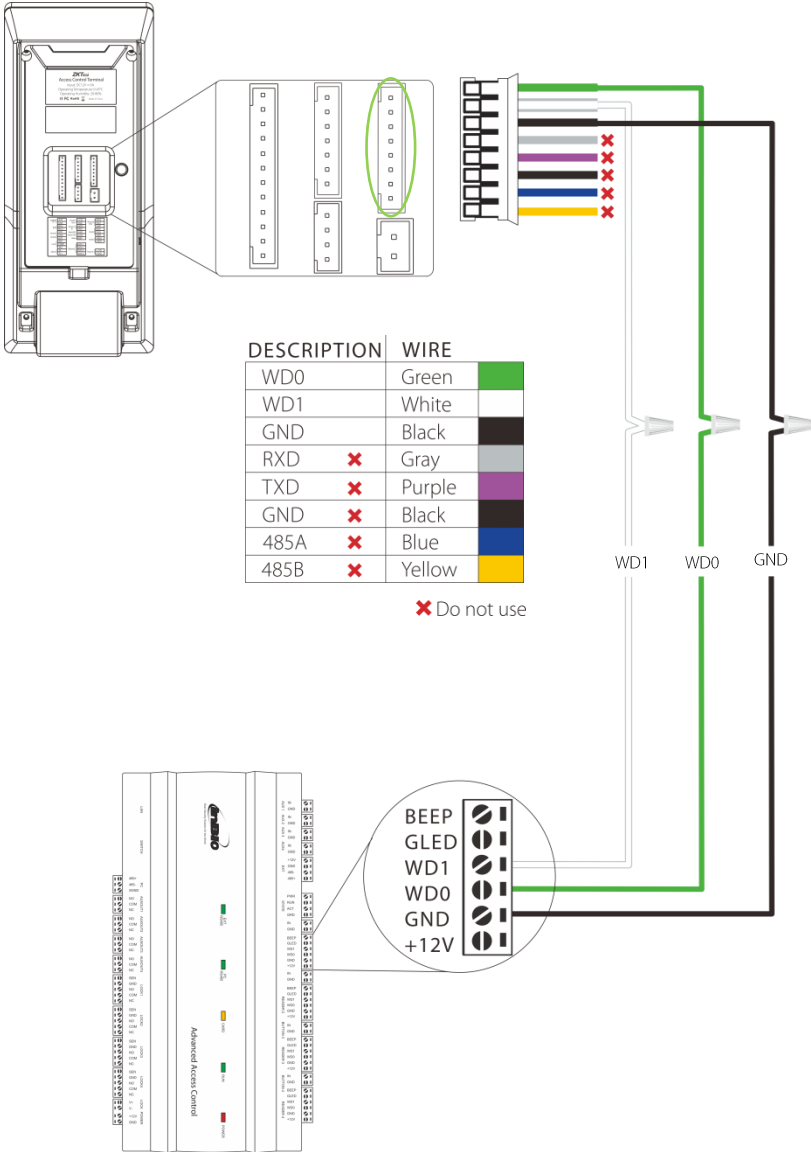

# Standalone Installation

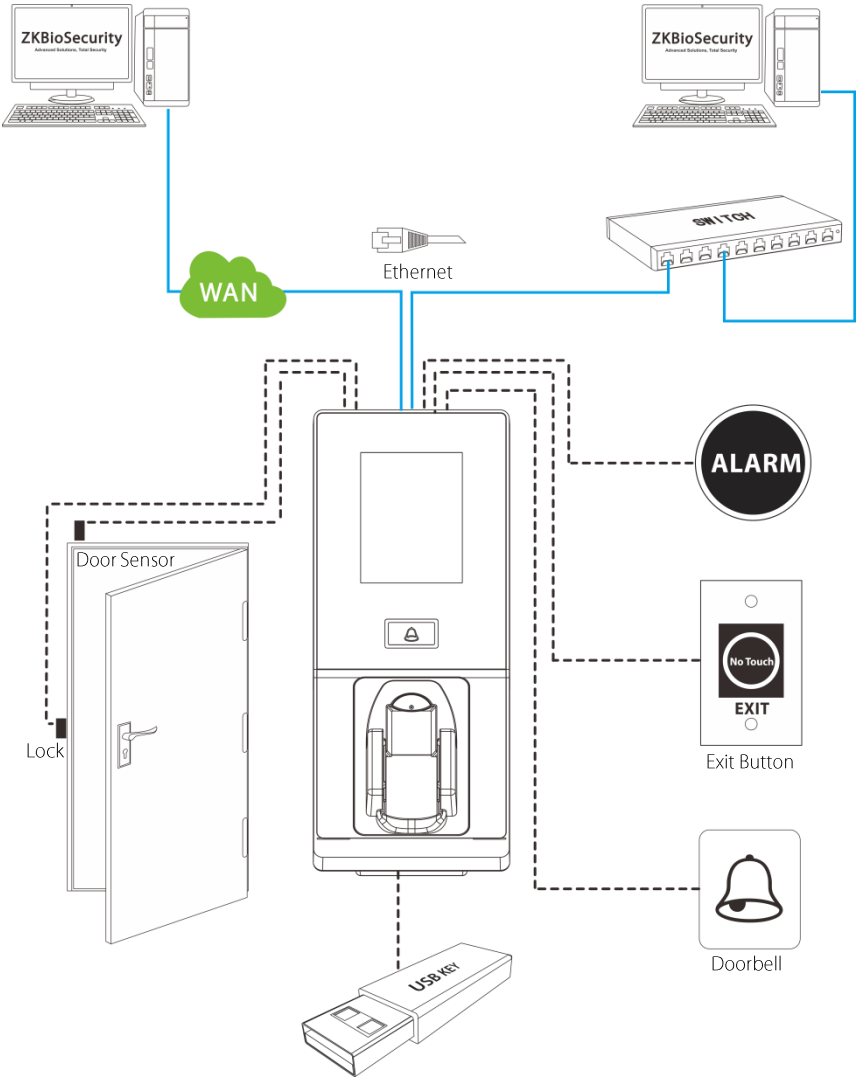

# Third Party Controller

## ❖ Wiegand Output Connection

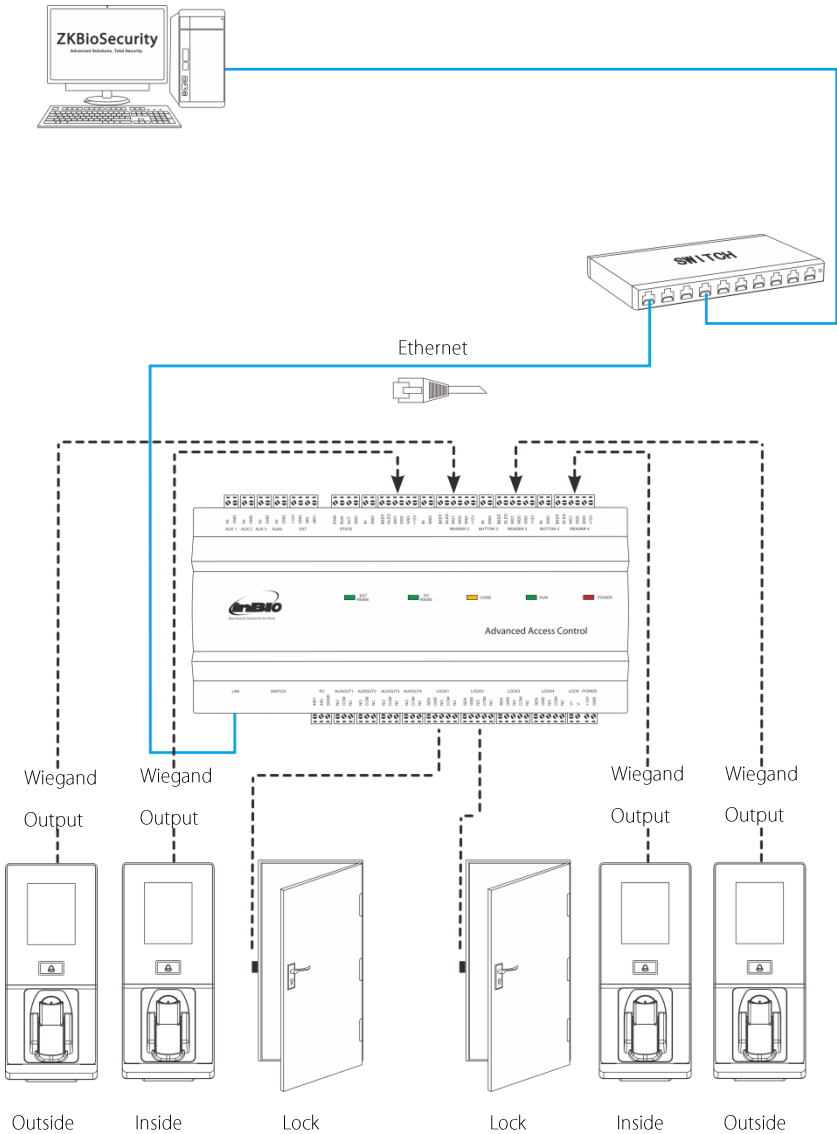

# How Does inPulse / inPulse+ Work

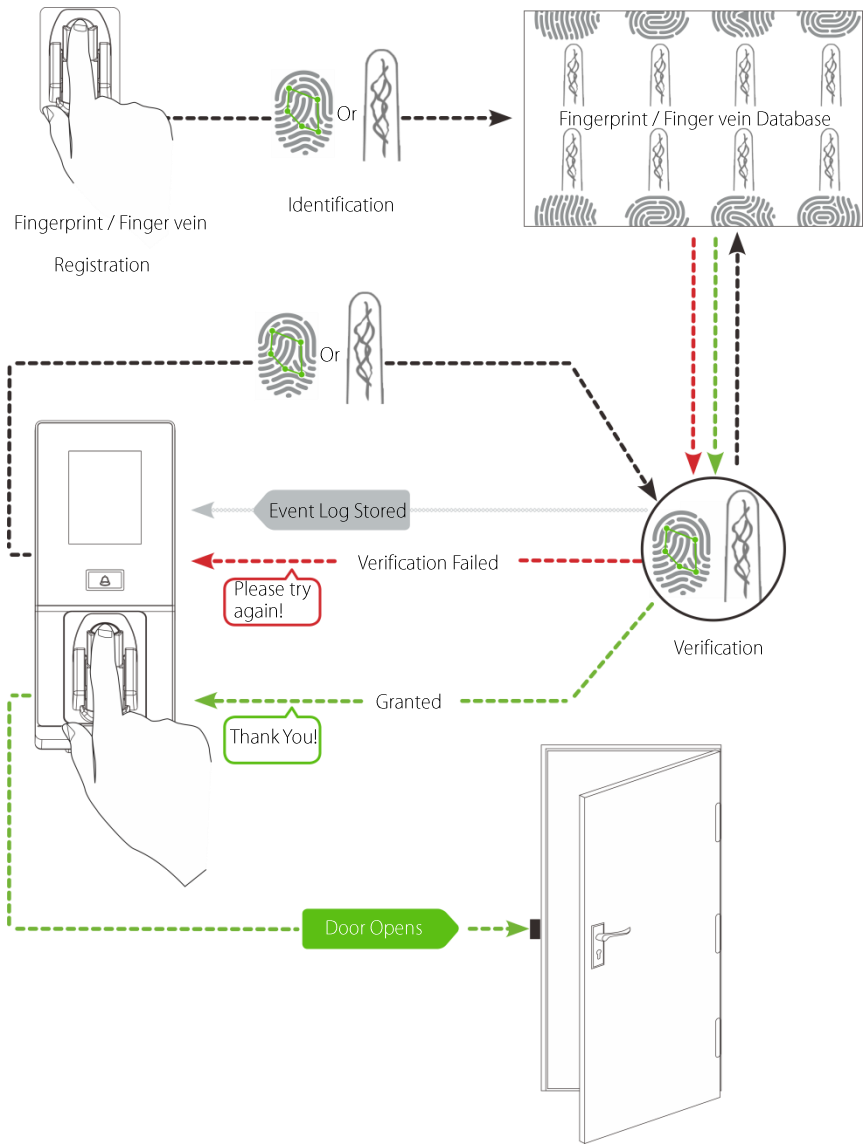

# Registration and Verification

**Note:** During finger vein registration process, fingerprint of the selected finger is also registered.

## ❖ Select a finger to enroll

- It is recommended to use an index finger or a middle finger.
- Thumb, ring or little finger are relatively difficult to place in the correct position

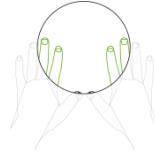

## ❖ Finger Placement Position

- In order to read your fingerprint and finger vein data, touch the front side of finger vein reader with fingertip.
- The device starts collecting data once the finger root touches the finger vein reader.

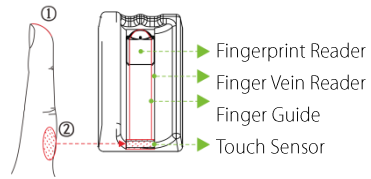

## ❖ Verification Steps

①

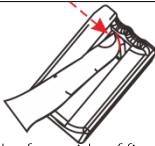

Touch the front side of finger vein reader with fingertip, then press your finger upon the finger vein reader.



Place the finger according to the finger guide.



Finger-tip must touch the front of finger vein reader in order to properly collect fingerprint and finger vein images.

②

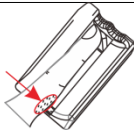

Touch the reader with finger root.

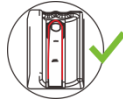

Improper positioning of finger will affect the proper collection of fingerprint and finger vein images.



③

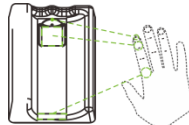
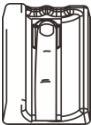

The device starts collecting data once the finger root touches the finger vein reader. Remove finger after “beep” sound appears.

## 😊 Note:

- Maintain the natural hand gesture.
- Do not bend your fingers.
- Do not exert finger to press the reader.

# Troubleshooting

## 1. “Invalid time zone” is displayed after verification?

- Contact Administrator to check if the user has the privilege to gain access within that time zone.

## 2. Verification succeeds but the user cannot gain access?

- Check whether the user privilege is set correctly.
- Check whether the lock wiring is correct.

## 3. The Tamper Alarm rings?

- To cancel the triggered alarm mode, carefully check whether the device and back plate are securely connected to each other, and reinstall the device properly if necessary.



# Green Label

ZK Building, Wuhe Road, Gangtou, Bantian, Buji Town,  
Longgang District, Shenzhen China 518129

Tel: +86 755-89602345

Fax: +86 755-89602394

[www.zkteco.com](http://www.zkteco.com)

