

# Finger Vein Access Control device

## Quick Start Guide

Version: 1.0 Date: June 2015

### 1 Overview

#### »Fingerprint & Finger Vein Device

Front



- ▶ Touch screen
- ▶ Card reader
- ▶ Doorbell
- ▶ Fingerprint reader
- ▶ Finger vein reader
- ▶ Finger vein sensor: During registration, after finger touches the sensor, device begins collecting and verifying fingerprint and finger vein.

Left Side:

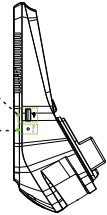

- ▶ USB slot
- ▶ Reset button: Press the button (with sharp-headed tool with less than 2 mm in diameter) after 30-second powering-on to reset device.

#### » FingerVein Device

Front

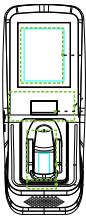

- ▶ Touch screen
- ▶ Card reader
- ▶ Doorbell
- ▶ Finger vein reader
- ▶ Finger vein sensor: During registration, after finger touches the sensor, device begins collecting and verifying finger vein.

Left Side

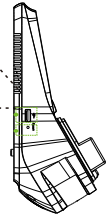

- ▶ USB slot
- ▶ Reset button: Press the button (with sharp-headed tool with less than 2 mm in diameter) after 30-second powering-on to reset device.

Back

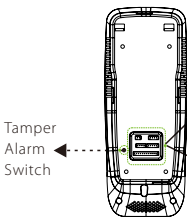

- ▶ Tamper Alarm Switch

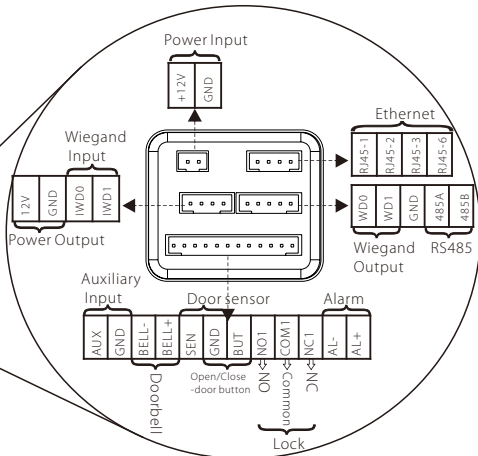

## 2 Cautions

- ① Shut down the power during installation.
- ② 12V/3A power supply is recommended.
- ③ Do not install the device in a place subject to direct sunlight or humidity.
- ④ Please follow the connector instruction for wiring.
- ⑤ Under serious electrostatic environment, please connect the GND before other wirings, in order to prevent static electricity from damaging the device.
- ⑥ It is necessary to connect the FR107 diodes in parallel to the positive and negative poles of the electrical lock, so as to release the self-inductance
- ⑦ Please properly set fingerprint and finger vein verification mode before registering users. Requirement varies with different verification modes:
  - » **Fingerprint & FingerVein Mode:** Both fingerprint and finger vein must be verified to access.
  - » **Fingerprint or FingerVein Mode:** Only fingerprint or finger vein is required to be verified to access.
- ⑧ the functions mentioned with are only featured with particular models of device.

## 3 Installation on Wall

Insert cables to connectors before installation.

- ① Put the mounting template sticker onto the wall, and drill holes according to the symbols.
- ② Fix the back plate onto the wall.
- ③ Install the device onto the back plate.
- ④ Fix the device with locking screws onto the back plate.

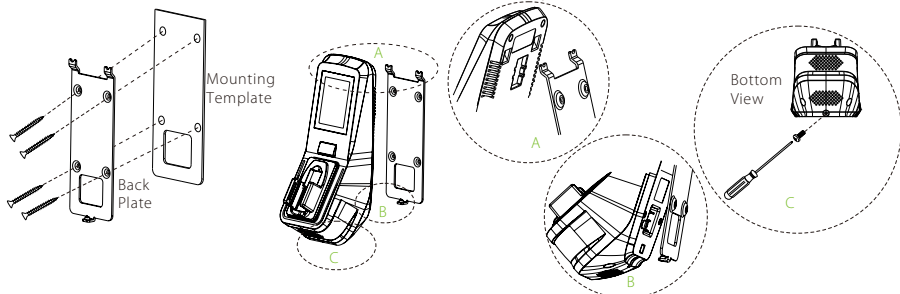

Note: For user heights between 150CM to 170CM, it is recommended to install the device at 140CM above ground (may be modified according to user average height).

## 4 Access Control System Diagram

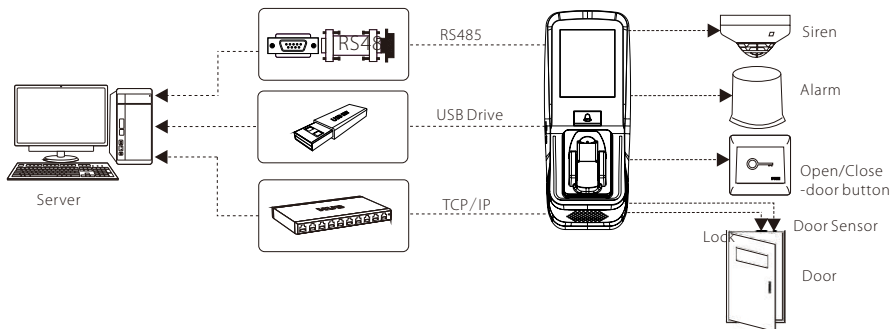

## 5 Power Connection

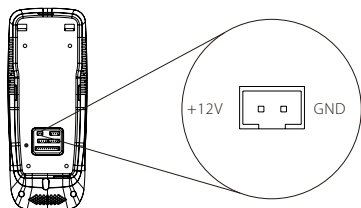

PIN	Slot	Color
1	Power Input +12V	Red
2	Ground GND	Black



The operation power of the device shall be DC12V, the current shall be 3A.

## 6 Connection to Computer softwares via Ethernet

Connection between device and computer (Access control software) via Ethernet. Shown as below:

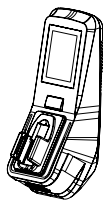

IP Address: 192. 168. 1. 201  
Subnet Mask: 255. 255. 255. 0

IP Address: 192. 168. 1. 39  
Subnet Mask: 255. 255. 255. 0

## 7 Connection to Doorbell, Door Sensor, Open/Close Door Button, Alarm & Siren etc.

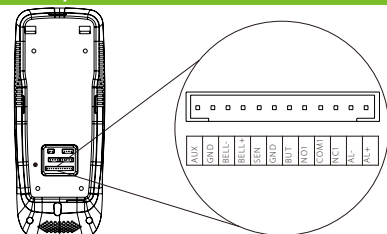

PIN	Slot	Color
1	Auxiliary Input AUX	Brown
2	Ground GND	Purple
3	Doorbell BELL-	Green
4	Doorbell BELL+	Orange
5	Door Sensor SEN	Yellow
6	Ground GND	Red
7	Open/Close Door Button BUT	Blue
8	Normal Open NO1	White
9	Common COM1	black
10	Normal Closed NC1	Grey
11	Alarm AL-	Black
12	Alarm AL+	Red

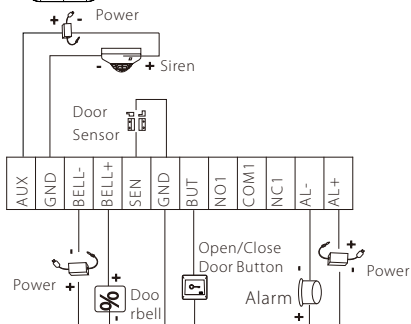

Device can be connected via Auxiliary Input Slot with output switch signal sensors including siren, gas detector, infrared detector and emergency switch.

## 8 Wiegand Input/Output Wiring Instruction

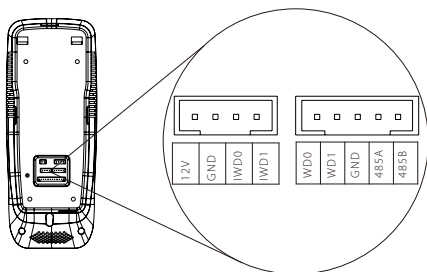

PIN	Slot		Color
1	Power Output	+12V	Red
2	Ground	GND	Black
3	Wiegand Input	IWD0	White
4	Wiegand Input	IWD1	Green
5	Wiegand Output	WD0	Blue
6	Wiegand Output	WD1	Yellow
7	Ground	GND	Black
8	RS485	485A	Grey
9	RS485	485B	Purple

**Wiegand Input:** the device is featured with Wiegand signal input function to connect to card reader or standalone device.

**Wiegand Output:** the device is featured with standard Wiegand signal output function and can be used as reader. The wiring distance between device to controller should not exceed 5m (if longer connection distance or connection with strong interference are necessary, please adopt Wiegand signal extender).

## 9 Finger Vein & Fingerprint Registration and Verification Modes

**Note:** In finger vein registration process, the fingerprint of the selected finger is also registered.

### 1. Suggested finger: first finger, middle finger

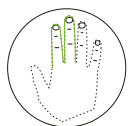

### 2. Finger Placement Position

- In order to read your fingerprint and finger vein data, touch the front side of finger vein reader with fingertip.
- The device starts collecting data once the finger root touches the finger vein reader.

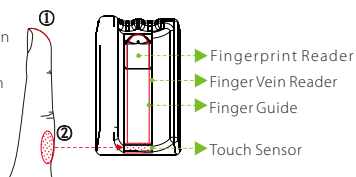

### 3. Verification Steps

①

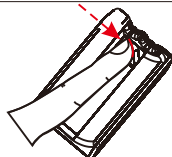

Touch the front side of finger vein reader with fingertip, then press your finger upon the finger vein reader.



Place the finger according to the finger guide.



Finger-tip must touch the front of finger vein reader in order to properly collect fingerprint and finger vein images.

②

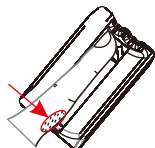

Touch the reader with finger root.

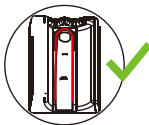

Improper positioning of finger will affect the proper collection of fingerprint and finger vein images.

③

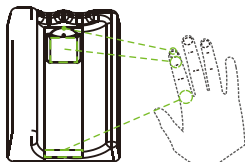



The device starts collecting data once the finger root touches the finger vein reader. Remove finger after "beep" sound appears.

- » Maintain the natural hand gesture.
- » Do not bend your fingers.
- » Do not exert finger to press the reader.



## 10 Main Menu



In the initial interface, click Menu icon  to enter Main Menu. Click Scroll icon  to scroll down to display full menu. Click Scroll icon  again to scroll up.

## 11 Ethernet Setting

In the Main Menu, Click "Comm">"Ethernet" to enter Ethernet Setting.

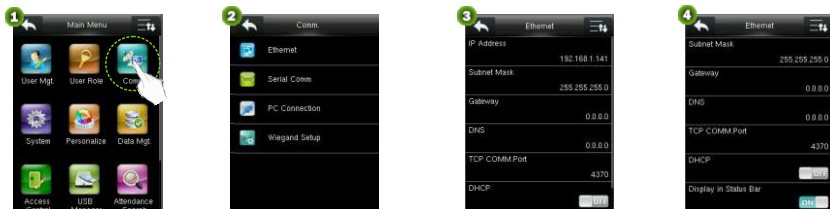

**IP Address:** the default IP address is 192.168.1.201.

**Subnet Mask:** the default subnet mask is 255.255.255.0.

**Gateway:** the default gateway is 0.0.0.0.

**DNS:** the default DNS address is 0.0.0.0.

**TCP COMM.Port:** the default port is 4370.

**DHCP:** Dynamic Host Configuration Protocol, which is to dynamically allocate IP addresses for client via server. If DHCP is enabled, IP cannot be set manually.

**Display in Status Bar:** To enable or disable displaying Network Connection Icon in Status Bar .

## 12 System Setting

Click "System" in Main Menu to enter System Setting.



**Date Time:** To set date & time.

**Access Logs Setting**★: To set Access Log parameters according to personal needs.

**FV&FP Parameters:** To set finger vein parameters according to personal needs.

**Reset:** To reset device and system to factory settings.

**USB Upgrade:** To upgrade device's firmware program through Upgrade documents in USB.

**Note:** User messages and settings of Access Control interface are not deleted after being reset to factory setting.

## 13 Access Control Management

Click "Access Control" in Main Menu to enter Access Control Management interface.

Users can open locks only upon these requirements are met:

1. The access time should fall into either the use's individual time zone or group time zone.
2. User's group must be in the access combo (when there are other groups in the same access combo, verification of members of those groups is also required to unlock the door).

**Access Control Options:** To set Locks and related devices' parameters.

**Time Rule Setting:** To set maximum 50 time rules. Each time rules consists of 7 spaces, each space consists of 3 time slots.

**Holidays:** to set holiday access control and access time.

**Combined Verification:** To set access control combinations.

A combination consist of maximum 5 access control groups.

**Anti-passback Setup:** To prevent passing back which causes risks to security. Once enabled, entry and exit records must be matched in order to open door. Entry anti-passback, exit passback and entry & exit anti-passback functions are available.



### » Access Control Combination Setting

**Note:** ① You may choose not to use Access3.5 Software and to set access control combinations directly in device when using the device for the first time.

- ② If you use Access3.5 Software to set Access Control Combination of the device, you are then not allowed to set access control combinations directly in device.

**E.g.:** Add an access control combination which required 2 persons' verification from both group 1 (set in User Management) and group 2.



1. In "Combined Verification" List, click the desired combination to modify, and enter the interface (shown in 1).
2. Click "+" to ascend, click "-" to descend to set user group no., and click "Confirm" to save and back to "Combined Verification".

**Note:** ① A single Access Control Combination can consist of maximum 5 user groups (in order to open door, both 5 users' verifications are required).

② If the combination is set as shown in 3, a user from group 2 must obtain verifications of 2 users from group 1 in order to open door.

③ Set all group no. to zero to reset access control combination.

## 14 Add Users

In Main Menu interface, click "User Mgt." -> "New User" to enter "New User."

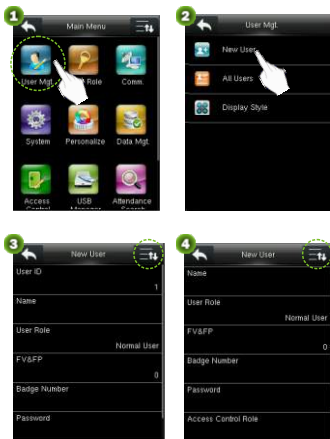

**User ID:** to insert user ID (1 -9 digits).

**Name:** to set user name (1-24 characters; a Chinese character equals two characters).

**User Role:** to set user's authority. Users are default set as ordinary users and can be modified to Admin. Users are only allowed to be verified by finger vein, fingerprint, card or password, while Admins are authorized to enter Main Menu apart from normal verification functions.

**FV&FP:** to register finger vein and fingerprint.

Suggested to register first finger and middle finger. See 9. Finger Vein & Fingerprint Registration and Verification Modes for reference.

**Badge Number:** to register card no..

**Password:** to register user password (1-8 digits).

**Access Control Role:** to set users' access control authority.

## 15 User Verification

**Note:** the device is by default set as "Fingerprint & Finger Vein Mode", and can be modified to "Fingerprint or Finger Vein Mode". See 7.3 Finger Vein & Fingerprint Parameters Setting in Access Control Finger Vein Series User Manual.

» **Fingerprint & Finger Vein Mode:** Fingerprint+Finger Vein verification to success.

» **Fingerprint or Finger Vein Mode:** Fingerprint or Finger Vein verification to success.

### » Finger Vein & Fingerprint Verification

Place and press finger on the reader properly. "Successfully verified" appears upon successful verification.

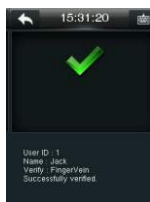

### » Card Verification

Swipe card in swiping area. "Successfully verified" appears upon successful verification.

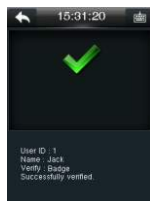

## » Password Verification

- ① Click Keypad Icon  in the initial interface to enter User ID interface.
- ② Enter User ID and click OK, then select pass verification mode (shown in 4).
- ③ Enter password and click OK. "Successfully verified" appears upon successful verification.



## 16 Data Management

In Main Menu interface, click "Data Mgt" to enter Data Management interface.

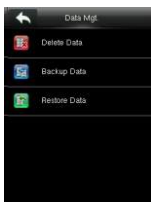

**Delete Data:** to manage device data, including deleting all data, deleting all management authorities, deleting all promotional display and resetting to factory setting.

**Backup Data:** to back up device operation data and related data to computer or Hard Drive.

**Restore Data:** to restore data saved in Computer or Hard Drive to the device.

Please refer to Access Control Finger Vein Seires User Manual.

## 17 Obtain Access Control Report

- ① Connect device to network.
- ② Begin access control device operation (e.g. Access3.5)
- ③ Add device to the access control software to obtain device data and event logs, check access control events, and generate reports.

Note: Please refer to the attached Access3.5 Access Control Management System User Manual CD.

## 18 Troubleshooting

### ① "Invalid time zone" is displayed after verification

» Contact Administrator to check if the user has the privilege to gain access within that time zone.

### ② Verification succeeds but the user cannot gain access

- » Check whether the user privilege is set correctly
- » Check whether the lock wiring is correct

### ③ The Tamper Alarm rings

» To cancel the triggered alarm mode, carefully inspect whether the device is properly installed, and reinstall the device properly if necessary.