

INSTALLATION GUIDE

2.4 Inch TFT Terminal

Time Attendance & Access Control

Optional accessories



Wiegand Card Reader



Prox Card



FR1200 FP Reader



K1-1 Exit Button



Door Lock



Door Sensor

Safety Precautions

The following precautions are to keep user's safe and prevent any damage. Please read carefully before installation



Do not install the device in a place subject to direct sun light, humidity, dust or soot.



Do not place a magnet near the product. Magnetic objects such as magnet, CRT, TV, monitor or speaker may damage the device.



Do not place the device next to heating equipment.



Be careful not to let liquid like water, drinks or chemicals leak inside the device.



Do not let children touch the device without supervision.



Do not drop or damage the device.



Do not disassemble, repair or alter the device.



Do not use the device for any other purpose than specified.



Clean the device often to remove dust on it. In cleaning, do not splash water on the device but wipe it out with smooth cloth or towel.

Contact your supplier in case of a problem.

Product PIN Diagram

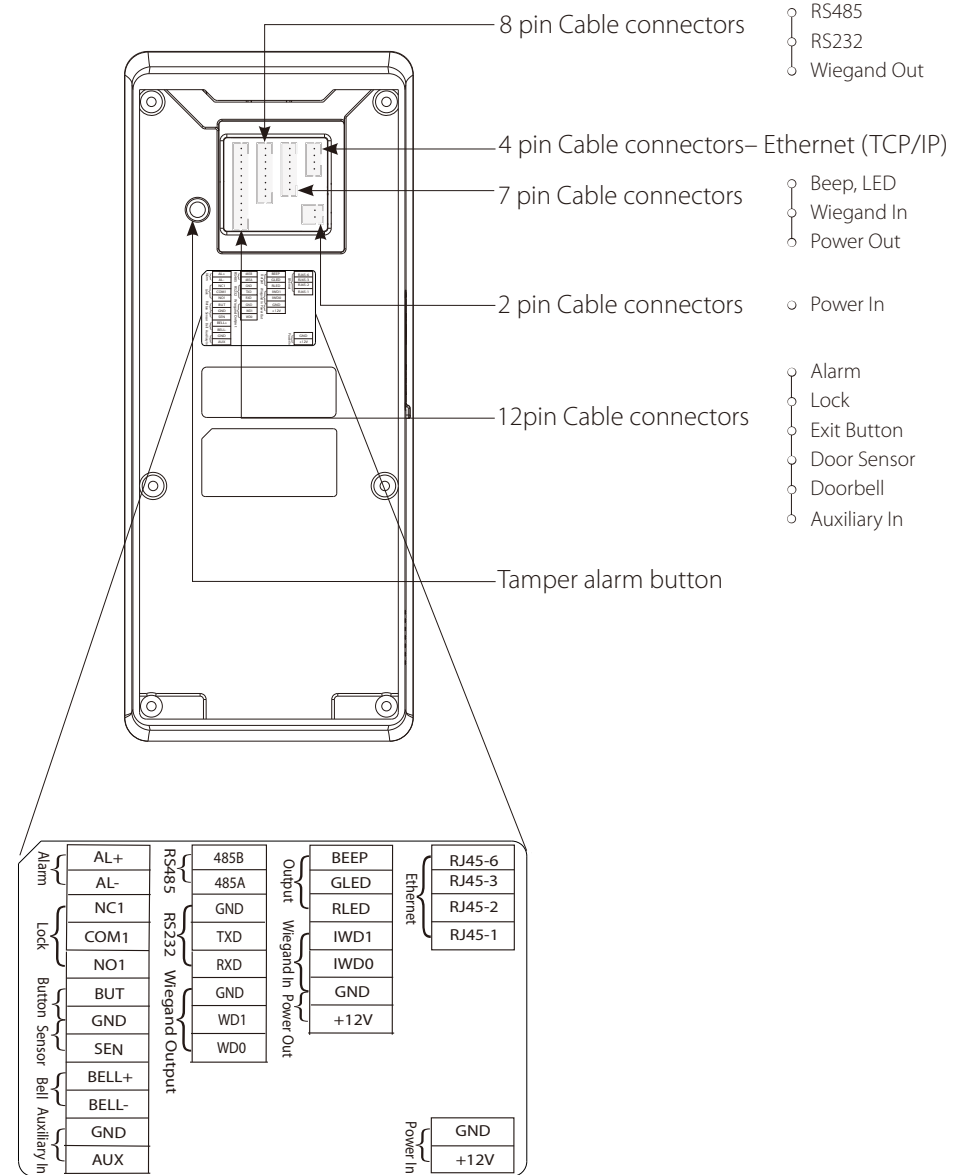
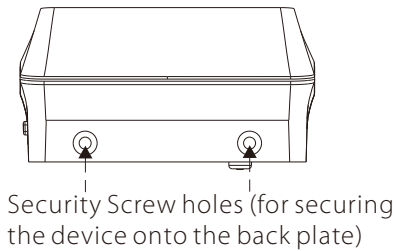
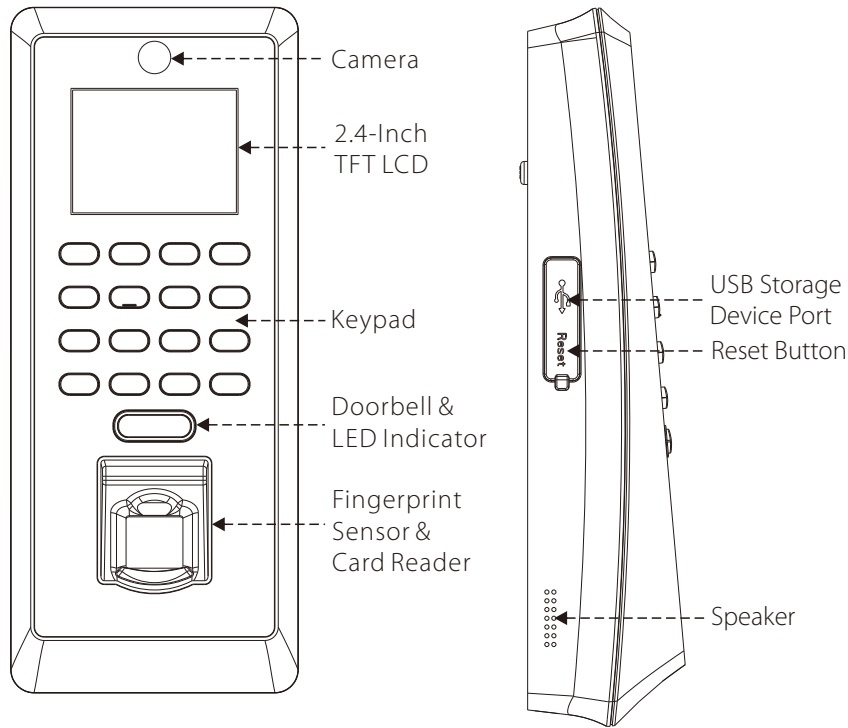

Product Dimension

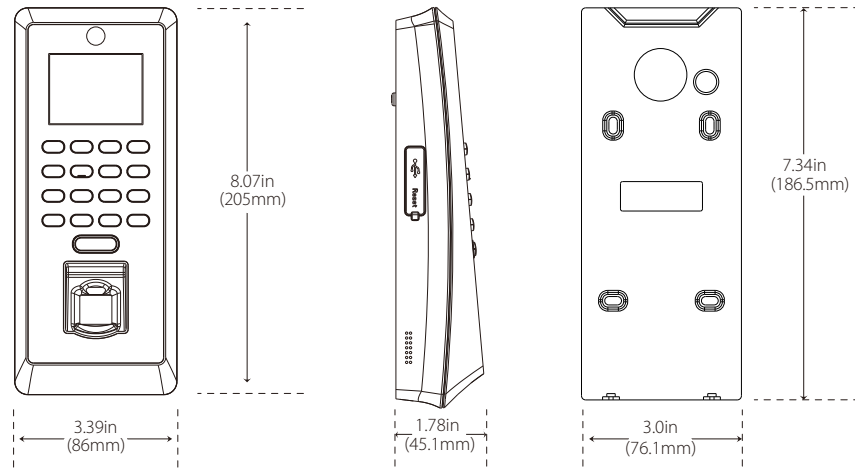

Cables and Connectors

Digital input and Relay output

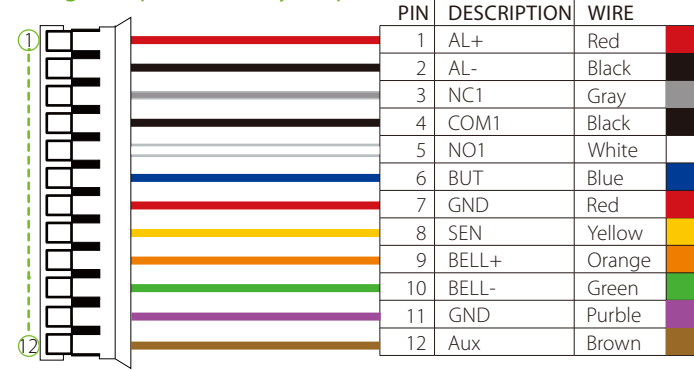

- Alarm
- Lock
- Exit Button
- Door Sensor
- Doorbell
- Auxiliary In

Wiegand output and RS485

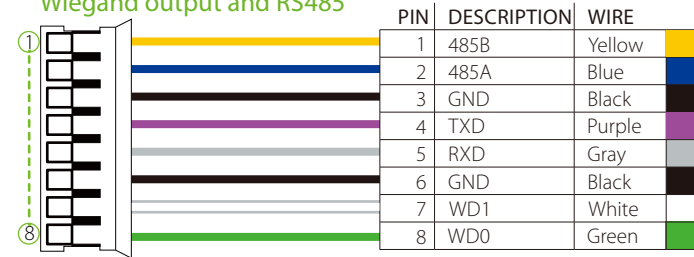

- RS485
- RS232
- Wiegand Out

Wiegand input and Power out

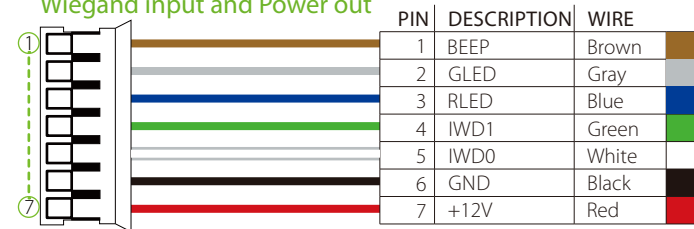

- Beep
- LED
- Wiegand Input
- Power Out

Ethernet

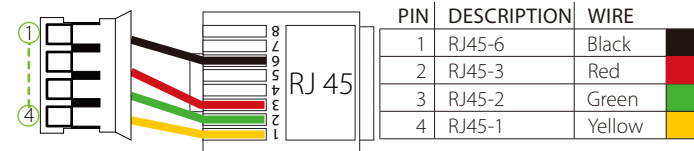

- TCP/IP

Power

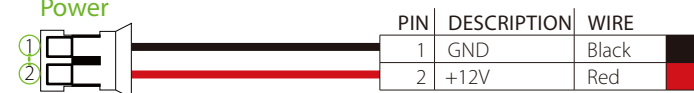

- Power In

Mounting the device onto the Wall

Fix the back plate onto the wall using wall mounting screws

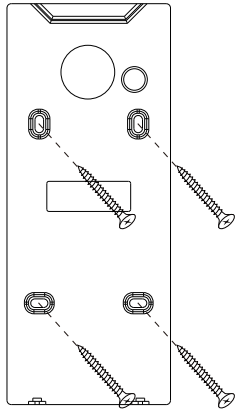

We recommend drilling the mounting plate screws into solid wood (i.e. stud/beam). If a stud/beam cannot be found, then use the supplied drywall plastic mollies (anchors).

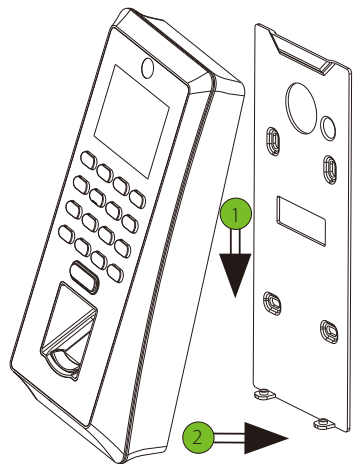

Inserting the device to backplate

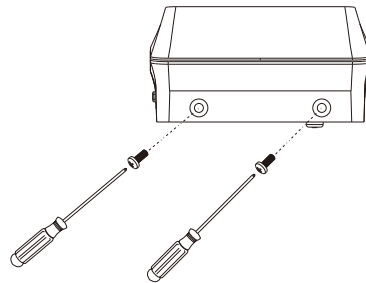

Use security screws to fasten the device to back plate

Power Connection

Without UPS

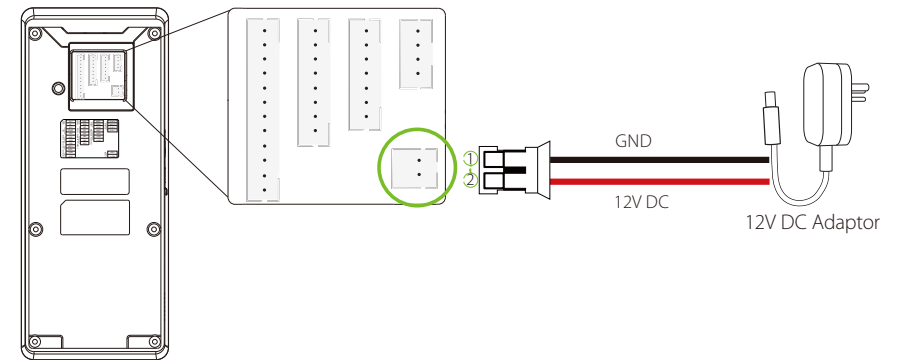

With UPS (Optional)

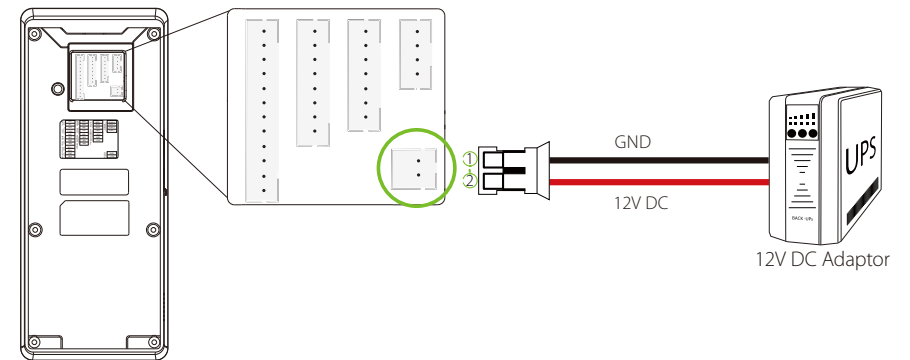

Recommended power supply

- 12V \pm 10%, at least 500mA.
- To share the power with other devices, use a power supply with higher current ratings

Ethernet Connection

LAN Connection

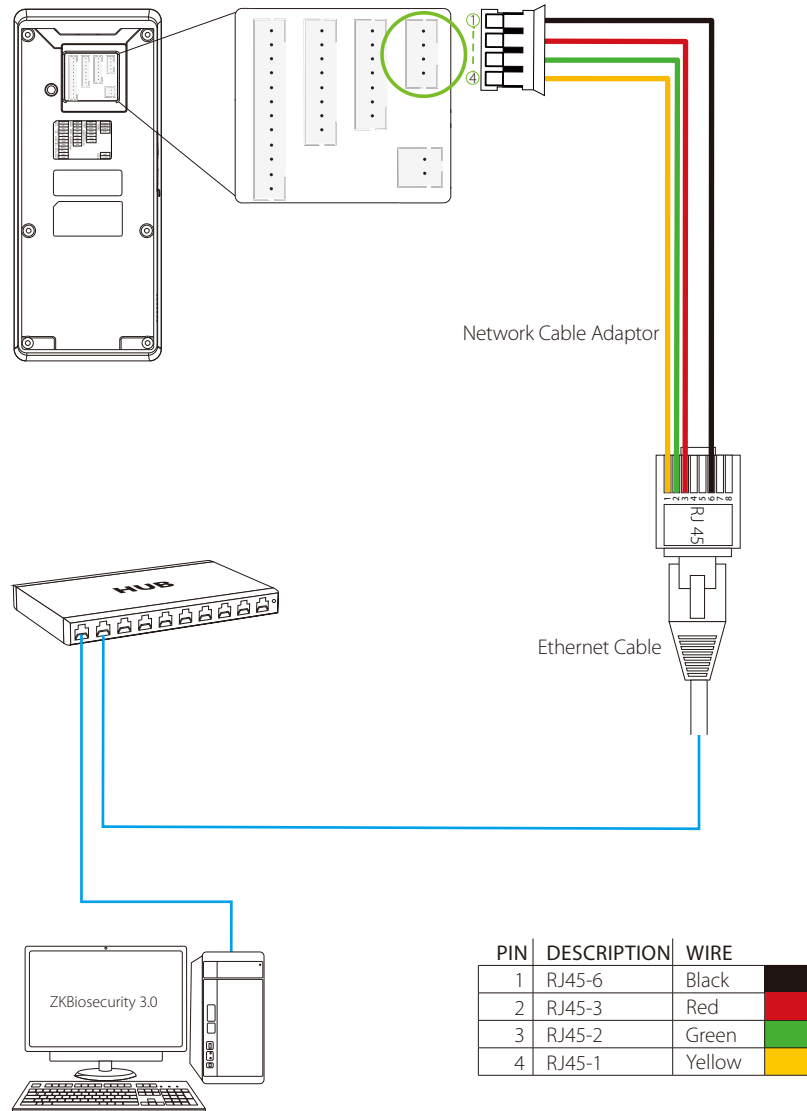

Direct Connection

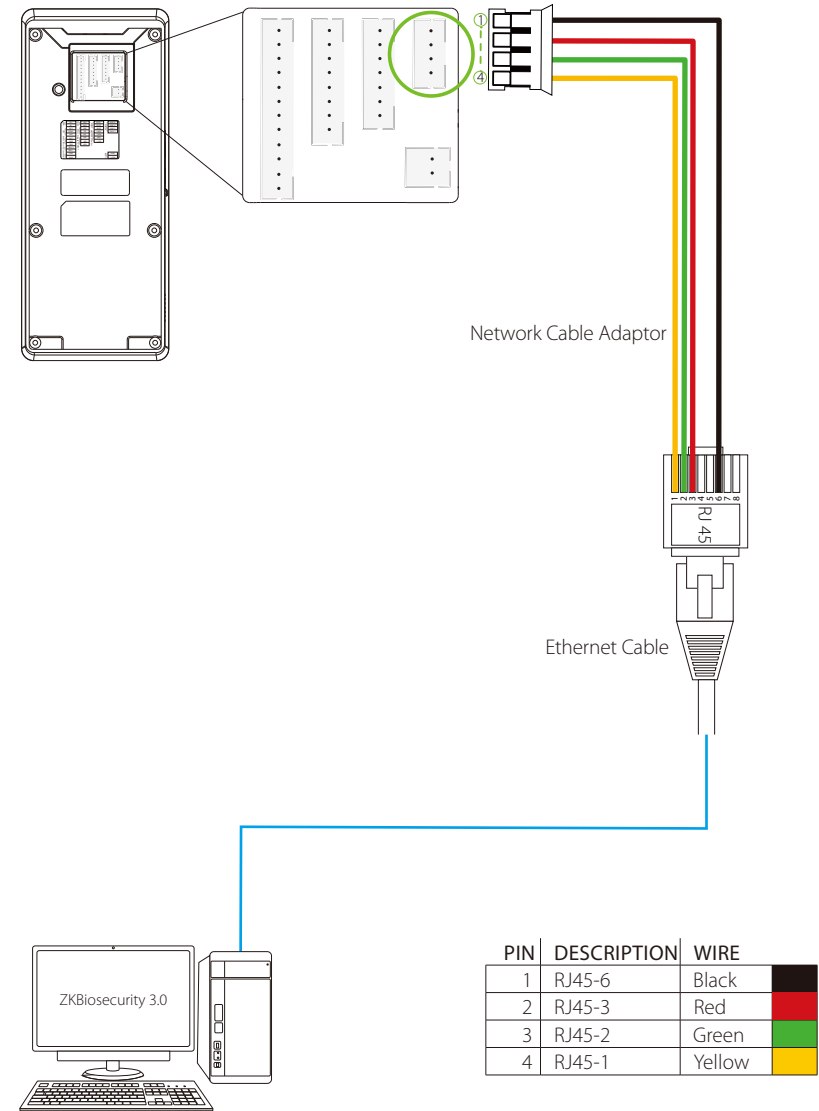

RS485 Connection

PC Connection

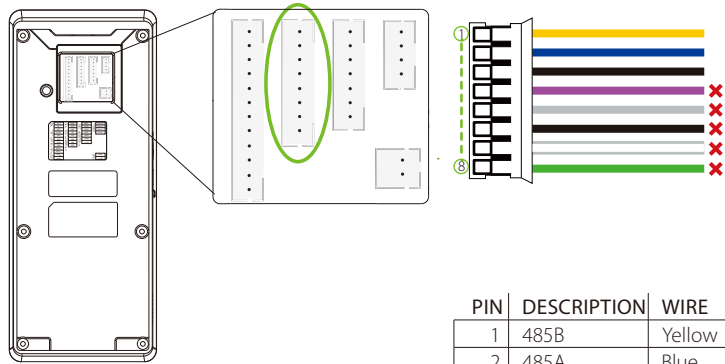

PIN	DESCRIPTION	WIRE
1	485B	Yellow
2	485A	Blue
3	GND	Black
4	TXD	Purple
5	RXD	Gray
6	GND	Black
7	WD1	White
8	WD0	Green

✗ Do not use

Important Notes:

1. RS485 communication wires should be a shielded and twisted pair cable.
2. RS485 communication wires should be connected in a bus cascade instead of a star form, to achieve a better shielding effect by reducing signal reflection during communications.
3. Adjust the communication speed as needed. The signal quality vary depending on wiring conditions, and it maybe necessary to lower the baudrates.
4. The GND Signal may be omitted **if and only if** the GND potential difference is less than $\pm 5V$

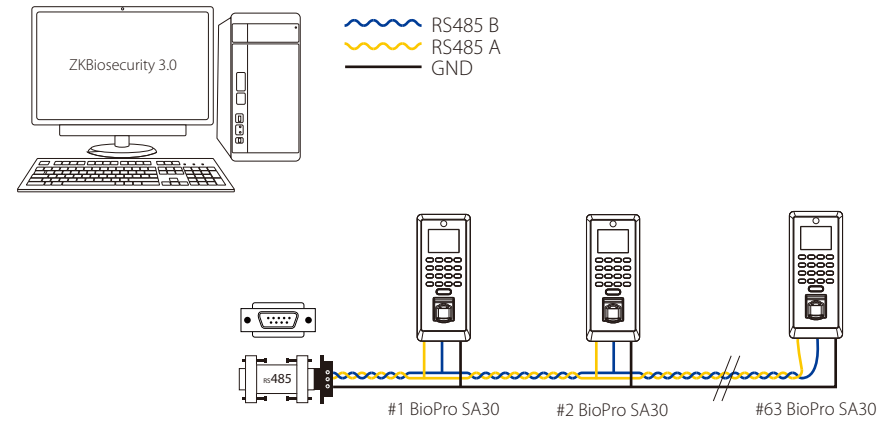

Incorrect RS 485 connections

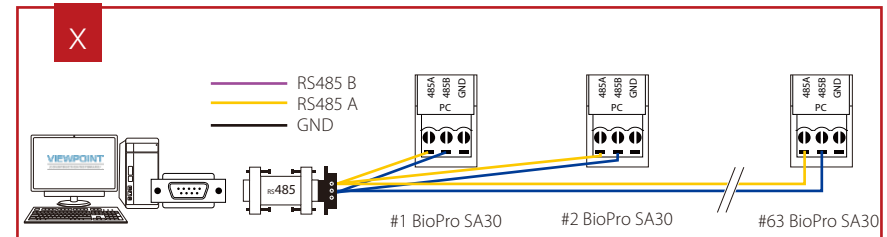
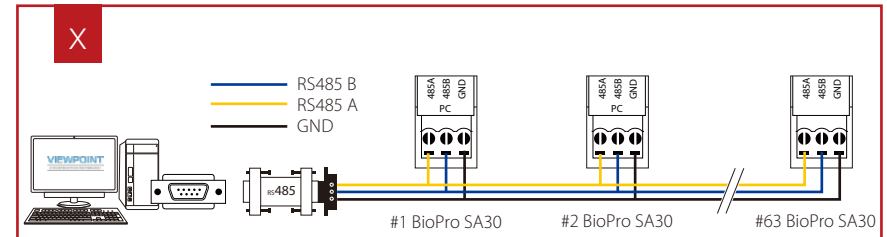

RS485 Connection

FR1200 Connection

PIN	DESCRIPTION	WIRE
1	BEEP	✗ Brown
2	GLEED	✗ Gray
3	RLED	✗ Blue
4	IWD1	✗ Green
5	IWD0	✗ White
6	GND	✗ Black
7	+12V	Red

✗ Do not use

PIN	DESCRIPTION	WIRE
1	485B	Yellow
2	485A	Blue
3	GND	Black
4	TXD	✗ Purple
5	RXD	✗ Gray
6	GND	✗ Black
7	WD1	✗ White
8	WD0	✗ Green

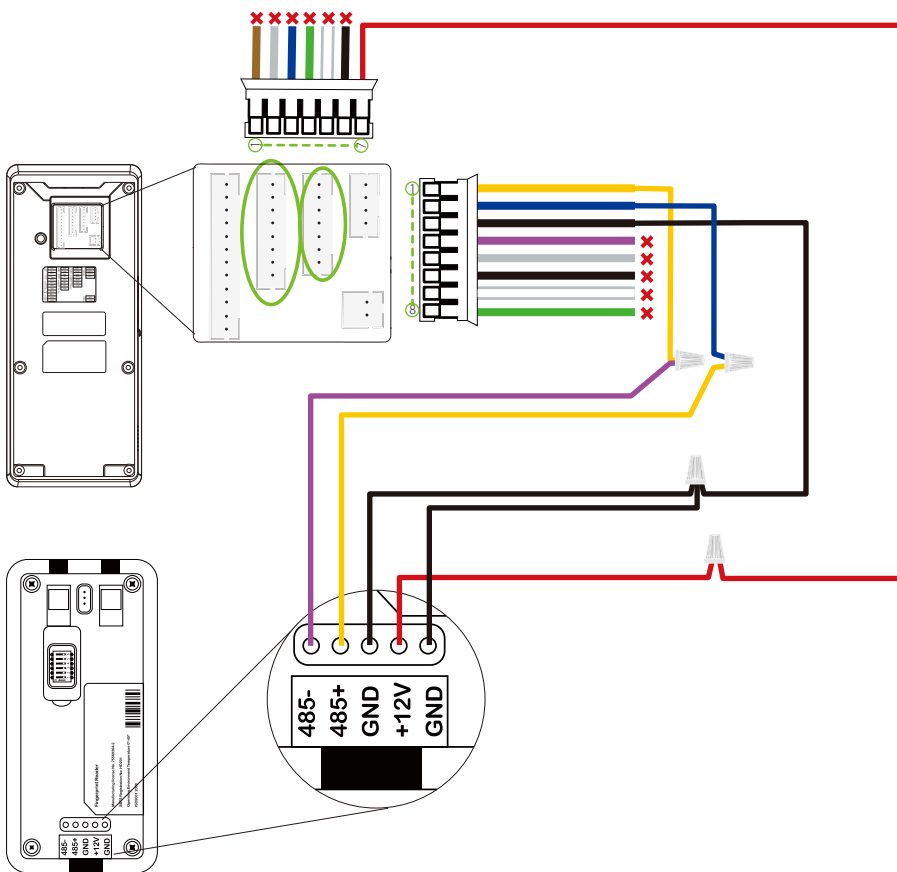

FR1200

System Settings



Select > Comm

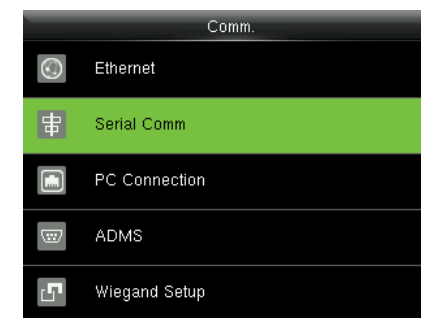

Select > Serial Comm

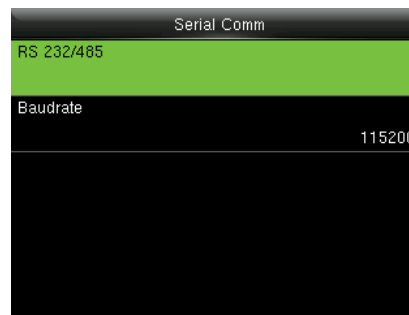

Select > RS232/485

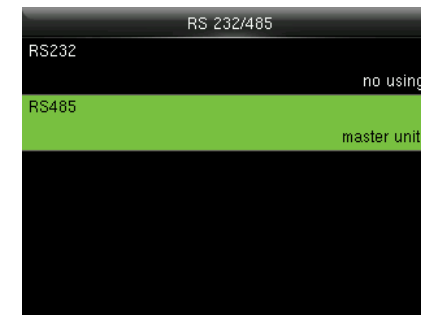

Change > RS485 to (master unit)

DIP Settings

1. There are six DIP switches on the back of FR1200, switches 1-4 is for RS485 address, switch 5 is reserved, switch 6 is for reducing noise on long RS485 cable.
2. If FR1200 is powered from ProCapture terminal, the length of wire should be less than 100 meters or 330 ft.
3. If the cable length is more than 200 meters or 600 ft., the number 6 switch should be ON as below

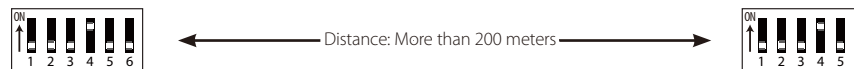

Lock Relay Connection

Device does not Share Power With The Lock

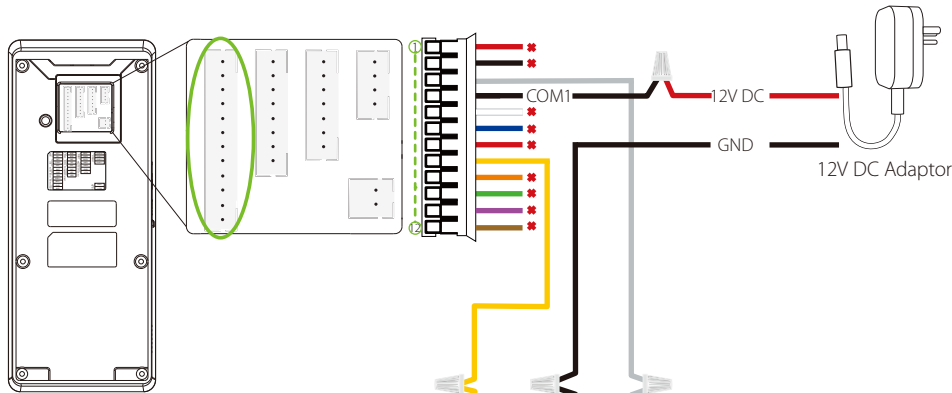

PIN	DESCRIPTION	WIRE
1	AL+	Red
2	AL-	Black
3	NC1	Gray
4	COM1	Black
5	NO1	White
6	BUT	Blue
7	GND	Red
8	SEN	Yellow
9	BELL+	Orange
10	BELL-	Green
11	GND	Purple
12	Aux	Brown

✗ Do not use

Normally Closed Lock

Notes:

1. The system supports **NO LOCK** and **NC LOCK**. For example the **NO LOCK** (normally open at power on) is connected with '**NO1**' and '**COM1**' terminals, and the **NC LOCK** (normally close at power on) is connected with '**NC1**' and '**COM1**' terminals.
2. When electrical lock is connected to the Access Control System, you must parallel one FR107 diode (equipped in the package) to prevent the self-inductance EMF affecting the system.

⚠ Do not reverse the polarities.

Device Shares Power With The Lock

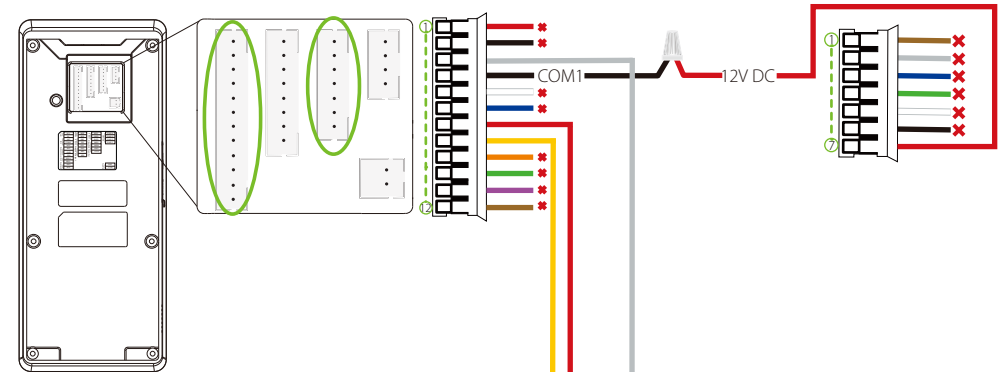

PIN	DESCRIPTION	WIRE
1	AL+	Red
2	AL-	Black
3	NC1	Gray
4	COM1	Black
5	NO1	White
6	BUT	Blue
7	GND	Red
8	SEN	Yellow
9	BELL+	Orange
10	BELL-	Green
11	GND	Purple
12	Aux	Brown

✗ Do not use

Normally Closed Lock

Wiegand Output Connection

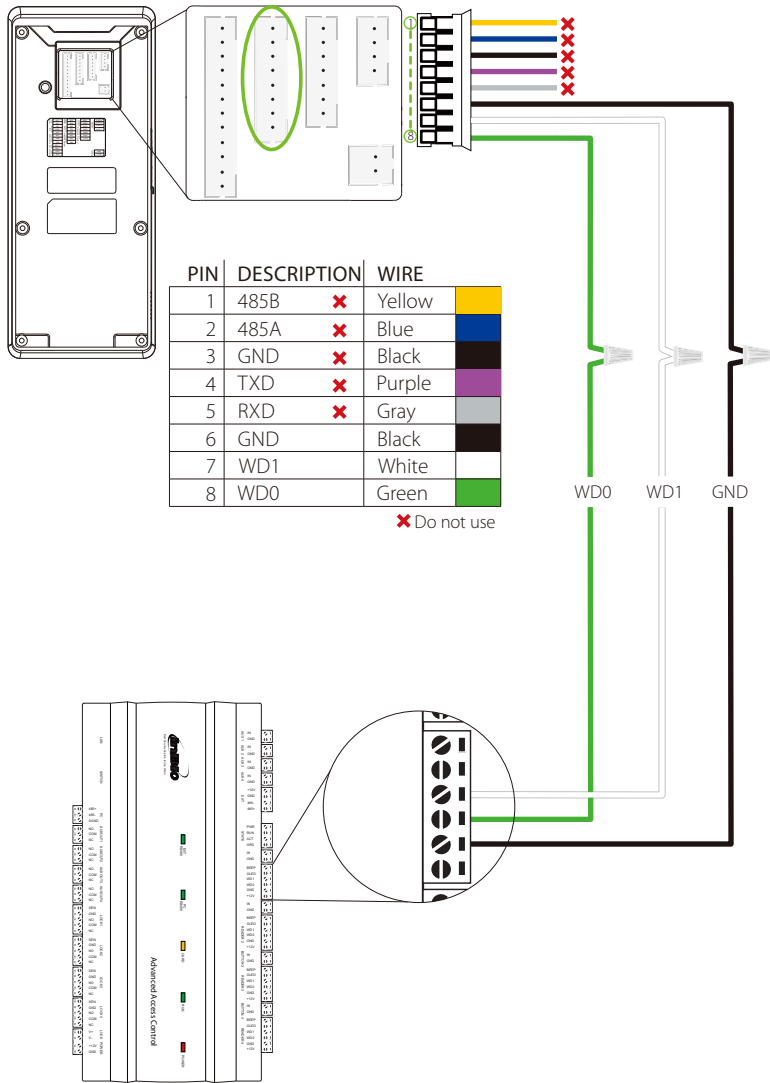

Standalone Installation

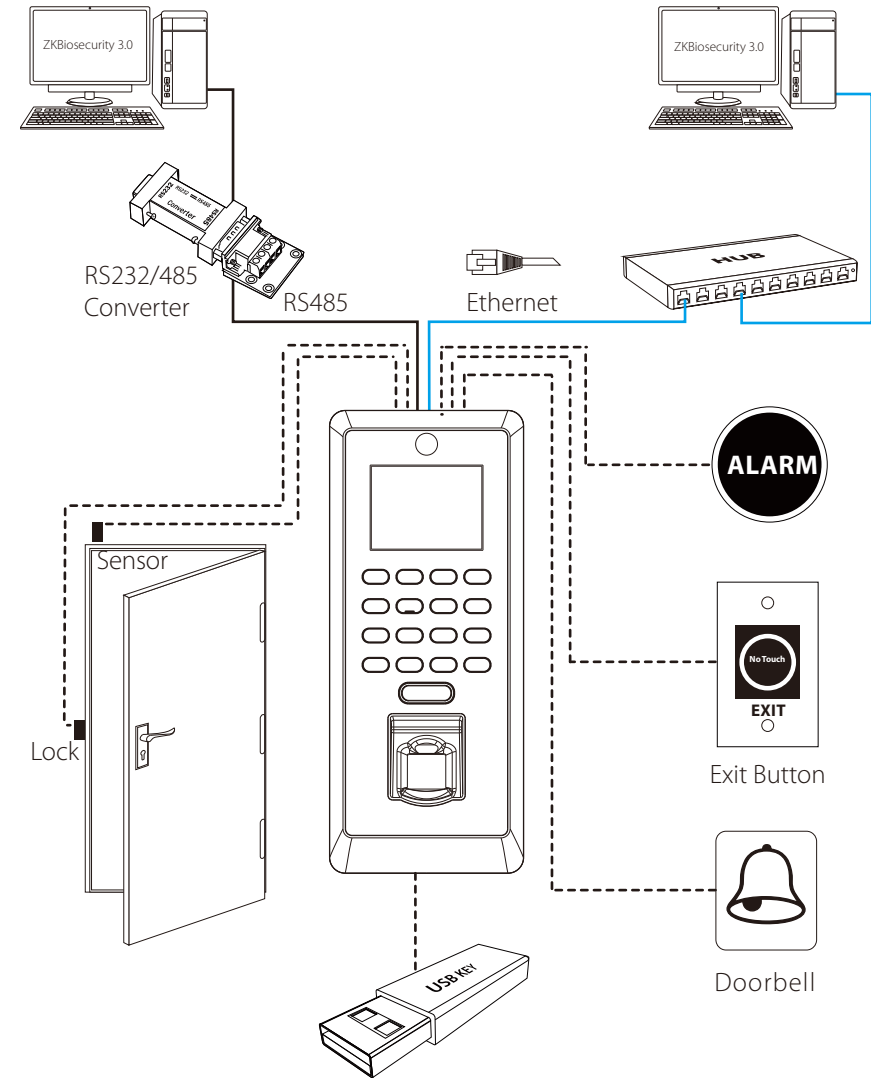

Third Party Controller

Wiegand Output Connection

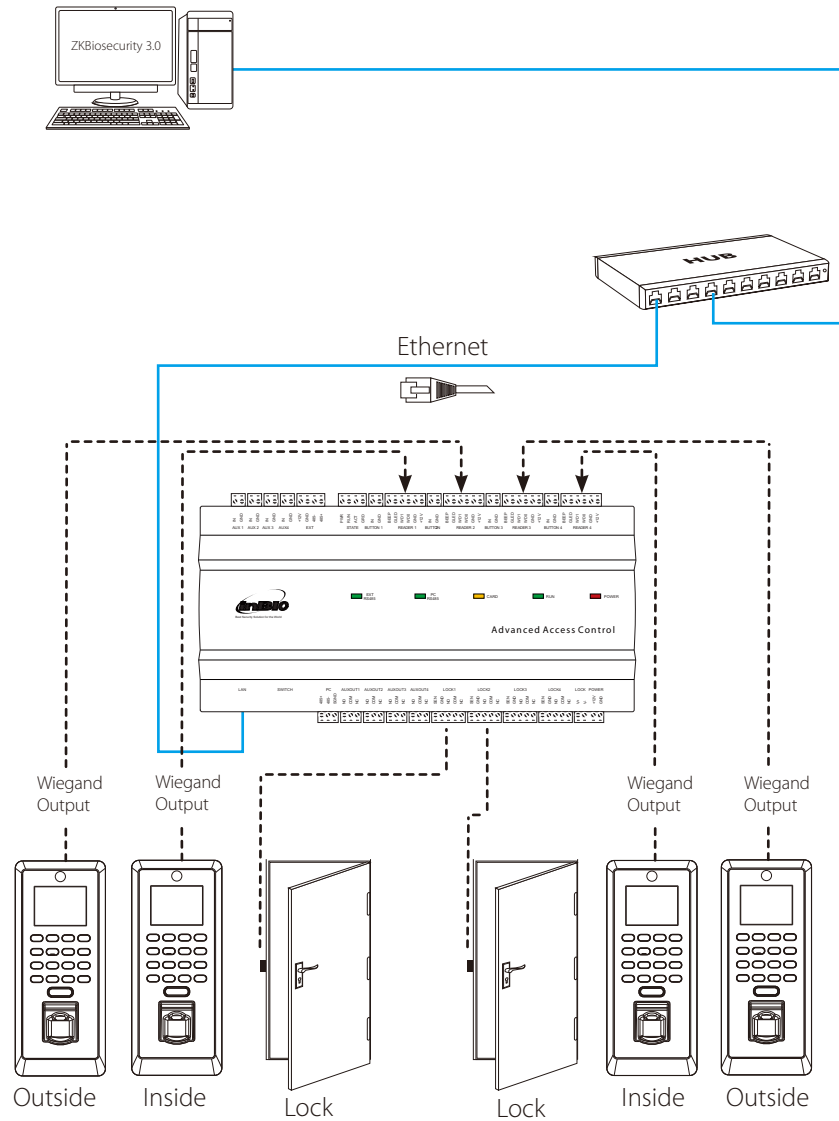

How Does BioPro SA30 work

Fingerprint must be registered first by any finger print reader

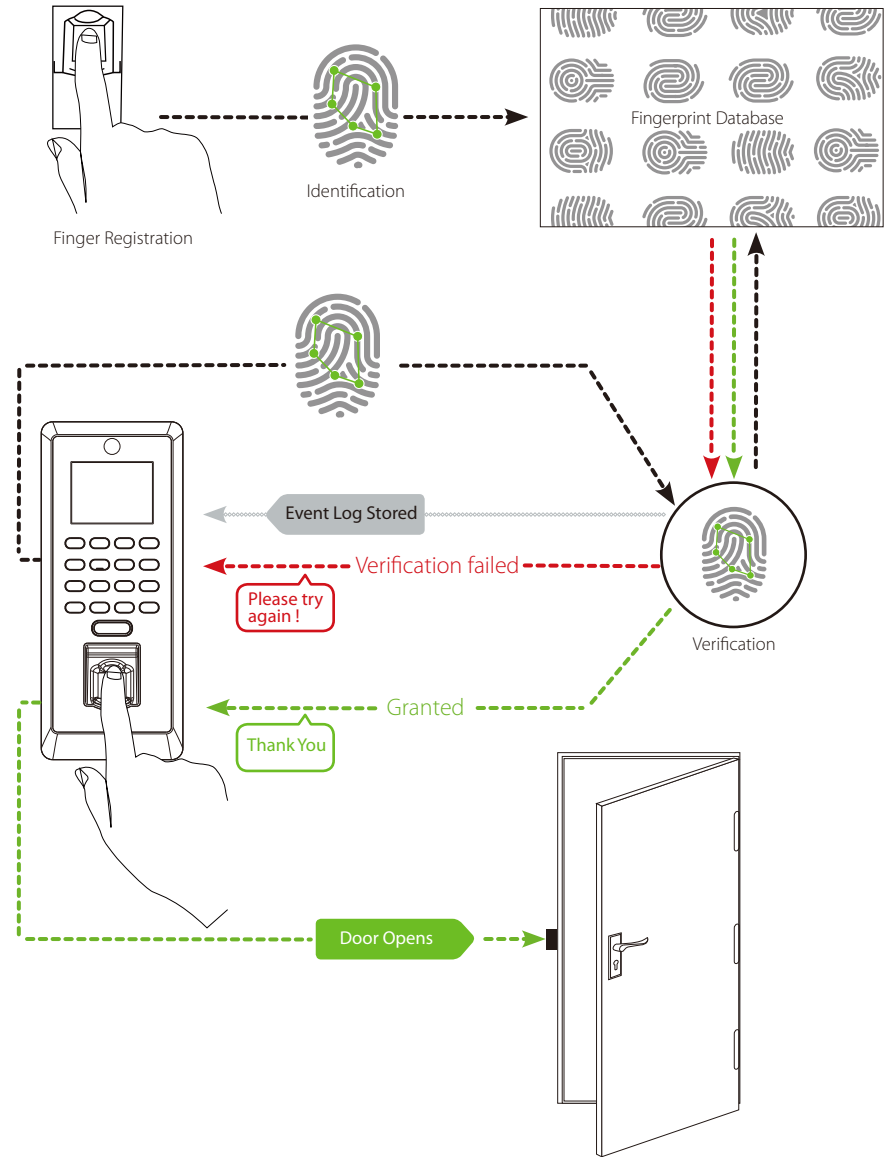

How to Place a Finger on Scanner

ZKTeco's fingerprint readers will give optimal results for fingerprint matching if the following recommendations and suggestions are followed.

Select a finger to enroll

- It is recommended to use an index finger or a middle finger.
- Thumb, ring or little finger are relatively difficult to place in the correct position

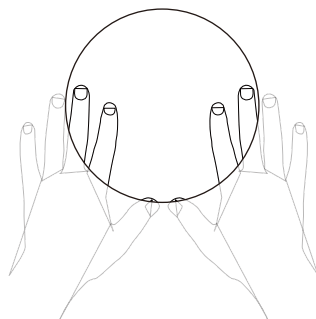

How to place a finger on a sensor

- Place a finger such that it completely covers the sensor area with maximum contact.
- Place core of the fingerprint at the center of the sensor. The core of a fingerprint is a center where the spiral of ridges is dense. (Usually core of fingerprint is the opposite side of the lower part of a nail.)
- Place a finger such that the bottom end of a nail is located at the center of a sensor.

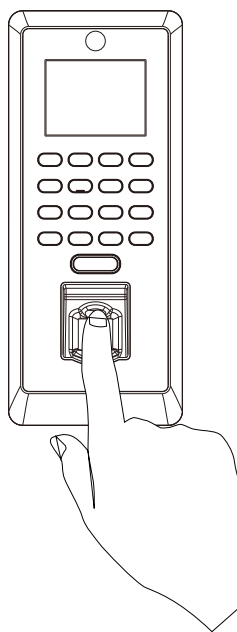

DO NOT place the finger in the following positions

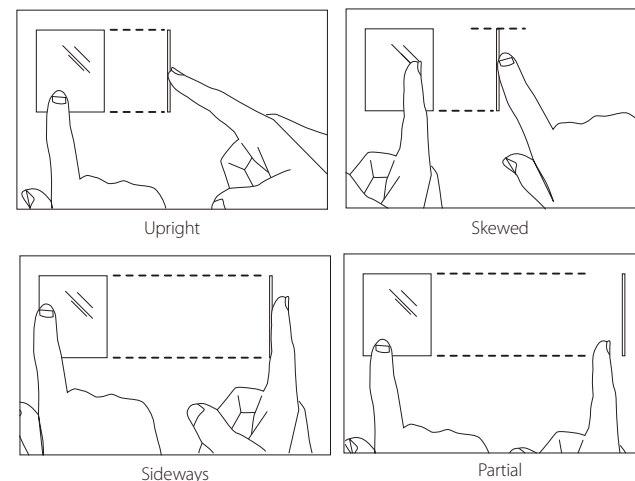

If a finger is placed as shown on the left, only a small area of a finger is captured. So it is recommended to place a finger as shown on page 21.

Tips for different fingerprint conditions

- ZKTeco's fingerprint products are designed to verify fingerprints with highest security irrespective of the conditions of the skin of the finger. However, in case a fingerprint is not read on the sensor, please refer to the followings tips.
 - If a finger is stained with sweat or water, scan after wiping moisture off.
 - If a finger is covered with dust or impurities, scan after wiping them off.
 - If a finger is too dry, please blow some warm air from your mouth on the finger tip.

Tips for fingerprint enrollment

- In fingerprint recognition, enrollment process is very important. When enrolling a fingerprint, please try to place the finger correctly with utmost care.
- In case of low acceptance ratio, the following actions are recommended.
 - Delete the enrolled fingerprint and re-enroll the finger.
 - Try another finger if a finger is not easy to enroll due to scar or cuts.
- In case of an enrolled fingerprint cannot be used due to injury or if the hand is full, it is recommended to enroll more than two fingers per user.

Troubleshooting

- 1. Fingerprint can not be read or it takes too long.**
 - Check whether a finger or fingerprint sensor is stained with sweat, water, or dust
 - Retry after wiping off finger and fingerprint sensor with dry paper tissue or a mildly wet cloth.
 - If a fingerprint is too dry, blow on the finger and retry.
- 2. Fingerprint is verified but authorization keeps failing.**
 - Check whether the user is restricted by group or time zone.
 - Check with administrator whether the enrolled fingerprint has been deleted from the device for some reason.
- 3. Authorized but door does not open.**
 - Check whether the lock open duration is set to appropriate time, which opens the lock.
 - Check whether anti-passback mode is in use. In anti-passback mode, only the person who has entered through that door can exit.
- 4. Why device display “system broken” and the alarm is ringing.**
 - Check whether the device and back plate are securely connected to each other. If not, a tamper switch is activated which triggers the alarm and keeps it ringing.
- 5. How to set ProCapture used as fingerprint reader on inBio access controller.**
 - Reeference the Wiegand Output Connection on page 17.
 - Enroll personnel’s PIN in inBio panel as a card
