

User Manual

PL10/ML10

Version: 1.0

Date: Dec., 2014

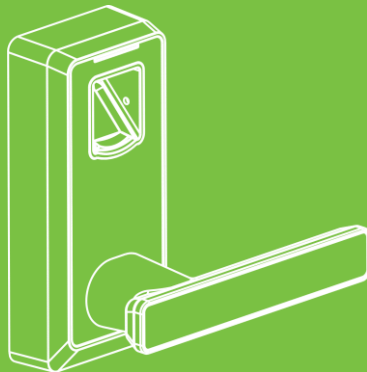

Note

1. New lock is configured to grant ANY fingerprint access to unlock.
2. The lock is equipped with mechanical keys for manual unlocking. Remove mechanical keys from the package and keep them in a safe place.
3. To power on the lock, four alkaline AA batteries (not included) are required. Non-alkaline and rechargeable batteries ARE NOT RECOMMENDED.
4. Please avoid strong light direct to the fingerprint holder, otherwise the infrared sensor might be disturbed.
5. The operation of setting lock has a stand-by time limit of 10 seconds; Without any activity, lock will shut off after 10 seconds.
6. Keep your fingers clean when using this lock.

Appearance

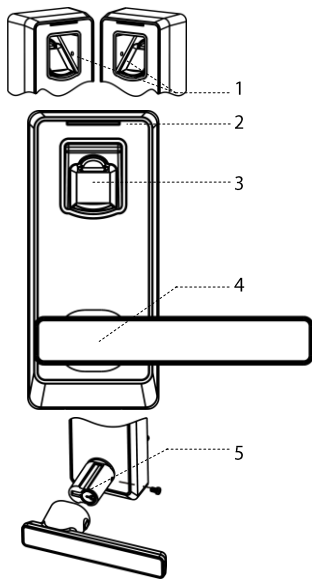

- 1 Infrared sensor hole
- 2 LED
- 3 Fingerprint Sensor
- 4 Handle
- 5 Mechanical key hole
- 6 Battery box cover
- 7 Battery Area
- 8 Button ③ / Temporary User
- 9 Button ① / Admin user
- 10 Back LED
- 11 Button ⊖ / Delete user
- 12 Button ⊕ / Add user
- 13 Reset Button
- 14 Button ② / Normal User
- 15 9V Emergency battery interface

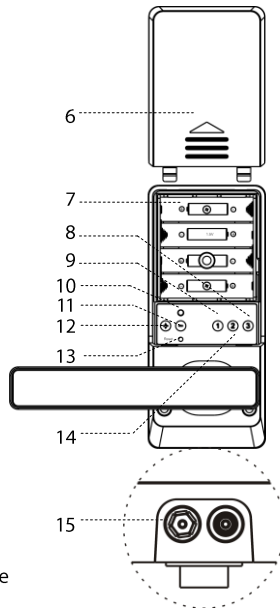

Profile

User Introduction

User Type	Capacity	Privilege
Admin user	10	Add/delete fingerprint; Enable Normal Open; Unlock the door
Normal user	60	Unlock the door; Enable Normal Open
Temporary user	20	Unlock the door; Enable Normal Open

Button Definition

Buttons	Function	Other functions
⊕	Add Users	
⊖	Delete Users	
①	Admin User Group	Enable Normal Open
②	Normal User Group	
③	Temporary User Group	

Lock Status Indication

Lock Status	Indication
Operation success	1 Beep and LED blinks green
Operation failure	2 Beep and LED blinks red
Low battery	7 Beep and LED blinks red 7 times
Unlocking	1 Beep and electric engine makes a rolling sound for the first time, which indicates that the door is open.
Locking	Electric engine makes a rolling sound for the second time, which indicates that the door is closed.

Initialize Lock

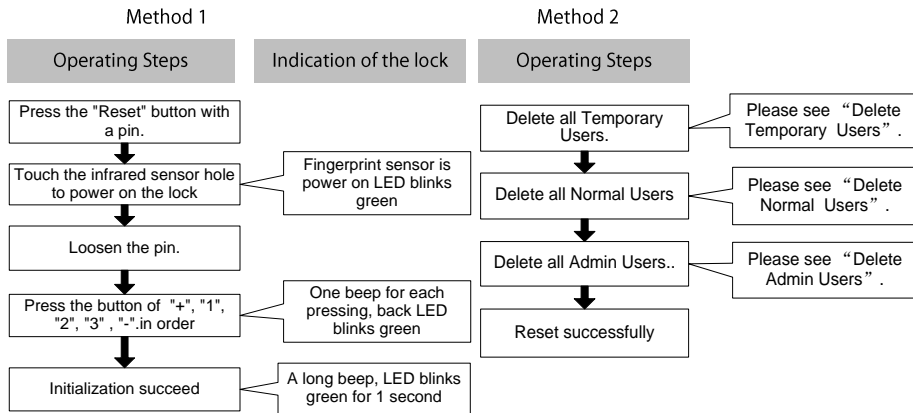

Note: The lock will be restored to factory defaults after initialization, and the door can be opened with any fingerprint.

How to use mechanical key?

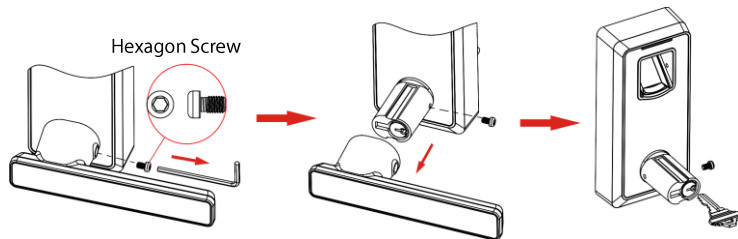

How to use 9V emergency battery?

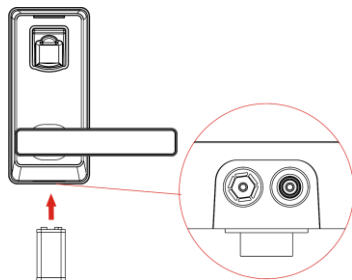

Register First Admin Operation Guide

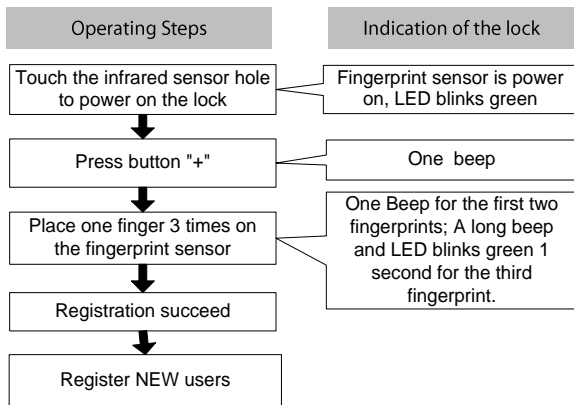

- Note:**
- 1.The first user will be the first Admin automatically at default.
 2. Admin group supports 10 users; you can still register 9 new Admins in next step.
 3. The operating steps of registering new users: Press button 1/2/3 to select user group, then place one new finger 3 times on the fingerprint sensor to continue registering new user.

Register Other Admin Operation Guide

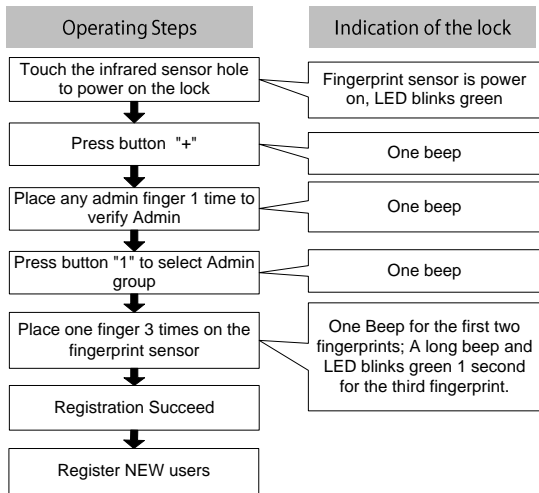

- Note:**
1. Admin group supports 10 users; you can still register 9 new Admin in this step.
 2. The operating steps of Registering new users: Press button 1/2/3 to select user group, then place one new finger 3 times on the fingerprint sensor to continue registering new user.

Register Normal User

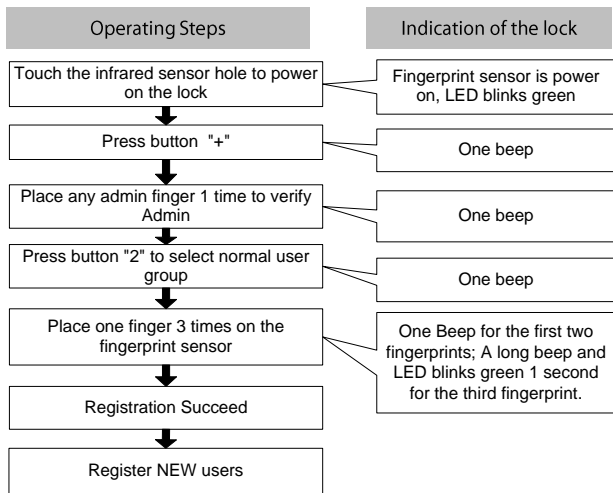

Note: 1. Normal User group supports 60 users.

2. The operating steps of Registering new users: Press button 1/2/3 to select user group, then place one new finger 3 times on the fingerprint sensor to continue registering new user.

Register Temporary User

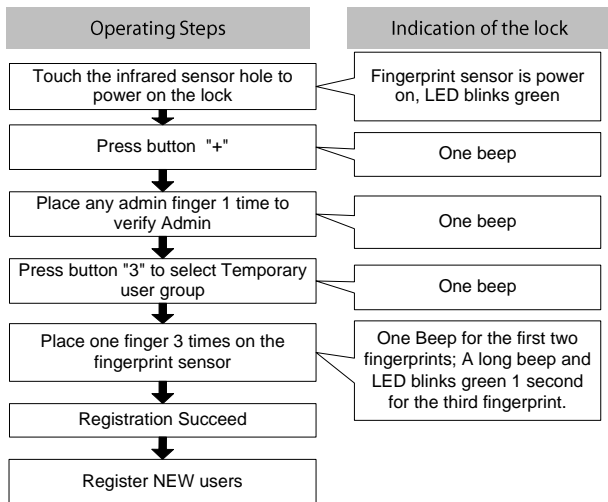

- Note:**
1. Temporary User group supports 20 users.
 2. The operating steps of Registering new users: Press button 1/2/3 to select user group, then place one new finger 3 times on the fingerprint sensor to continue registering new user.

Delete Temporary User Group

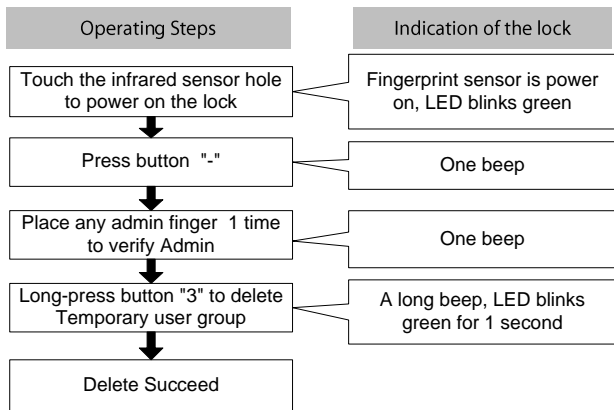

Note: All delete operation is only valid for group.

Delete Normal User Group

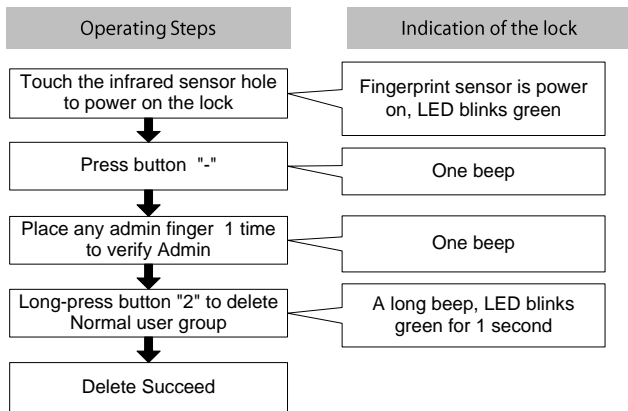

Note: All delete operation is only valid for group.

Delete Admin Group

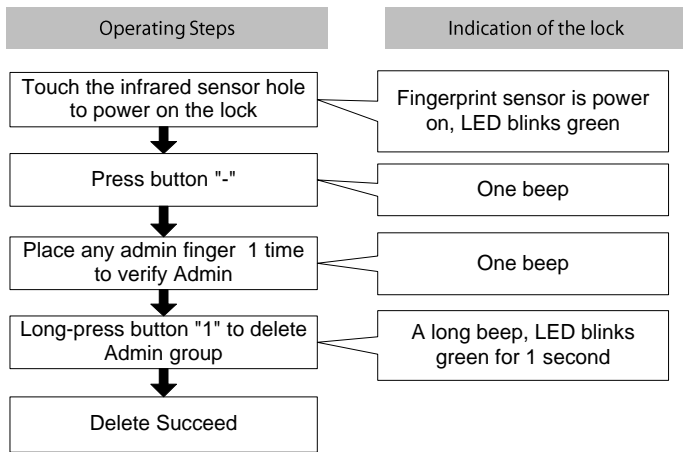

Note: All delete operation is only valid for group.

Enable And Disable Normal Open

Enable Normal Open:

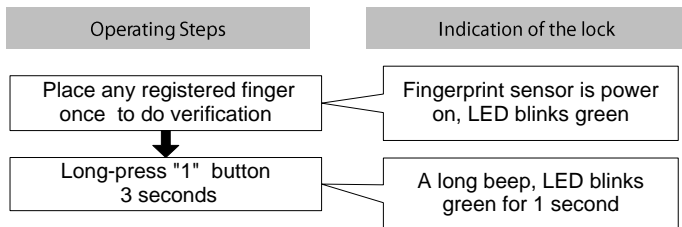

Disable Normal Open:

Place any registered finger 1 time to disable.