

User Manual

BioFace B1 Series

Date: December 2023

Doc Version: 1.0

English

Thank you for choosing our product. Please read the instructions carefully before operation. Follow these instructions to ensure that the product is functioning properly. The images shown in this manual are for illustrative purposes only.



For further details, please visit our Company's website
www.zkteco.com.

Copyright © 2023 ZKTECO CO., LTD. All rights reserved.

Without the prior written consent of ZKTeco, no portion of this manual can be copied or forwarded in any way or form. All parts of this manual belong to ZKTeco and its subsidiaries (hereinafter the "Company" or "ZKTeco").

Trademark

ZKTeco is a registered trademark of ZKTeco. Other trademarks involved in this manual are owned by their respective owners.

Disclaimer

This manual contains information on the operation and maintenance of the ZKTeco equipment. The copyright in all the documents, drawings, etc. in relation to the ZKTeco supplied equipment vests in and is the property of ZKTeco. The contents hereof should not be used or shared by the receiver with any third party without express written permission of ZKTeco.

The contents of this manual must be read as a whole before starting the operation and maintenance of the supplied equipment. If any of the content(s) of the manual seems unclear or incomplete, please contact ZKTeco before starting the operation and maintenance of the said equipment.

It is an essential pre-requisite for the satisfactory operation and maintenance that the operating and maintenance personnel are fully familiar with the design and that the said personnel have received thorough training in operating and maintaining the machine/unit/equipment. It is further essential for the safe operation of the machine/unit/equipment that personnel has read, understood and followed the safety instructions contained in the manual.

In case of any conflict between terms and conditions of this manual and the contract specifications, drawings, instruction sheets or any other contract-related documents, the contract conditions/documents shall prevail. The contract specific conditions/documents shall apply in priority.

ZKTeco offers no warranty, guarantee or representation regarding the completeness of any information contained in this manual or any of the amendments made thereto. ZKTeco does not extend the warranty of any kind, including, without limitation, any warranty of design, merchantability or fitness for a particular purpose.

ZKTeco does not assume responsibility for any errors or omissions in the information or documents which are referenced by or linked to this manual. The entire risk as to the results and performance obtained from using the information is assumed by the user.

ZKTeco in no event shall be liable to the user or any third party for any incidental, consequential, indirect, special, or exemplary damages, including, without limitation, loss of business, loss of profits, business interruption, loss of business information or any pecuniary loss, arising out of, in connection with, or relating to the use of the information contained in or referenced by this manual, even if ZKTeco has been advised of the possibility of such damages.

This manual and the information contained therein may include technical, other inaccuracies or typographical errors. ZKTeco periodically changes the information herein which will be incorporated into new additions/amendments to the manual. ZKTeco reserves the right to add, delete, amend or modify the information contained in the manual from time to time in the form of circulars, letters, notes, etc. for better operation and safety of the machine/unit/equipment. The said additions or amendments are meant for improvement /better operations of the machine/unit/equipment and such amendments shall not give any right to claim any compensation or damages under any circumstances.

ZKTeco shall in no way be responsible (i) in case the machine/unit/equipment malfunctions due to any non-compliance of the instructions contained in this manual (ii) in case of operation of the machine/unit/equipment beyond the rate limits (iii) in case of operation of the machine and equipment in conditions different from the prescribed conditions of the manual.

The product will be updated from time to time without prior notice. The latest operation procedures and relevant documents are available on <http://www.zkteco.com>.

If there is any issue related to the product, please contact us.

ZKTeco Headquarters

Address ZKTeco Industrial Park, No. 32, Industrial Road,
Tangxia Town, Dongguan, China.

Phone +86 769 - 82109991

Fax +86 755 - 89602394

For business related queries, please write to us at: sales@zkteco.com.

To know more about our global branches, visit www.zkteco.com.

About the Company

ZKTeco is one of the world's largest manufacturer of RFID and Biometric (Fingerprint, Facial, Finger-vein) readers. Product offerings include Access Control readers and panels, Near & Far-range Facial Recognition Cameras, Elevator/floor access controllers, Turnstiles, License Plate Recognition (LPR) gate controllers and Consumer products including battery-operated fingerprint and face template-reader Door Locks. Our security solutions are multi-lingual and localized in over 18 different languages. At the ZKTeco state-of-the-art 700,000 square foot ISO9001-certified manufacturing facility, we control manufacturing, product design, component assembly, and logistics/shipping, all under one roof.

The founders of ZKTeco have been determined for independent research and development of biometric verification procedures and the productization of biometric verification SDK, which was initially widely applied in PC security and identity authentication fields. With the continuous enhancement of the development and plenty of market applications, the team has gradually constructed an identity authentication ecosystem and smart security ecosystem, which are based on biometric verification techniques. With years of experience in the industrialization of biometric verifications, ZKTeco was officially established in 2007 and now has been one of the globally leading enterprises in the biometric verification industry owning various patents and being selected as the National High-tech Enterprise for 6 consecutive years. Its products are protected by intellectual property rights.

About the Manual

This manual introduces the operations of **BioFace B1 Series**.

All figures displayed are for illustration purposes only. Figures in this manual may not be exactly consistent with the actual products.

Features and parameters with ★ are not available in all devices.

Document Conventions

Conventions used in this manual are listed below:

GUI Conventions

For Software	
Convention	Description
Bold font	Used to identify software interface template names e.g. OK, Confirm, Cancel.
>	Multi-level menus are separated by these brackets. For example, File > Create > Folder.
For Device	
Convention	Description
< >	Button or key names for devices. For example, press <OK>.
[]	Window names, menu items, data table, and field names are inside square brackets. For example, pop up the [New User] window.
/	Multi-level menus are separated by forwarding slashes. For example, File/Create/Folder.

Symbols





Convention	Description
	This represents a note that needs to pay more attention to.
	The general information which helps in performing the operations faster.
	The information which is significant.
	Care taken to avoid danger or mistakes.
	The statement or event that warns of something or that serves as a cautionary example.

TABLE OF CONTENTS

DATA SECURITY STATEMENT	8
SAFETY MEASURES	8
1 INSTRUCTION FOR USE	10
1.1 FINGER POSITIONING.....	10
1.2 STANDING POSITION, POSTURE AND FACIAL EXPRESSION	10
1.3 FACE TEMPLATE REGISTRATION	11
1.4 STANDBY INTERFACE.....	13
1.5 VIRTUAL KEYBOARD	14
1.6 VERIFICATION MODE.....	16
1.6.1 FINGERPRINT VERIFICATION	16
1.6.2 QR CODE VERIFICATION.....	19
1.6.3 CARD VERIFICATION★	20
1.6.4 FACIAL VERIFICATION.....	22
1.6.5 PASSWORD VERIFICATION	25
1.6.6 COMBINED VERIFICATION	28
2 MAIN MENU	29
3 USER MANAGEMENT.....	31
3.1 USER REGISTRATION.....	31
3.1.1 USER ID AND NAME.....	31
3.1.2 USER ROLE.....	32
3.1.3 FINGERPRINT.....	33
3.1.4 FACE TEMPLATE.....	34
3.1.5 CARD★	35
3.1.6 PASSWORD.....	35
3.1.7 PROFILE PHOTO.....	36
3.1.8 ACCESS CONTROL ROLE.....	37
3.2 SEARCH FOR USERS	37
3.3 EDIT USER.....	38
3.4 DELETE USER.....	39
3.5 DISPLAY STYLE.....	39
4 USER ROLE	41
5 COMMUNICATION SETTINGS.....	43
5.1 NETWORK SETTINGS.....	43
5.2 SERIAL COMM.....	44
5.3 PC CONNECTION	45
5.4 WIRELESS NETWORK★.....	46
5.5 CLOUD SERVER SETTING	49
5.6 WIEGAND SETUP.....	49
5.6.1 WIEGAND INPUT.....	50
5.6.2 WIEGAND OUTPUT	52
5.7 NETWORK DIAGNOSIS.....	53

6	SYSTEM SETTINGS	54
6.1	DATE AND TIME	54
6.2	ACCESS LOGS SETTINGS.....	56
6.3	FACE TEMPLATE PARAMETERS	57
6.4	FINGERPRINT PARAMETERS.....	59
6.5	VIDEO INTERCOM PARAMETERS★.....	60
6.5.1	CONNECTING TO THE ZSMART APP	60
6.5.2	CONNECTING TO SIP	63
6.6	DEVICE TYPE SETTING	69
6.7	SECURITY SETTING.....	70
6.8	USB UPGRADE	71
6.9	FACTORY RESET	72
7	PERSONALIZE SETTINGS	73
7.1	USER INTERFACE SETTINGS	73
7.2	VOICE SETTINGS.....	74
7.3	BELL SCHEDULES	75
7.4	PUNCH STATES OPTIONS★	76
7.5	SHORTCUT KEY MAPPINGS★	77
8	DATA MANAGEMENT	79
8.1	DELETE DATA.....	79
9	ACCESS CONTROL	81
9.1	ACCESS CONTROL OPTIONS	82
9.2	TIME RULE SETTING	84
9.3	HOLIDAYS.....	85
9.4	ACCESS GROUPS.....	86
9.5	COMBINED VERIFICATION	88
9.6	ANTI-PASSBACK SETUP	89
9.7	DURESS OPTIONS	90
10	USB MANAGER	92
10.1	USB DOWNLOAD.....	92
10.2	USB UPLOAD.....	93
10.3	DOWNLOAD OPTIONS★	93
11	ATTENDANCE SEARCH	94
12	WORK CODE★	96
12.1	ADD A WORK CODE	96
12.2	ALL WORK CODES.....	97
12.3	WORK CODE OPTIONS	97
13	AUTOTEST	98
14	SYSTEM INFORMATION	99
15	CONNECTING TO ZKBIO ZLINK WEB	100
15.1	REGISTER ACCOUNT	100
15.2	ADD DEVICE.....	102

15.2.1	SET ORGANIZATION (ADD PERSON).....	102
15.2.2	ADD DEVICE.....	103
15.3	TIME SLOT.....	106
15.3.1	SET TIME SLOT.....	106
15.3.2	SET DOOR ACCESS TIME.....	106
15.3.3	SET GROUP ACCESS TIME.....	107
15.4	SYNCHRONIZE PERSON TO DEVICE.....	108
15.5	USER REGISTRATION.....	111
15.5.1	REGISTER A USER ID AND NAME.....	111
15.5.2	SETTING THE USER ROLE.....	111
15.5.3	REGISTER FINGERPRINT.....	112
15.5.4	REGISTER FACE TEMPLATE.....	114
15.5.5	REGISTER PASSWORD.....	115
15.5.6	REGISTER CARD.....	117
15.6	DATA SEARCH.....	119
15.6.1	DASHBOARD.....	119
15.6.2	EVENT REPORT.....	119
16	CONNECTING TO ZKBIO ZLINK APP.....	120
16.1	REGISTER ACCOUNT.....	120
16.2	ADD PERSON.....	121
16.3	ADD DEVICE.....	122
16.3.1	ADD SITE AND ZONE.....	122
16.3.2	ADD DEVICE.....	123
17	CONNECT TO ZKBIO CVACCESS SOFTWARE.....	126
17.1	SET THE COMMUNICATION ADDRESS.....	126
17.2	ADD DEVICE ON THE SOFTWARE.....	127
17.3	ADD PERSONNEL ON THE SOFTWARE.....	128
17.4	MOBILE CREDENTIAL.....	129
18	CONNECTING TO WIRELESS DOORBELL★.....	132
18.1	CONNECT THE WIRELESS DOORBELL.....	132
18.2	UNBINDING THE WIRELESS DOORBELL.....	132
18.3	SETTINGS.....	133
APPENDIX 1	134
	REQUIREMENTS OF LIVE COLLECTION AND REGISTRATION OF VISIBLE LIGHT FACE TEMPLATES.....	134
	REQUIREMENTS FOR VISIBLE LIGHT DIGITAL FACE TEMPLATE DATA.....	135
APPENDIX 2	136
	PRIVACY POLICY.....	136
	ECO-FRIENDLY OPERATION.....	138

Data Security Statement

ZKTeco, as a smart product supplier, may also need to know and collect some of your personal information to better assist you in using ZKTeco's goods and services, and will treat your privacy carefully by developing a Privacy Policy.

Please read and understand completely all the privacy protection policy regulations and key points that appear on the device before using ZKTeco products.

As a product user, you must comply with applicable laws and regulations related to personal data protection when collecting, storing, and using personal data, including but not limited to taking protective measures for personal data, such as performing reasonable rights management for devices, strengthening the physical security of device application scenarios, and so on.

Safety Measures

The following precautions are to keep the user's safety and prevent any damage. Please read carefully before installation.

1. **Read, follow, and retain instructions** - All safety and operational instructions must be properly read and followed before bringing the device into service.
2. **Do not ignore warnings** - Adhere to all warnings on the unit and in the operating instructions.
3. **Accessories** - Use only manufacturer-recommended or product-sold accessories. Please do not use any other components other than manufacturer suggested materials.
4. **Precautions for the installation** – Do not place this device on an unstable stand or frame. It may fall and cause serious injury to persons and damage to the device.
5. **Service** - Do not try to service this unit yourself. Opening or removing covers may expose you to hazardous voltages or other hazards.
6. **Damage requiring service** - Disconnect the system from the main AC or DC power source and refer service personnel under the following conditions:
 - When cord or connection control is affected.
 - When the liquid was spilled, or an item dropped into the system.
 - If the system is exposed to water and/or inclement weather conditions (rain, snow, and more).
 - If the system is not operating normally under operating instructions.

Just change controls defined in operating instructions. Improper adjustment of other controls may result in damage and involve a qualified technician to return the device to normal operation.

7. **Replacement parts** - When replacement parts are required, service technicians must only use replacement parts provided by the supplier. Unauthorized substitutes can lead to the risk of burns, electric shock, or other hazards.
8. **Safety check** - On completion of service or repair work on the unit, ask the service technician to

perform safety checks to ensure proper operation of the unit.

9. **Power sources** - Operate the system only from the label's power source form. If the sort of power supply to use is unclear, call your dealer.
10. **Lightning** – Can install external lightning conductors to protect against electrical storms. It stops power-ups destroying the system.

The devices should be installed in areas with limited access.



1 Instruction for Use

Before getting into the Device features and functions, it is recommended to be familiar with the below fundamentals.

1.1 Finger Positioning

Recommended fingers: The index, middle, or ring fingers are recommended fingers to use, and avoid using the thumb or pinky, as they are difficult to position correctly onto the fingerprint reader.

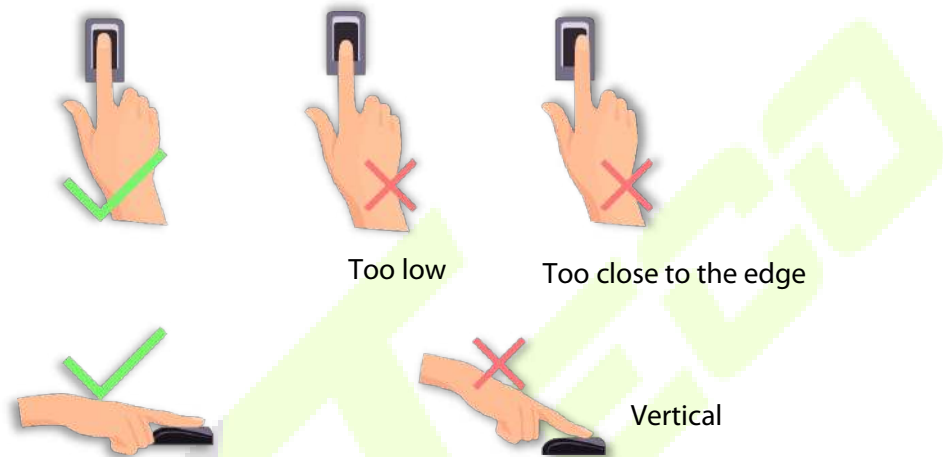

Note: Please use the correct method when pressing your fingers onto the fingerprint reader for registration and identification. Our company will assume no liability for recognition issues that may result from incorrect usage of the product. We reserve the right of final interpretation and modification concerning this point.

1.2 Standing Position, Posture and Facial Expression

- **The recommended distance**

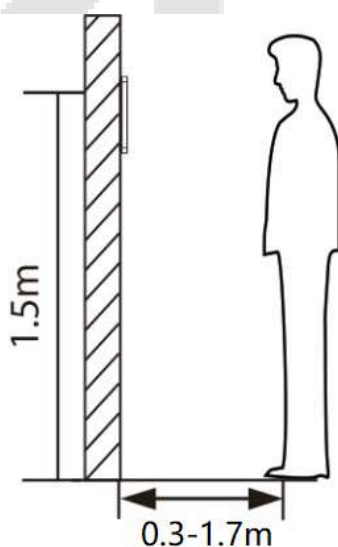

The distance between the device and a user whose height is in a range of 1.55 m to 1.85 m is recommended to be 0.3 m to 1.7 m. Users may slightly move forward or backward to improve the quality of facial images captured.

● **Recommended standing posture and facial expression:**

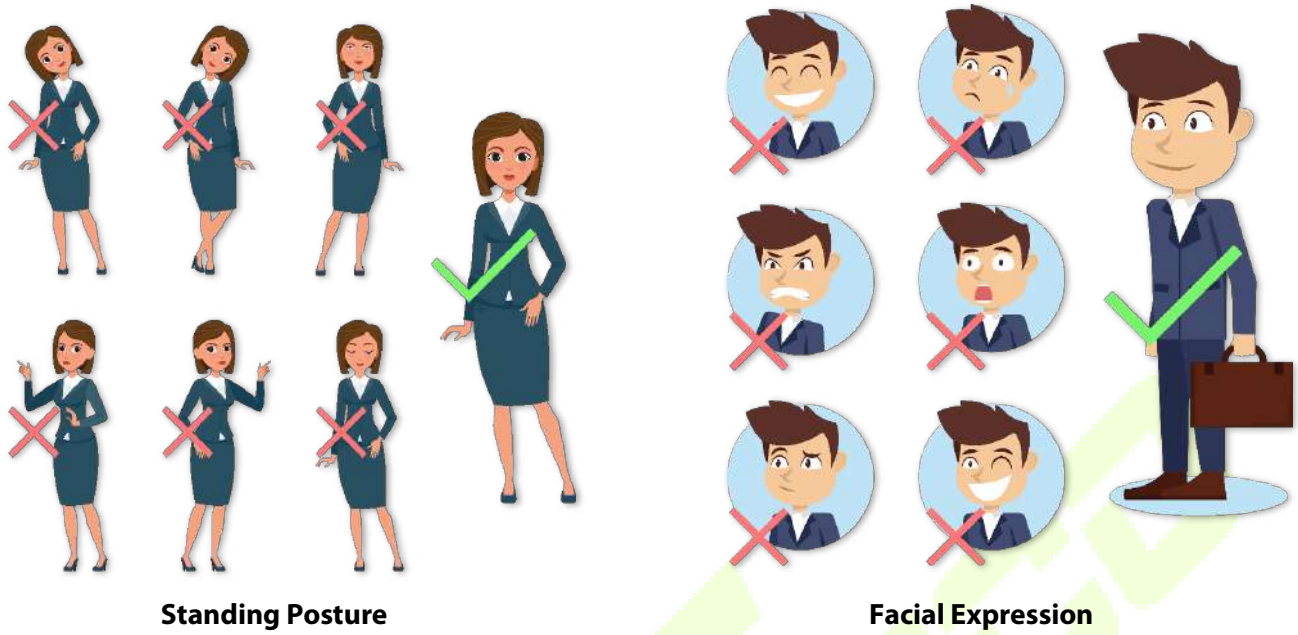

Note: During enrollment and verification, please remain natural facial expression and standing posture.

1.3 Face Template Registration

Please make sure that the face template in the centre of the screen during registration. Please face towards the camera and stay still during face template registration. The screen should look like the image below:



Correct face template registration and authentication method

● Recommendation for Registering a Face Template

- When registering a face template, maintain a distance of 40 cm to 80 cm space between the device and the face template.
- Be careful not to change your facial expression. (Smiling face template, drawn face template, wink, etc.)
- If you do not follow the instructions on the screen, the face template registration may take longer or may fail.
- Be careful not to cover the eyes or eyebrows.
- Do not wear hats, masks, sunglasses, or eyeglasses.
- Be careful not to display two face templates on the screen. Register one person at a time.
- It is recommended for a user wearing glasses to register both face templates with and without glasses.



● Recommendation for Authenticating a Face Template

- Ensure that the face template appears inside the guideline displayed on the screen of the device.
- If the glasses have been changed, authentication may fail. If the face template without glasses has been registered, authenticate the face template without glasses further. If the face template with glasses has been registered, authenticate the face template with the previously worn glasses.
- If a part of the face template is covered with a hat, a mask, an eye patch, or sunglasses, authentication may fail. Do not cover the face template, allow the device to recognize both the eyebrows and the face template.

1.4 Standby Interface

After connecting the power supply, the following standby interface template is displayed:



- Click  icon to enter the User ID input interface template.
- When there is no Super Administrator set in the device, tap  icon to go to the menu.
- After setting the Super Administrator on the device, it requires the Super Administrator's verification before entering the menu functions.
- **Note:** For the security of the device, it is recommended to register super administrator the first time you use the device.
- On the standby interface template, the punch state options can also be shown and used directly. Click anywhere on the screen apart from the icons, and six shortcut keys appears on the screen, as shown in the figure below:



- Press the corresponding punch state key to select your current punch state, which is displayed in green.

Note: The punch state options are off by default and need to be changed to other option in the ["7.4 Punch States Options"](#) to get the punch state options on the standby screen.

1.5 Virtual Keyboard

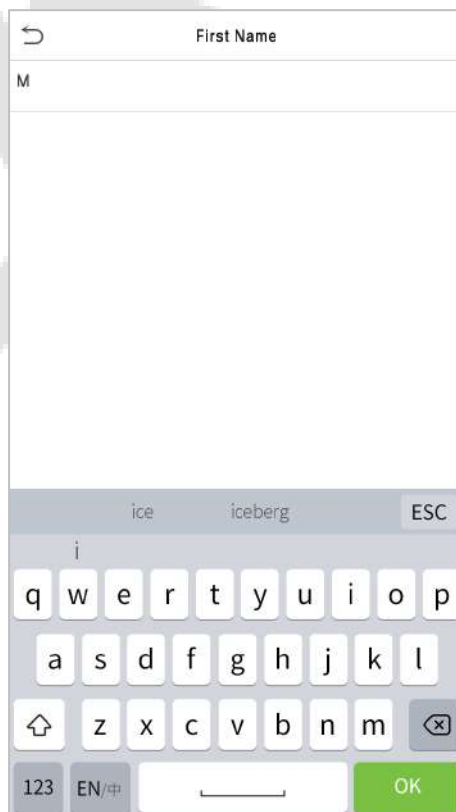

Note:

The device supports the input in Chinese language, English language, numbers, and symbols.

- Click **En** to switch to the English keyboard.
- Press **123** to switch to the numeric and symbolic keyboard.
- Click **ABC** to return to the alphabetic keyboard.
- Click the input box, virtual keyboard appears.
- Click **ESC** to exit the virtual keyboard.



1.6 Verification Mode

1.6.1 Fingerprint Verification

- **1: N Fingerprint Verification Mode**

The device compares the current fingerprint with the available fingerprint data stored in its database.

Fingerprint authentication mode is activated when a user places their finger onto the fingerprint scanner.

Please follow the recommended way to place your finger onto the sensor. For details, please refer to section [Finger Positioning](#).

Verification is successful:

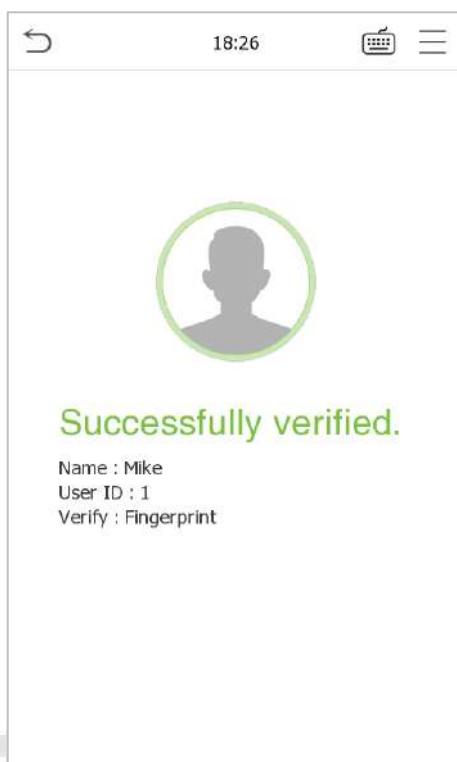

Verification is failed:

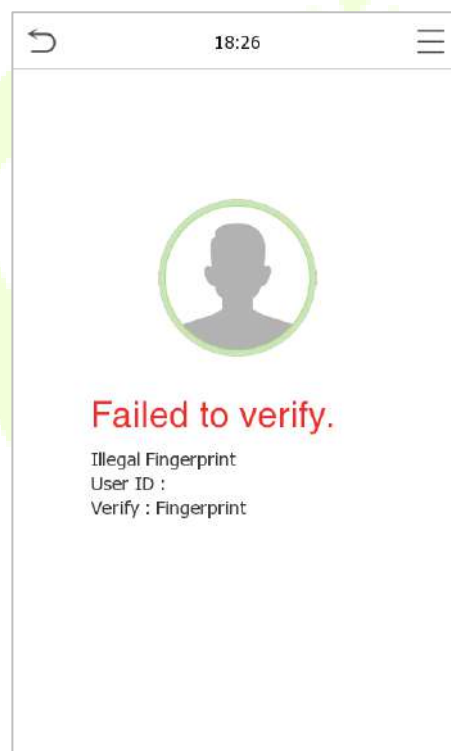

- **1: 1 Fingerprint Verification Mode**

The device compares the current fingerprint with the fingerprints linked to the entered User ID through the virtual keyboard

In case users are unable to gain access using the 1:N authentication method, they can attempt to verify their identity using the 1:1 verification mode.

Click the  button on the main screen to enter 1:1 fingerprint verification mode.

Input the user ID and press **OK**.



If the user has registered face template and password in addition to his/her fingerprints and the verification method is set to password/fingerprint/face template verification, the following screen will appear. Select the fingerprint icon to enter fingerprint verification mode.

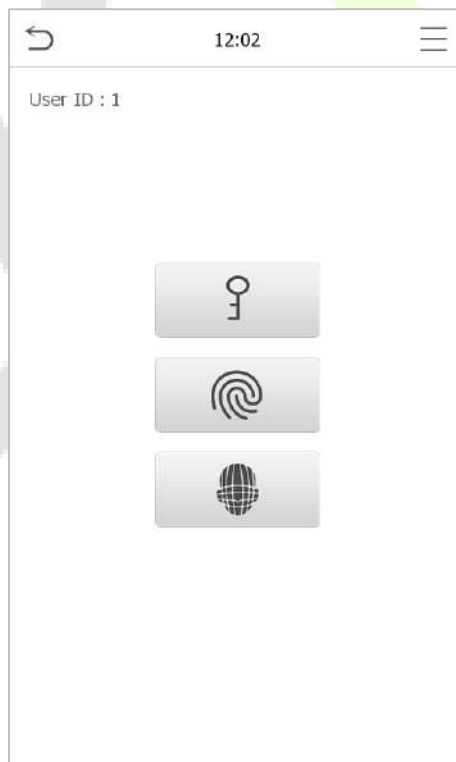

Press the fingerprint to verify.

Verification is successful:

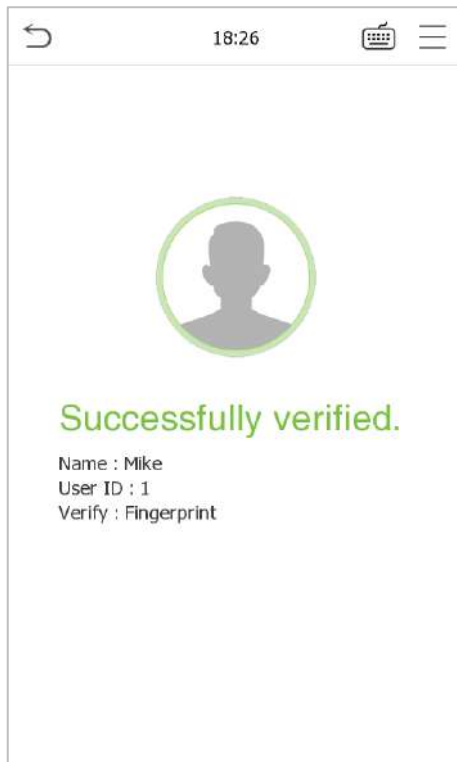

Verification is failed:

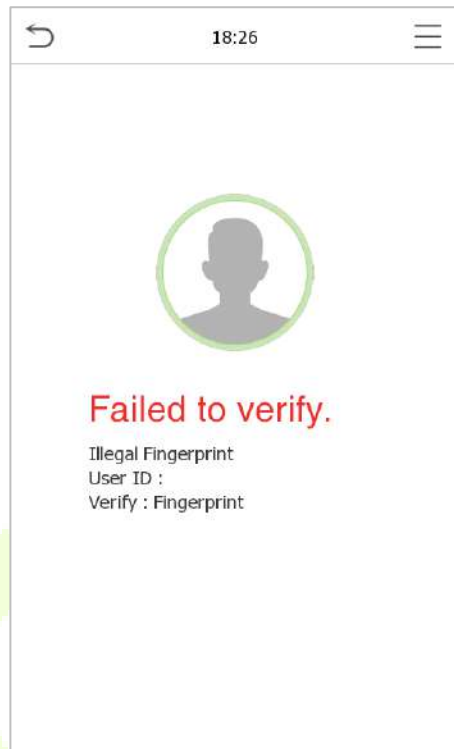

1.6.2 QR Code Verification

Note: This function is only for SpeedFace template-V4L Pro [QR].

In this verification mode, the device compares the QR code image collected by the QR code collector with all the QR code data in the device.

Tap **Mobile Credential** on the ZKBioAccess Mobile Page, and a QR code will appear, which includes employee ID and card number (static QR code only includes card number) information. The QR code can replace a physical card on a specific device to achieve contactless authentication. Please refer to [17.4 Mobile Credential](#).



1.6.3 Card Verification★

Card verification can be set up as both card and QR code verification methods.

- **1:N card verification**

The 1:N card verification mode compares the card number in the card induction area with all the card number data registered in the device; The following screen displays on the card verification:

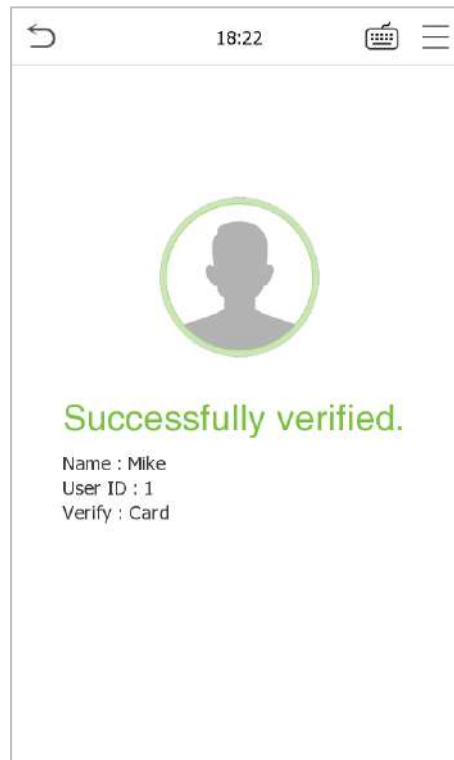

- **1:1 card verification**

The 1:1 card verification mode compares the card number in the card induction area with the number associated with the employee's User ID registered in the device.

Press  in the main interface template to open the 1:1 card verification mode.

Enter the user ID and click **OK**.



If the user has registered face template, card and password in addition to his/her card, and the verification method is set to fingerprint/card/password verification, the following screen will appear. Select the  icon to enter the card verification mode.



After successful verification, the prompt box displays "**Successfully Verified**", as shown below:

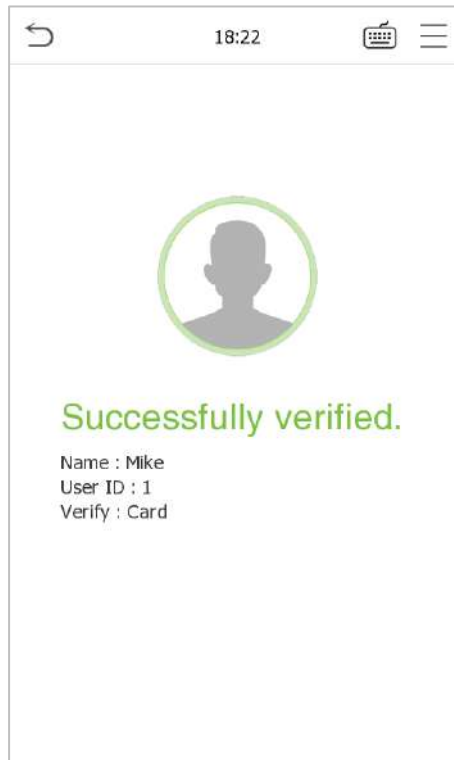

1.6.4 Facial Verification

- **1:N Facial Verification**

device compares the currently acquired facial images with all the registered face template data stored in its database. The following is the pop-up prompt box displaying the result of the comparison.



● 1:1 Facial Verification

In this verification mode, the device compares the face template captured by the camera with the facial template related to the entered user ID. Press icon  in the main interface template and enter the 1:1 facial verification mode and enter the user ID and click **OK**.



If the user has registered card and password in addition to his/her face template, and the verification method is set to face template/fingerprint/password verification, the following screen will appear.

Select the  icon to enter the face template verification mode.



After successful verification, the prompt box displays "**Successfully Verified**", as shown below:



If the verification is failed, it prompts "**Please adjust your position!**".

1.6.5 Password Verification

The device compares the entered password with the registered password by the given User ID.

Click the  button on the main screen to enter the 1:1 password verification mode. Then, input the user ID and press **OK**.



If the user has registered face template and card in addition to password, and the verification method is set to face template/fingerprint/password verification, the following screen will appear. Select the  icon to enter password verification mode.



Input the password and press **OK**.



The following screen displays, after inputting a correct password and a wrong password respectively.

Verification is successful:

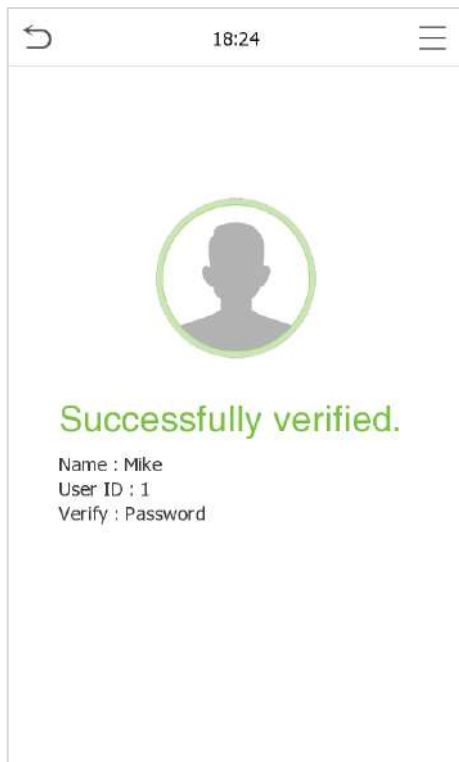

Verification is failed:

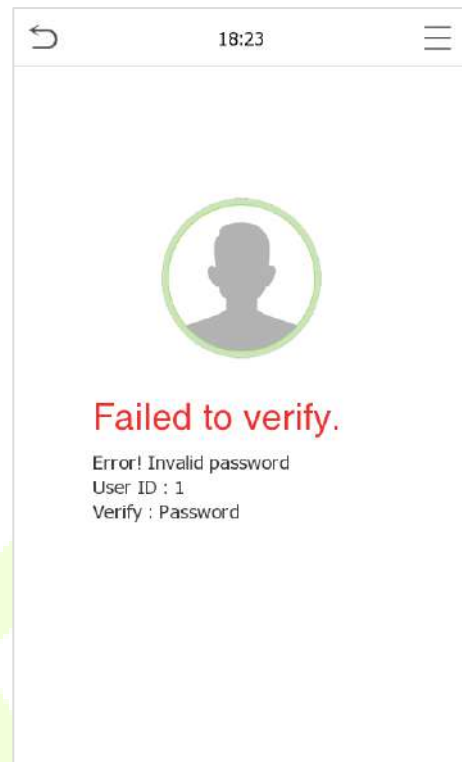

1.6.6 Combined Verification

To increase security, this device offers the option of using multiple forms of verification methods. A total of 12 different verification combinations can be used, as shown below:

Combined Verification Symbol Definition:

Symbol	Definition	Explanation
/	or	This method compares the entered verification of a person with the related verification template previously stored to that Personnel ID in the Device.
+	and	This method compares the entered verification of a person with all the verification template previously stored to that Personnel ID in the Device.

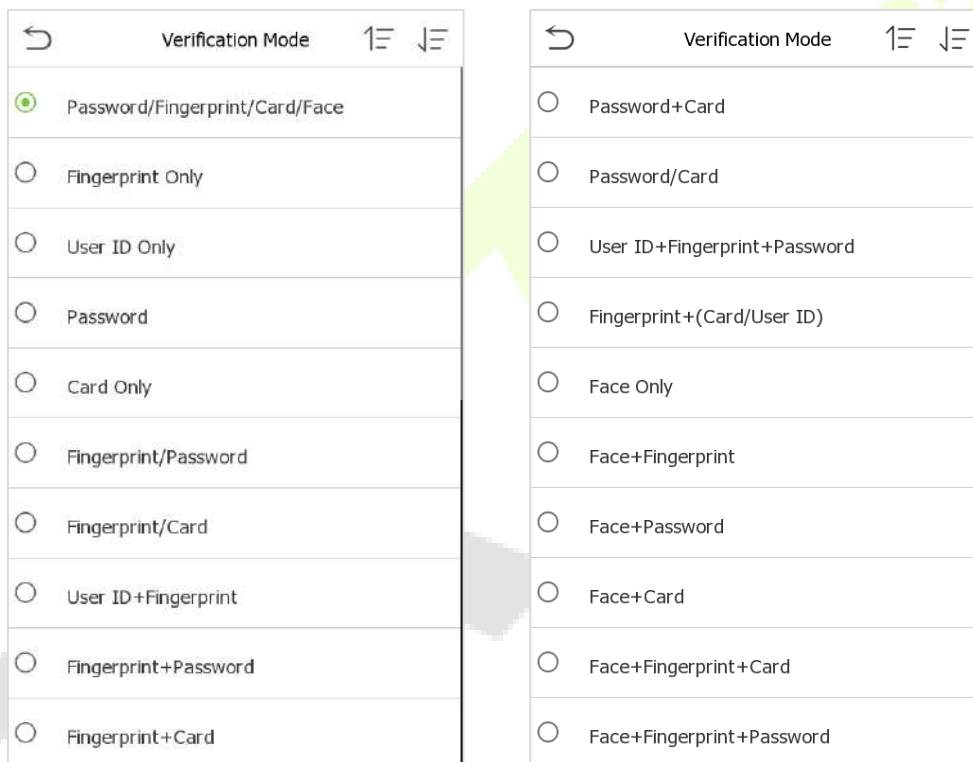

Procedure to set for Combined Verification Mode:

- Combined verification requires personnel to register all the different verification method. Otherwise, employees will not be able to successfully verify the combined verification process.
- For instance, when an employee has registered only the data, but the Device verification mode is set as “Face + Password”, the employee will not be able to complete the verification process successfully.
- This is because the Device compares the scanned face template template of the person with registered verification template (both the Face template and the Password) previously stored to that Personnel ID in the Device.
- But as the employee has registered only the Face template but not the Password, the verification will not get completed and the Device displays “Verification Failed”.

2 Main Menu

Press  on the Standby interface to enter the **Main Menu**, the following screen will be displayed:

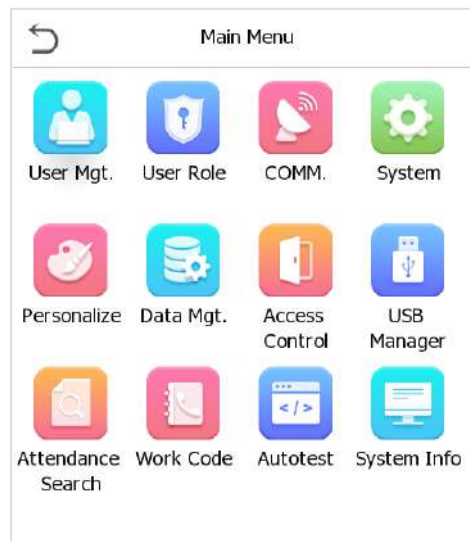

Function Description

Menu	Descriptions
User Mgt.	To add, edit, view, and delete basic information of a User.
User Role	To set the permission scope of the custom role and enroller for the users, that is, the rights to operate the system.
COMM.	To set the relevant parameters of network, serial comm, pc connection, wireless network, cloud server, wiegand and network diagnosis.
System	To set the parameters related to the system, including date time, access logs setting, face template & fingerprint parameters, video intercom parameters, security setting, reset to factory, USB upgrade, and device type setting.
Personalize	This includes user interface, voice, bell schedules, punch state options and shortcut key mappings settings.
Data Mgt.	To delete all relevant data in the device.
Access Control	To set the parameters of the lock and the relevant access control device including options like time rule, holiday settings, combine verification, anti-passback setup, and duress option settings.
USB Manager	To upload or download the specific data by a USB drive.
Attendance Search	To query the specified event logs, check attendance photos and blacklist attendance photos.
Work Code★	Set different type of work.
Autotest	To automatically test whether each module functions properly, including the LCD screen, audio, microphone, camera, fingerprint sensor and real-time clock.

System Info	To view data capacity, device and firmware information and privacy policy of the device.
--------------------	------------------------------------------------------------------------------------------

Note: When users use the product for the first time, they should operate it after setting administrator privileges. Tap **User Mgt.** to add an administrator or edit user permissions as a super administrator. If the product does not have an administrator setting, the system will show an administrator setting command prompt every time you enter the device menu.



3 User Management

3.1 User Registration

Click **User Mgt.** on the main menu.

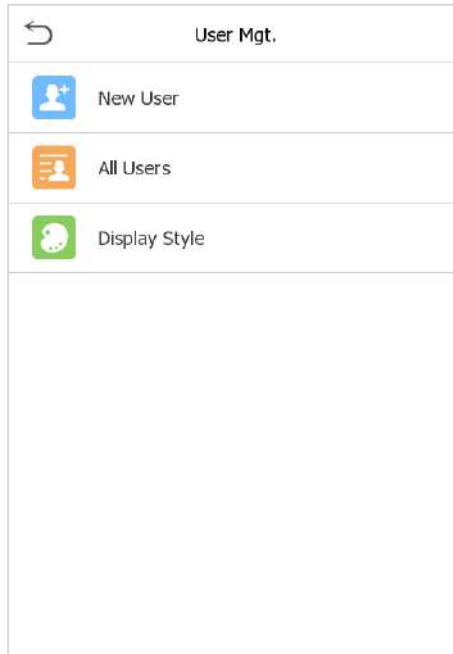

3.1.1 User ID and Name

Tap **New User.** Enter the **User ID** and **Name.**

A screenshot of a mobile application form titled "New User". The form has a back arrow icon on the left and the title "New User" on the right. It contains several input fields with labels and values: "User ID" with value "2", "Name" (empty), "User Role" with value "Normal User", "Fingerprint" with value "0", "Face" with value "0", "Card" with value "0", "Password" (empty), "Profile Photo" with value "0", and "Access Control Role" (empty). There is an additional empty field at the bottom.

Notes:

- A username can contain a maximum of 34 characters.
- The user ID may contain 1 to 14 digits by default.
- During the initial registration, you can modify your ID, which cannot be modified after registration.
- If a message "**Duplicated!**" pops up, you must choose another ID as the enter User ID already exists.

3.1.2 User Role

On the New User interface, tap on **User Role** to set the role for the user as either **Normal User** or **Super Admin**.

- **Super Admin:** The Super Administrator owns all management privileges in the Device.
- **Normal User:** If the Super Admin is already registered in the Device, then the Normal Users will not have the privileges to manage the system and can only access authentication verifications.
- **User Defined Roles:** The Normal User can also be set with **User Defined Role** which are the custom roles that can be set to the Normal User.

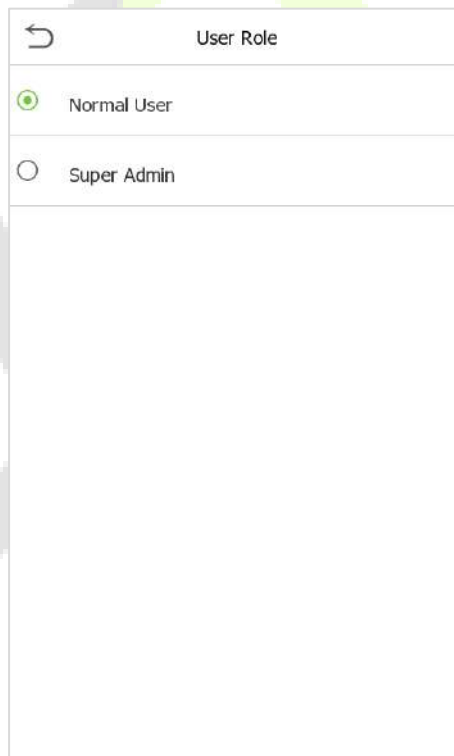

Note: If the selected user role is the Super Admin, the user must pass the identity authentication to access the main menu. The authentication is based on the authentication method(s) that the super administrator has registered. Please refer to [1.5 Verification Mode](#).

3.1.3 Fingerprint

Click **Fingerprint** to enter the fingerprint registration page. Select the finger to be enrolled.

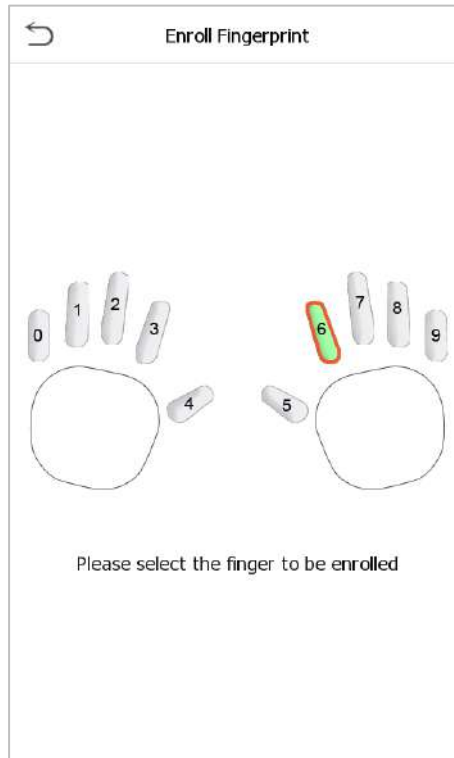

Press the same finger on the fingerprint reader three times. Green indicates that the fingerprint was enrolled successfully.

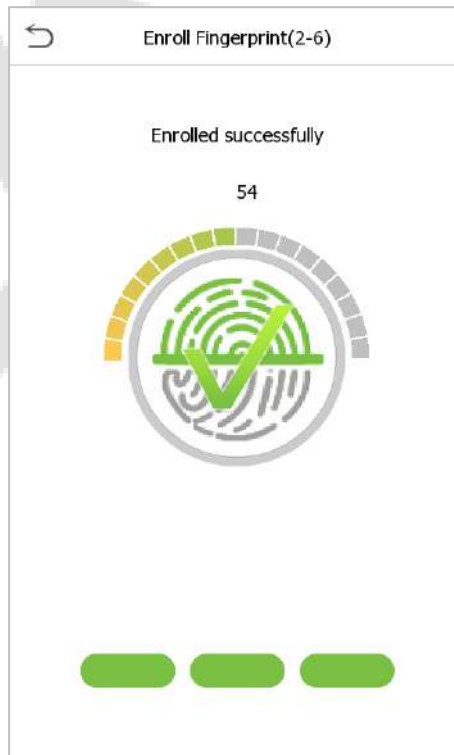

3.1.4 Face Template

Tap **Face** in the **New User** interface to enter the face template registration page.

- Please face towards the camera and position your face template inside the white guiding box and stay still during face template registration.
- A progress bar shows up while registering the face template and a **“Enrolled Successfully”** is displayed as the progress bar completes.
- If the face template is registered already then, the **“Duplicate Face”** message shows up. The registration interface is as follows:



3.1.5 Card★

Tap **Card** in the **New User** interface to enter the card registration page.

- On the Card interface, swiping card underneath the card reading area. The card registration will be successful.
- If the card is registered already then, the **"Duplicate Card"** message shows up. The registration interface is as follows:

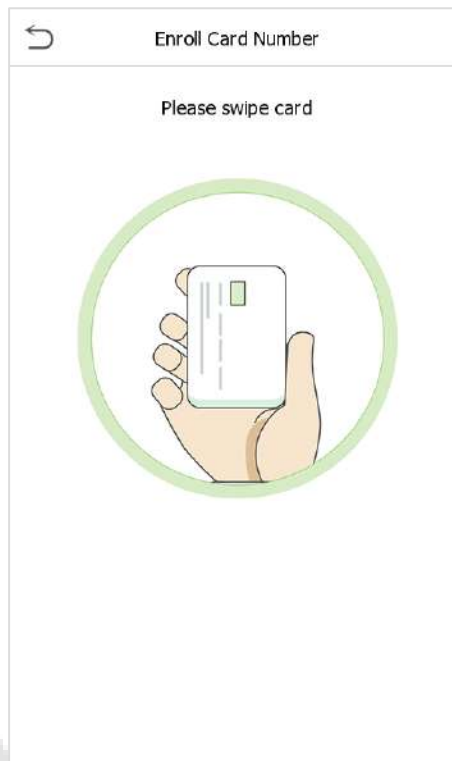

3.1.6 Password

Tap **Password** in the **New User** interface to enter the password registration page.

- On the Password interface, enter the required password and re-enter to confirm it and tap **OK**.
- If the re-entered password is different from the initially entered password, then the device prompts the message as **"Password not match!"**, where the user needs to re-confirm the password again.

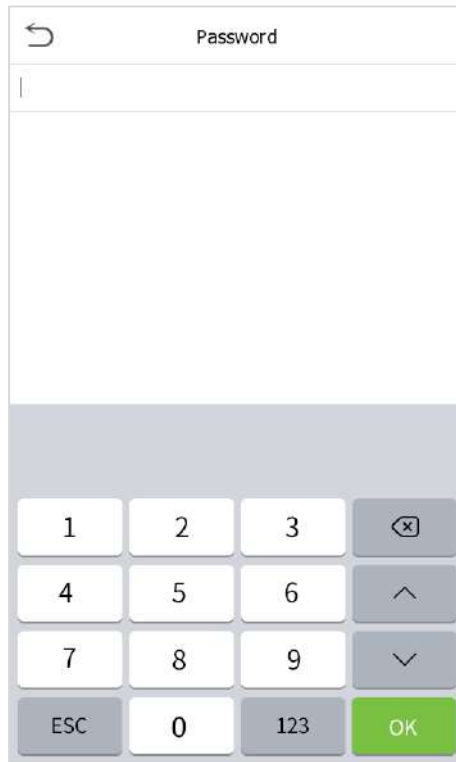

Note: The password may contain 6 to 8 digits by default.

3.1.7 Profile Photo

Tap on **Profile Photo** in the **New User** interface to go to the Profile Photo registration page.

New User	
User ID	2
Name	
User Role	Normal User
Fingerprint	0
Face	0
Card	0
Password	
Profile Photo	0
Access Control Role	



- When a user registered with a photo passes the authentication, the registered photo will be displayed.
- Tap **Profile Photo**, the device’s camera will open, then tap the camera icon to take a photo. The captured photo is displayed on the top left corner of the screen and the camera opens again to take a new photo, after taking the initial photo.

Note: While registering a face template, the system automatically captures a photo as the user profile photo. If you do not register a profile photo, the system automatically sets the photo captured while registration as the default photo.

3.1.8 Access Control Role

The **Access Control Role** sets the door access privilege for each user. This includes the access group, duress fingerprint and facilitates to set the group access time-period.

- Tap **Access Control Role > Access Group**, to assign the registered users to different groups for better management. New users belong to Group 1 by default and can be reassigned to other groups. The device supports up to 99 Access Control groups.
- Tap **Time Period**, to select the time period to use.

Access Control	
Access Group	Disabled
Time Period	
Duress Fingerprint	Undefined

3.2 Search for Users

On the **Main Menu**, tap **User Mgt.**, and then tap **All Users** to search for a User.

- On the **All Users** interface, tap on the search bar on the user’s list to enter the required retrieval keyword (where the keyword may be the user ID, surname or full name) and the system will search for the related user information.

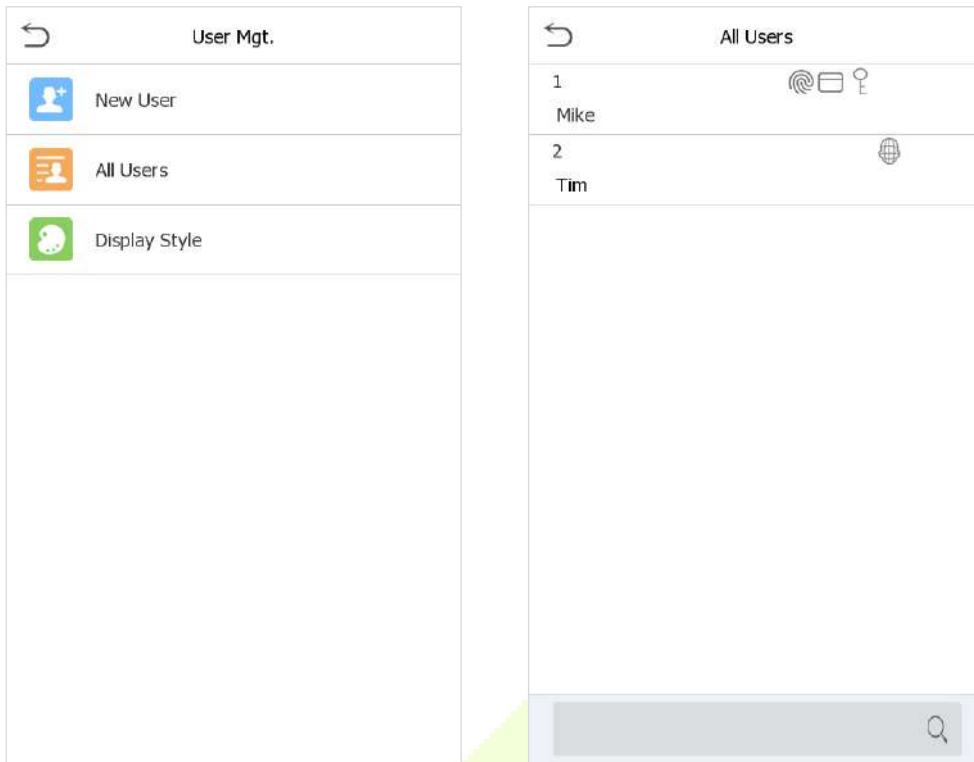

3.3 Edit User

On **All Users** interface, tap on the required user from the list and tap **Edit** to edit the user information.

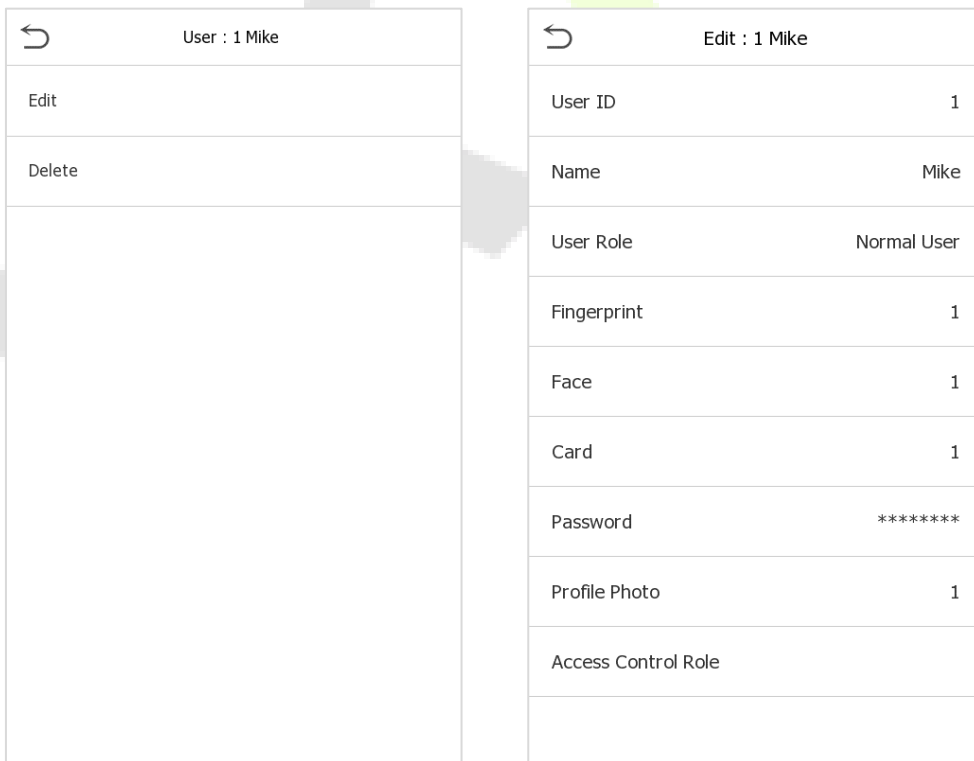

Note: The process of editing a user is the same as that of adding a user, except that the user ID cannot be modified when editing a user’s detail. The process in detail refers to "[3. User Management](#)".

3.4 Delete User

On **All Users** interface, tap on the required user from the list and tap **Delete** to delete the user or a specific user information from the device. On the **Delete** interface, tap on the required operation and then tap OK to confirm the deletion.

- **Delete operations:**

Delete User: All information of the user will be deleted (deletes the selected User as a whole) from the Device.

Delete Fingerprint Only: Deletes the fingerprint information of the selected user.

Delete Face Only: Deletes the face template information of the selected user.

Delete Password Only: Deletes the password information of the selected user.

Delete Card Number Only: Deletes the card information of the selected user.

Delete Profile Photo Only: Deletes the profile photo of the selected user.

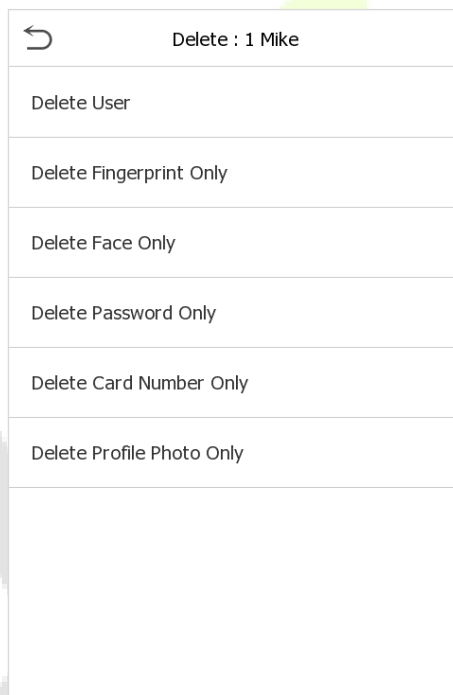

3.5 Display Style

Tap on **User Mgt.** > **Display Style** to choose the style of **All Users** interface's list.



Different display styles are shown as below:

Multiple Line:

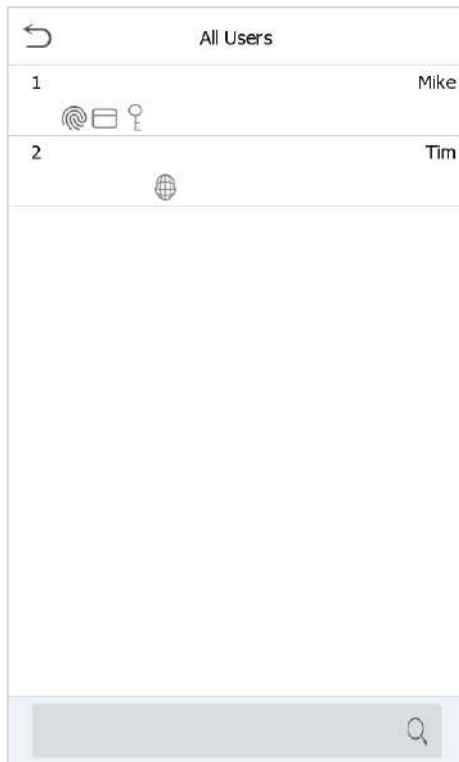

Mixed Line:

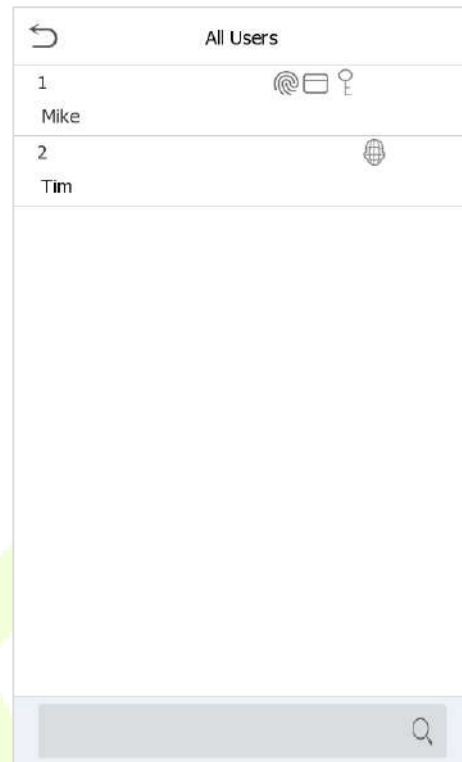

4 User Role

User Role facilitates to assign some specific permissions to specific users, based on the requirement.

- On the **Main** menu, tap **User Role**, and then tap on the **User Defined Role** to set the user defined permissions.
- The permission scope of the custom role can be set up to 3 roles, that is, the custom operating scope of the menu functions of the user.

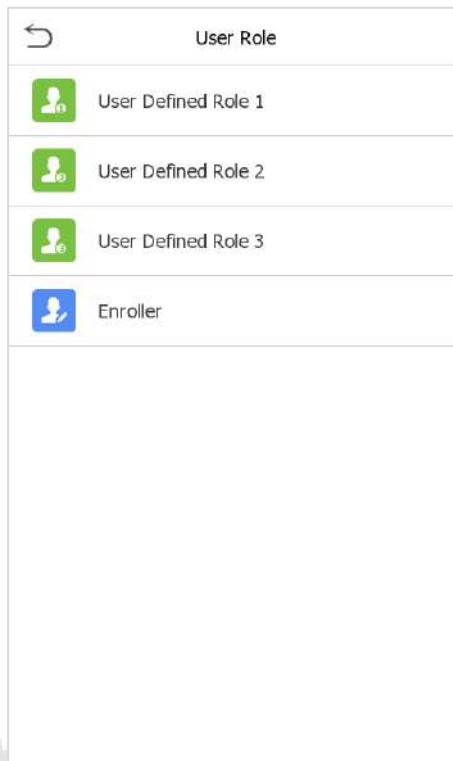

- On the **User Defined Role** interface, toggle **Enable Defined Role** to enable or disable the user defined role.
- Tap on **Name** and enter the custom name of the role.

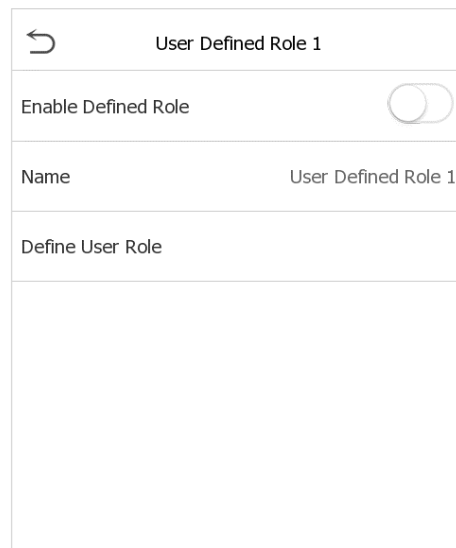
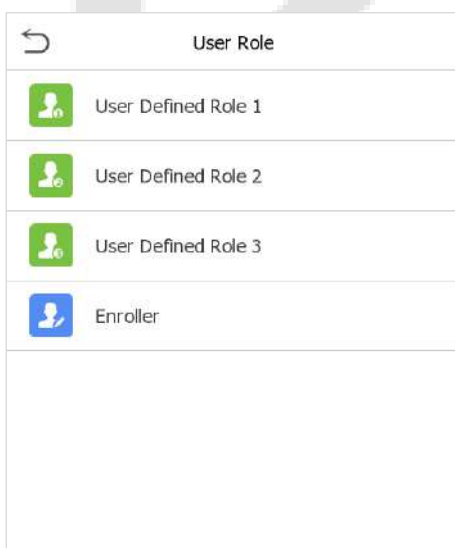

- Then, tap on **User Defined Role** and select the required privileges to assign to the new role, and then tap on the **Return** button.
- During privilege assignment, the main menu function names will be displayed on the left and its sub-menus will be listed on its right.
- First tap on the required **Main Menu** function name, and then select its required sub-menus from the list.

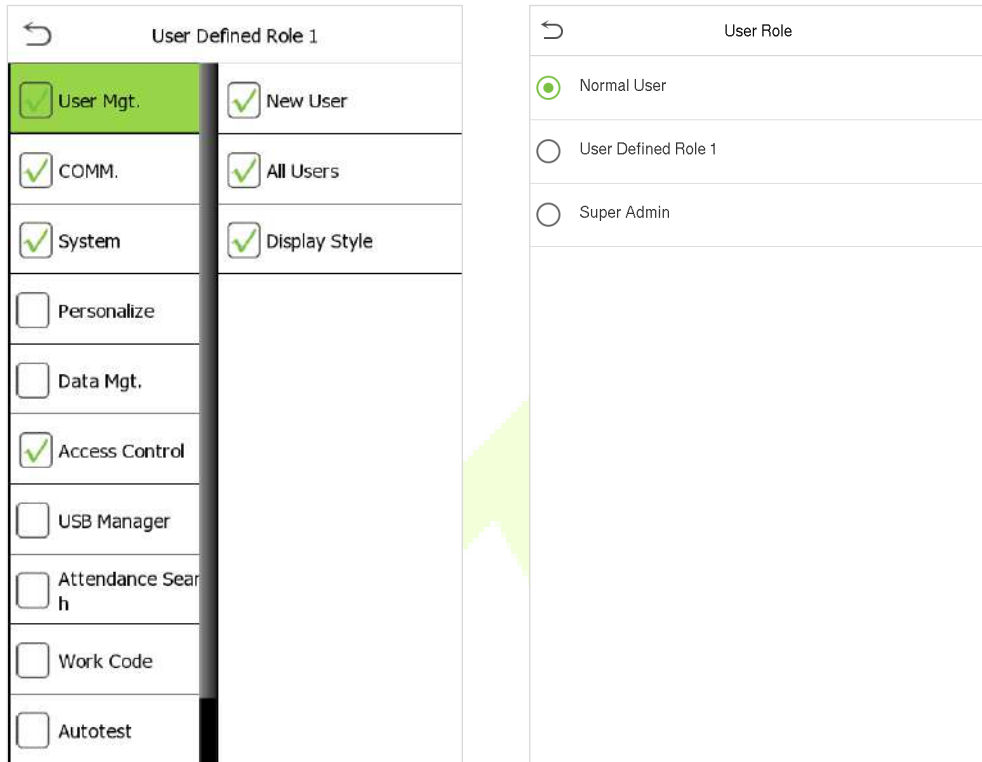

Note: If the User Role is enabled for the Device, tap on **User Mgt. > New User > User Role** to assign the created roles to the required users. But if there is no super administrator registered in the Device, then the device will prompt "Please enroll super admin first!" when enabling the User Role function.

5 Communication Settings

Tap **COMM.** on the **Main Menu** to set the relevant parameters of Network, Serial Comm, PC Connection, Wireless Network, Cloud Server, Wiegand and Network Diagnosis.

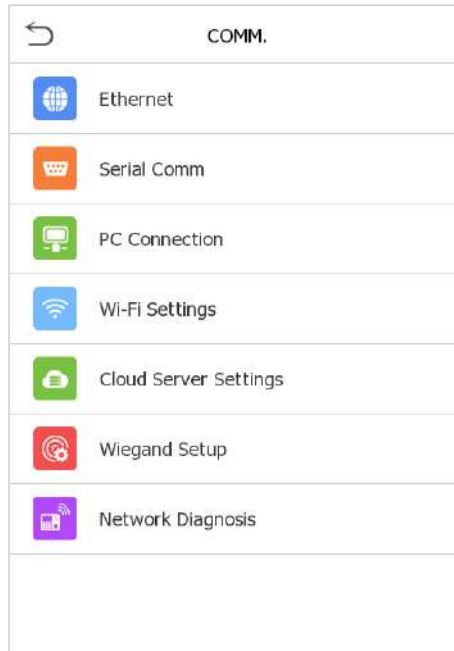

5.1 Network Settings

When the device needs to communicate with a PC over the Ethernet, you need to configure network settings and ensure that the device and the PC are connecting to the same network segment.

Tap **Ethernet** on the **Comm.** Settings interface to configure the settings.

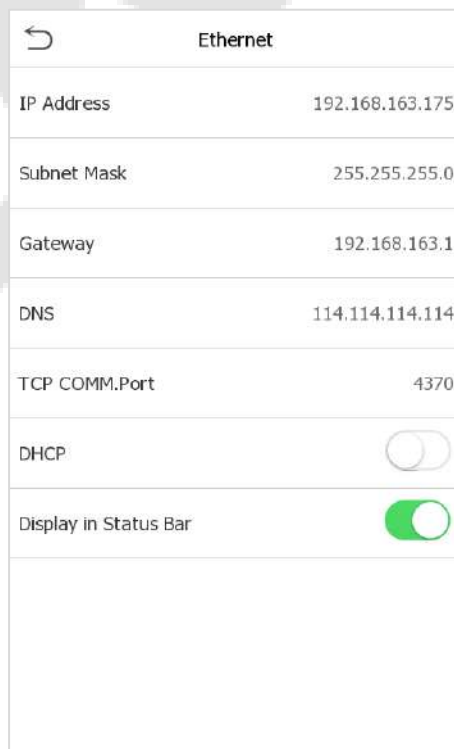

Function Description

Function Name	Descriptions
IP Address	The default IP address is 192.168.1.201. It can be modified according to the network availability.
Subnet Mask	The default Subnet Mask is 255.255.255.0. It can be modified according to the network availability.
Gateway	The default Gateway address is 0.0.0.0. It can be modified according to the network availability.
DNS	The default DNS address is 0.0.0.0. It can be modified according to the network availability.
TCP COMM. Port	The default TCP COMM Port value is 4370. It can be modified according to the network availability.
DHCP	Dynamic Host Configuration Protocol is to dynamically allocate IP addresses for clients via server.
Display in Status Bar	Toggle to set whether to display the network icon on the status bar.

5.2 Serial Comm

Serial Comm function facilitates to establish communication with the device through a serial port (RS485/ Master Unit).

Tap **Serial Comm.** on the **Comm.** Settings interface.

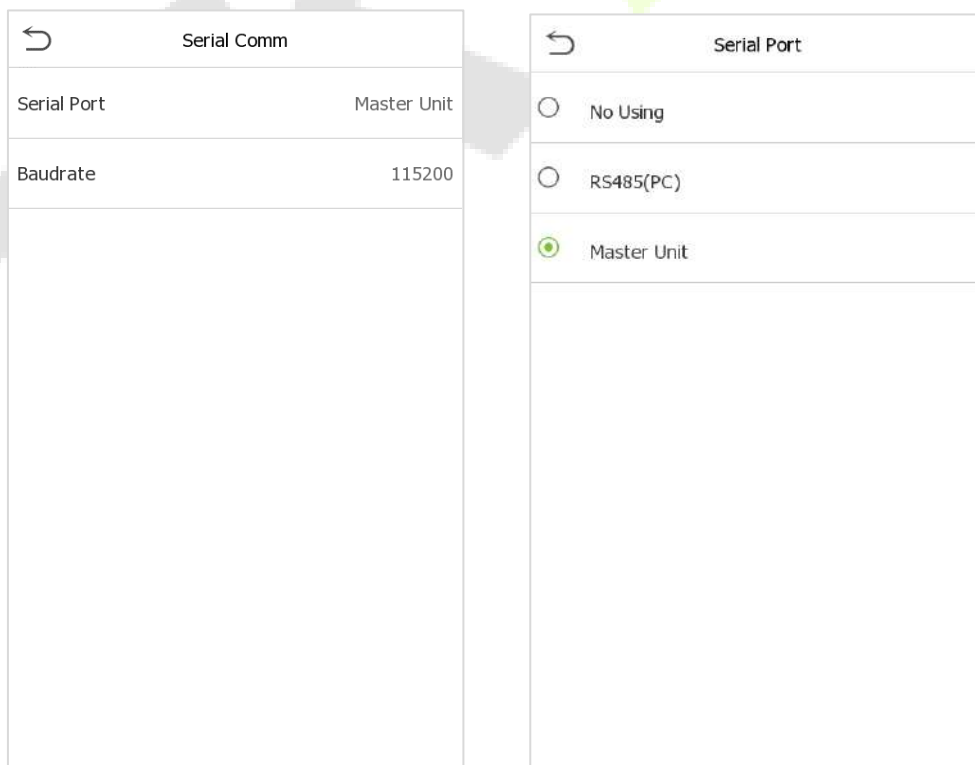

Function Description

Function Name	Descriptions
Serial Port	<p>no using: Do not communicate with the device through the serial port.</p> <p>RS485(PC): Communicates with the device through RS485 serial port.</p> <p>Master Unit: When RS485 is used as the function of “Master unit”, the device will act as a master unit, and it can be connected to RS485 card reader.</p>
Baud Rate	<p>The rate at which the data is communicated with PC, there are 4 options of baud rate: 115200 (default), 57600, 38400, and 19200.</p> <p>The higher is the baud rate, the faster is the communication speed, but also the less reliable.</p> <p>Hence, a higher baud rate can be used when the communication distance is short; when the communication distance is long, choosing a lower baud rate would be more reliable.</p>

5.3 PC Connection

To improve the security of data, please set a Comm Key for communication between the device and the PC. The connection password needs to be entered before the device can be connected to the PC software if a Comm Key is set.

Tap **PC Connection** on the **Comm.** Settings interface to configure the communication settings.

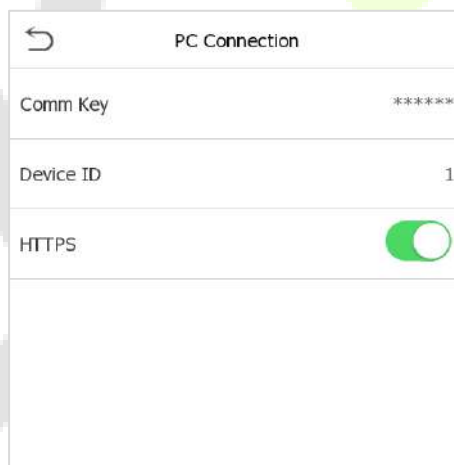

Function Description

Function Name	Descriptions
Comm Key	<p>The default password is 0 and can be changed.</p> <p>The Comm Key must be 6 digits.</p>
Device ID	<p>Identity number of the device, which ranges between 1 and 254.</p> <p>If the communication method is RS232/RS485, you need to input this device ID in the software communication interface.</p>

HTTPS

To increase the security of software access, users can enable the HTTPS protocol to create a secure and encrypted network transmission and assure the security of sent data through identity authentication and encrypted communication.

This function is enabled by default. This function can be enabled or disabled through the menu interface, and when changing the HTTPS status, the device will pop up a security prompt, and restart after confirmation.

5.4 Wireless Network★

The device provides a Wi-Fi module, which can be built-in within the device mould or can be externally connected.

The Wi-Fi module enables data transmission via Wi-Fi (Wireless Fidelity) and establishes a wireless network environment. Wi-Fi is enabled by default in the device. If you don't need to use the Wi-Fi network, you can toggle the Wi-Fi to disable button.

Tap **Wireless Network** on the **Comm.** Settings interface to configure the WiFi settings.

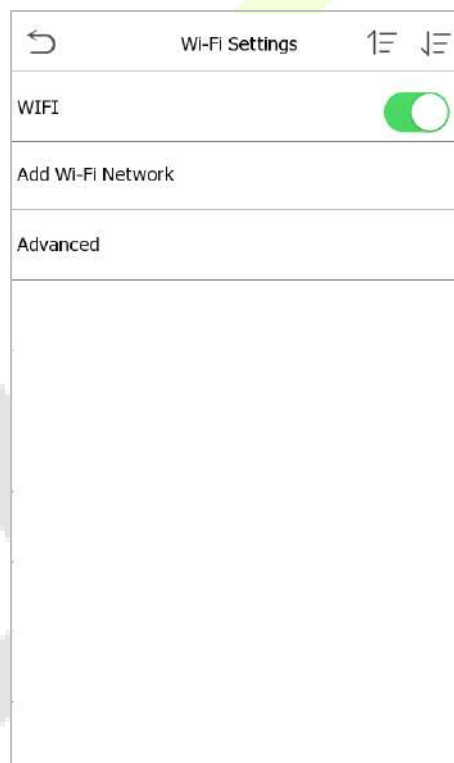

- **Search the WIFI Network**

- WIFI is enabled in the Device by default. Toggle on  button to enable or disable WIFI.
- Once the Wi-Fi is turned on, the device will search for the available WIFI within the network range.
- Choose the appropriate WiFi name from the available list, and input the correct password in the password interface, and then tap **Connect to WIFI (OK)**.

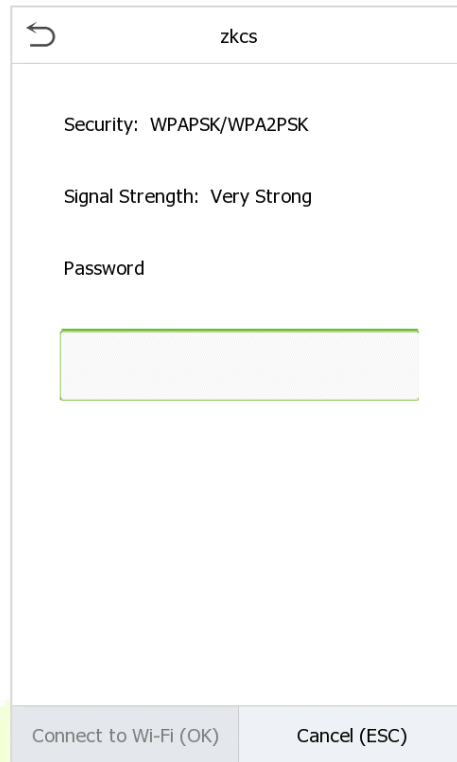
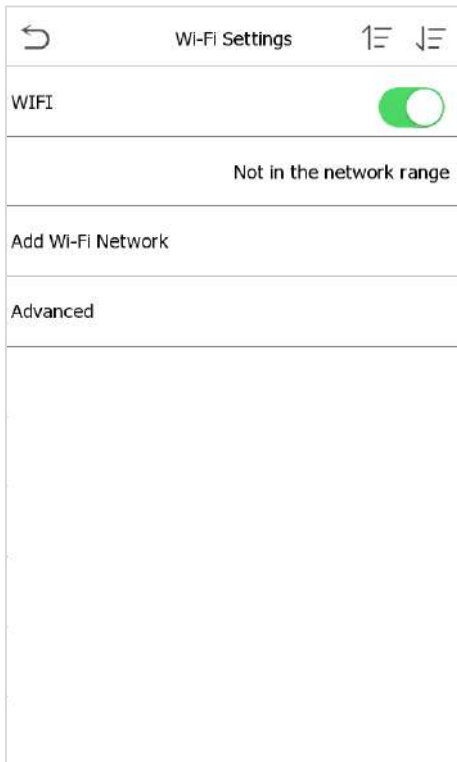

WIFI Enabled: Tap on the required network from the searched network list.

Tap on the password field to enter the password, and then tap on **Connect to WIFI (OK)**.

- When the WIFI is connected successfully, the initial interface will display the Wi-Fi  logo.
- **Add WIFI Network Manually**

The Wi-Fi can also be added manually if the required Wi-Fi does not show on the list.

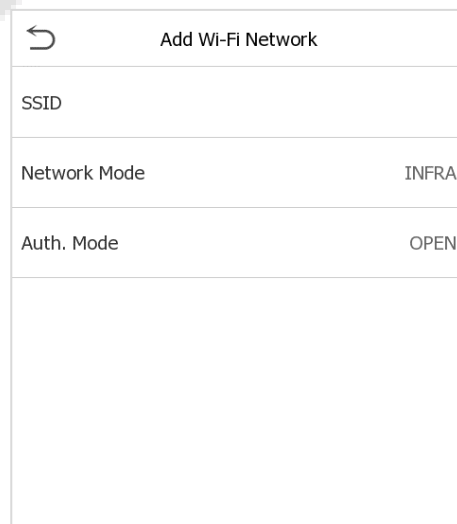
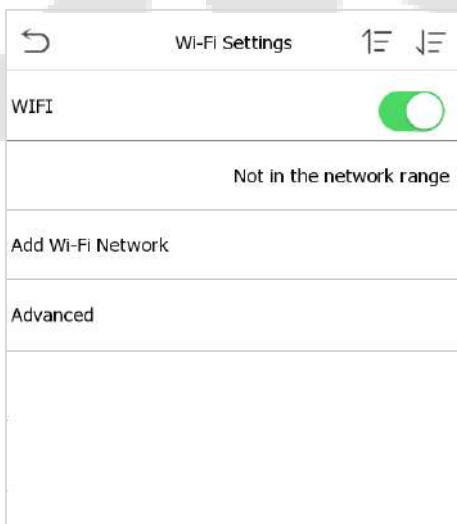

Tap on **Add WIFI Network** to add the WIFI manually.

On this interface template, enter the WIFI network parameters. (The added network must exist.)

Note: After successfully adding the WIFI manually, follow the same process to search for the added WIFI name. Click here to view the process to search the WIFI network.

● **Advanced Setting**

On the **Wireless Network** interface, tap on **Advanced** to set the relevant parameters as required.

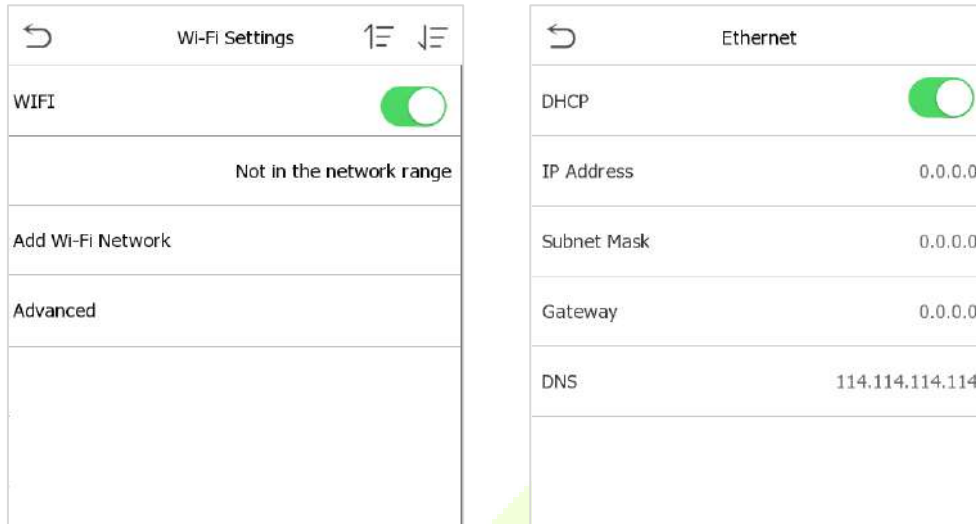

Function Description

Function Name	Description
DHCP	Dynamic Host Configuration Protocol (DHCP) dynamically allocates IP addresses to network clients. If the DHCP is enabled, then the IP cannot be set manually.
IP Address	IP address for the WIFI network, the default is 0.0.0.0. It can be modified according to the network availability.
Subnet Mask	The default Subnet Mask of the WIFI network is 255.255.255.0. It can be modified according to the network availability.
Gateway	The default Gateway address is 0.0.0.0. Can be modified according to the network availability.
DNS	The default DNS address is 0.0.0.0. It can be modified according to the network availability.

5.5 Cloud Server Setting

Tap **Cloud Server Setting** on the **Comm.** Settings interface to connect with the ADMS server.

Cloud Server Settings	
Server Mode	ADMS
Enable Domain Name	<input type="checkbox"/>
Server Address	192.168.1.220
Server Port	8088
Enable Proxy Server	<input type="checkbox"/>

Function Description

Function Name		Description
Enable Domain Name	Server Address	Once this function is enabled, the domain name mode "http://..." will be used, such as http://www.XYZ.com, while "XYZ" denotes the domain name (when this mode is turned ON).
Disable Domain Name	Server Address	IP address of the ADMS server.
	Server Port	Port used by the ADMS server.
Enable Proxy Server		When you choose to enable the proxy, you need to set the IP address and port number of the proxy server.

5.6 Wiegand Setup

To set the Wiegand input and output parameters.

Tap **Wiegand Setup** on the **Comm.** Settings interface to set the Wiegand input and output parameters.

Wiegand Setup	
Wiegand Input	
Wiegand Output	

5.6.1 Wiegand Input

Wiegand Options	
Wiegand Format	
Wiegand Bits	64
Pulse Width(us)	100
Pulse Interval(us)	1000
ID Type	Card Number

Function Description

Function Name	Descriptions
Wiegand Format	Values range from 26 Bits, 32 Bits, 34 Bits, 36 Bits, 37 Bits, 50 Bits and 64Bits.
Wiegand Bits	Number of bits of Wiegand data.
Pulse Width(us)	The value of the pulse width sent by Wiegand is 100 microseconds by default, which can be adjusted within the range of 20 to 400 microseconds.
Pulse Interval(us)	The default value is 1000 microseconds, which can be adjusted within the range of 200 to 20000 microseconds.
ID Type	Select between User ID and card number.

Various Common Wiegand Format Description

Wiegand Format	Description
Wiegand26	ECCCCCCCCCCCCCCCCCCCCCCCCCO Consists of 26 bits of binary code. The 1 st bit is the even parity bit of the 2 nd to 13 th bits, while the 26 th bit is the odd parity bit of the 14 th to 25 th bits. The 2 nd to 25 th bits is the card numbers.
Wiegand26a	ESSSSSSSSCCCCCCCCCCCCCCCCCO Consists of 26 bits of binary code. The 1 st bit is the even parity bit of the 2 nd to 13 th bits, while the 26 th bit is the odd parity bit of the 14 th to 25 th bits. The 2 nd to 9 th bits is the site codes, while the 10 th to 25 th bits are the card numbers.
Wiegand34	ECCCCCCCCCCCCCCCCCCCCCCCCCCCCCO Consists of 34 bits of binary code. The 1 st bit is the even parity bit of the 2 nd to 17 th bits, while the 34 th bit is the odd parity bit of the 18 th to 33 rd bits. The 2 nd to 25 th bits is the card numbers.

Wiegand34a	<p>ESSSSSSSSCCCCCCCCCCCCCCCCCCCCCCCCCO</p> <p>Consists of 34 bits of binary code. The 1st bit is the even parity bit of the 2nd to 17th bits, while the 34th bit is the odd parity bit of the 18th to 33rd bits. The 2nd to 9th bits is the site codes, while the 10th to 25th bits are the card numbers.</p>
Wiegand36	<p>OFFFFFFFFFCCCCCCCCCCCCCCCCMME</p> <p>Consists of 36 bits of binary code. The 1st bit is the odd parity bit of the 2nd to 18th bits, while the 36th bit is the even parity bit of the 19th to 35th bits. The 2nd to 17th bits is the device codes. The 18th to 33rd bits is the card numbers, and the 34th to 35th bits are the manufacturer codes.</p>
Wiegand36a	<p>EFFFFFFFFFCCCCCCCCCCCCCCCCCO</p> <p>Consists of 36 bits of binary code. The 1st bit is the even parity bit of the 2nd to 18th bits, while the 36th bit is the odd parity bit of the 19th to 35th bits. The 2nd to 19th bits is the device codes, and the 20th to 35th bits are the card numbers.</p>
Wiegand37	<p>OMMMMSSSSSSSSSSSSCCCCCCCCCCCCCCCCCE</p> <p>Consists of 37 bits of binary code. The 1st bit is the odd parity bit of the 2nd to 18th bits, while the 37th bit is the even parity bit of the 19th to 36th bits. The 2nd to 4th bits is the manufacturer codes. The 5th to 16th bits is the site codes, and the 21st to 36th bits are the card numbers.</p>
Wiegand37a	<p>EMMMFFFFFFFSSSSSSCCCCCCCCCCCCCCCCCO</p> <p>Consists of 37 bits of binary code. The 1st bit is the even parity bit of the 2nd to 18th bits, while the 37th bit is the odd parity bit of the 19th to 36th bits. The 2nd to 4th bits is the manufacturer codes. The 5th to 14th bits is the device codes, and 15th to 20th bits are the site codes, and the 21st to 36th bits are the card numbers.</p>
Wiegand50	<p>ESSSSSSSSSSSSSSSSSSSSCCCCCCCCCCCCCCCCCCCCCCCCCCCCCCCCCO</p> <p>Consists of 50 bits of binary code. The 1st bit is the even parity bit of the 2nd to 25th bits, while the 50th bit is the odd parity bit of the 26th to 49th bits. The 2nd to 17th bits is the site codes, and the 18th to 49th bits are the card numbers.</p>
<p>“C” denotes the card number; “E” denotes the even parity bit; “O” denotes the odd parity bit; “F” denotes the facility code; “M” denotes the manufacturer code; “P” denotes the parity bit; and “S” denotes the site code.</p>	

5.6.2 Wiegand Output

Wiegand Options	
SRB	<input type="checkbox"/>
Wiegand Format	
Wiegand Output Bits	32
Failed ID	Disabled
Site Code	Disabled
Pulse Width(us)	400
Pulse Interval(us)	2000
ID Type	User ID

Function Description

Function Name	Descriptions
SRB★	When SRB is enabled, the lock is controlled by the SRB to prevent the lock from being opened due to device removal.
Wiegand Format	Values range from 26 bits, 32 Bits, 34 bits, 36 bits, 37 bits, and 50 bits.
Wiegand Output Bits	After selecting the required Wiegand format, select the corresponding output bit digits of the Wiegand format.
Failed ID	If the verification is failed, the system will send the failed ID to the device and replace the card number or personnel ID with the new one.
Site Code	It is similar to the device ID. The difference is that a site code can be set manually, and is repeatable in a different device. The valid value ranges from 0 to 256 by default.
Pulse Width(us)	The time width represents the changes of the quantity of electric charge with regular high-frequency capacitance within a specified time.
Pulse Interval(us)	The time interval between pulses.
ID Type	Select the ID types as either User ID or card number.

5.7 Network Diagnosis

To set the network diagnosis parameters.

Tap **Network Diagnosis** on the **Comm.** Settings interface to set the IP address diagnostic and start the diagnostic parameters.

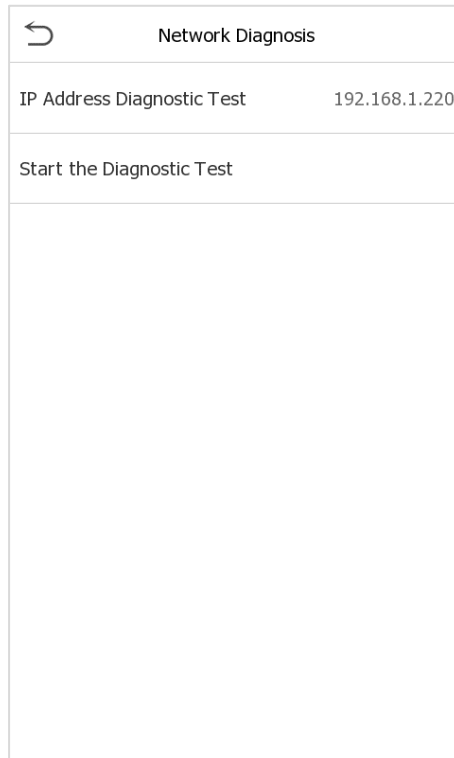

Network Diagnosis	
IP Address Diagnostic Test	192.168.1.220
Start the Diagnostic Test	

6 System Settings

Set related system parameters to optimize the performance of the device.

Tap **System** on the **Main Menu** interface to set the related system parameters to optimize the performance of the device.

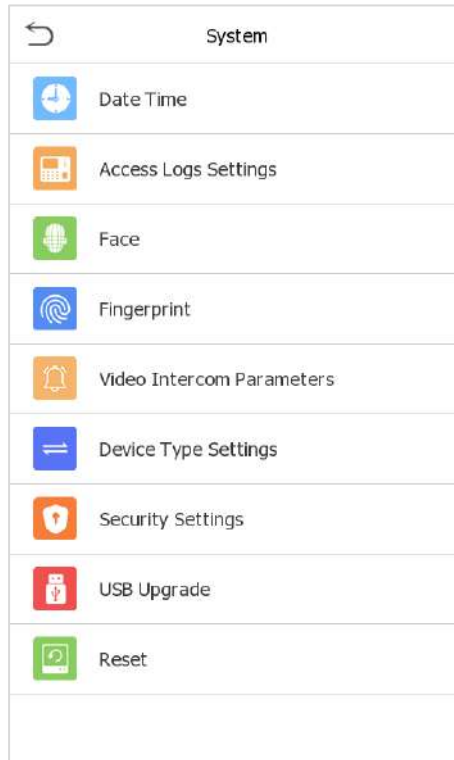

6.1 Date and Time

Tap **Date Time** on the **System** interface to set the date and time.

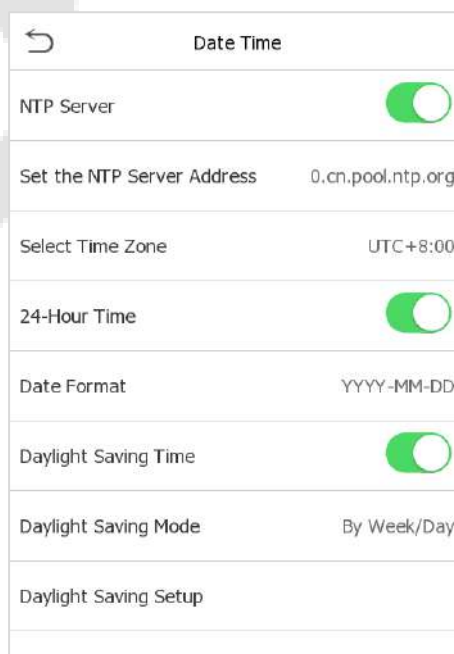

- The product supports the NTP synchronization time system by default. This function takes effect after **NTP Server** is enabled and the corresponding NTP server address link is set.
- If users need to set date and time manually, disable **NTP Server** first, and then tap **Manual Data and Time** to set date and time and tap **Confirm** to save.

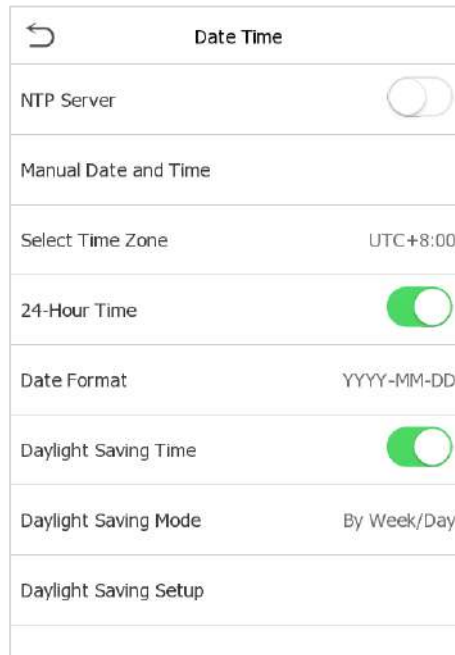

- Tap **24-Hour Time** to enable or disable this format. If enabled, then select the **Date Format** to set the date format.
- Tap **Daylight Saving Time** to enable or disable the function. If enabled, tap **Daylight Saving Mode** to select a daylight-saving mode and then tap **Daylight Saving Setup** to set the switch time.

Daylight Saving Setup	
Start Month	7
Start Week	4
Start Day	Thursday
Start Time	11:06
End Month	7
End Week	4
End Day	Thursday
End Time	12:08

Week mode

Daylight Saving Setup	
Start Date	07-27
Start Time	11:03
End Date	07-27
End Time	12:05

Date mode

- When restoring the factory settings, the time (24-hour) and date format (YYYY-MM-DD) can be restored, but the device date and time cannot be restored.

Note: For example, the user sets the time of the device (18:35 on March 15, 2019) to 18:30 on January 1, 2020. After restoring the factory settings, the time of the equipment will remain 18:30 on January 1, 2020.

6.2 Access Logs Settings

Click **Access Logs Settings** on the System interface.

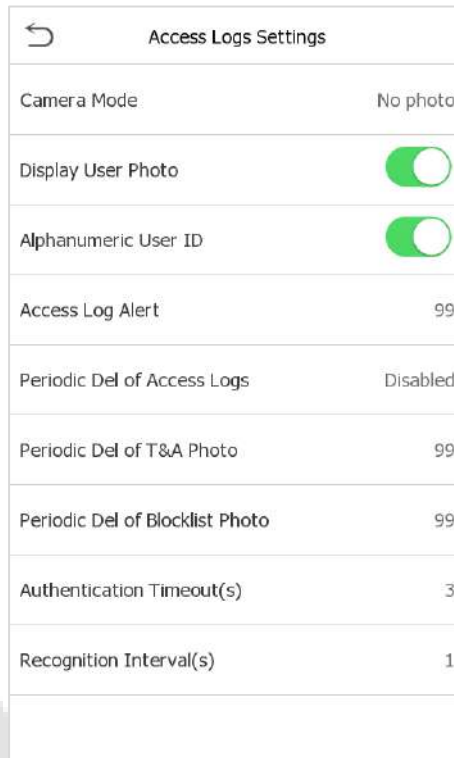

Function Description

Function Name	Description
Camera Mode	<p>This function is disabled by default. When enabled, a security prompt will pop-up and the sound of shutter in the camera will turn on mandatorily. There are 5 modes:</p> <p>No Photo: No photo is taken during user verification.</p> <p>Take photo, no save: Photo is taken but is not saved during verification.</p> <p>Take photo and save: Photo is taken and saved during verification.</p> <p>Save on successful verification: Photo is taken and saved for each successful verification.</p> <p>Save on failed verification: Photo will be taken and saved only for each failed verification.</p>
Display User Photo	<p>This function is disabled by default. When enabled, there will be a security prompt.</p>

Alphanumeric User ID	Decides whether to support letters in a User ID.
Access Logs Alert	When the record space of the attendance access reaches the maximum threshold value, the device will automatically display the memory space warning. Users may disable the function or set a valid value between 1 and 9999.
Periodic Del of Access Logs	When access records have reached full capacity, the device will automatically delete a set of old access records. Users may disable the function or set a valid value between 1 and 999.
Periodic Del of T&A Photo	When attendance photos have reached full capacity, the device will automatically delete a set of old attendance photos. Users may disable the function or set a valid value between 1 and 99.
Periodic Del of Blocklist Photo	When block listed photos have reached full capacity, the device will automatically delete a set of old block listed photos. Users may disable the function or set a valid value between 1 and 99.
Authentication Timeout(s)	The time length of the message of successful verification displays. Valid value: 1~9 seconds.
Recognition Interval (s)	To set the facial template matching time interval as required. Valid value: 0~9 seconds.

6.3 Face Template Parameters

Tap **Face** on the **System** interface to go to the face template parameter settings.

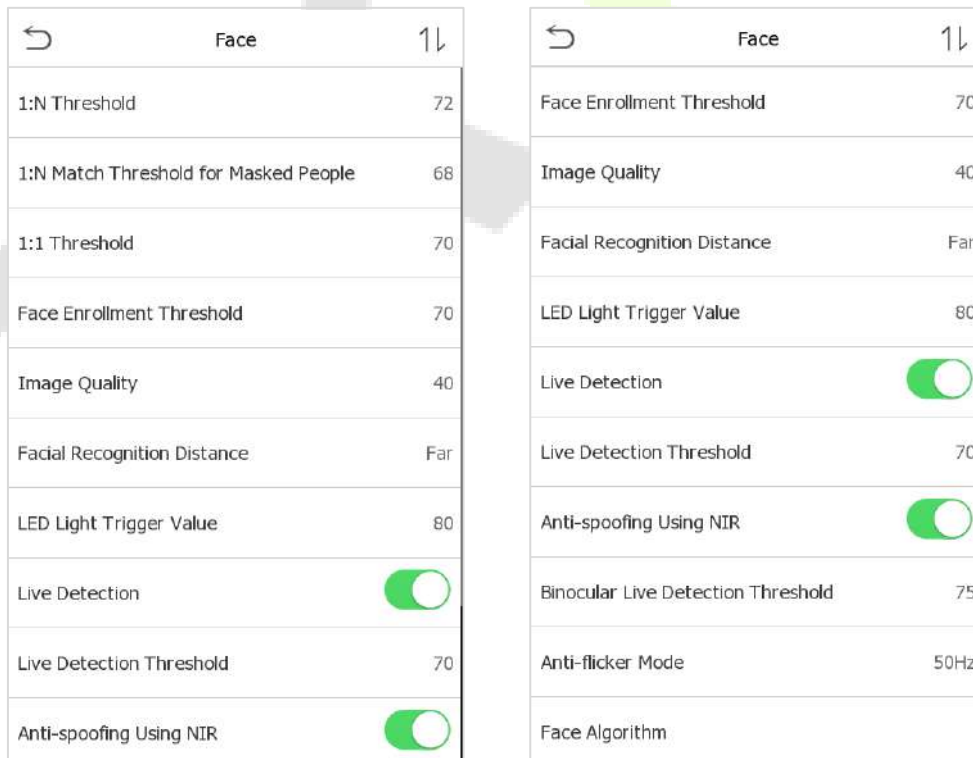

FRR	FAR	Recommended Matching Thresholds	
		1:N	1:1
High	Low	85	80
Medium	Medium	82	75
Low	High	80	70

Function Description

Function Name	Description
1:N Threshold	<p>Under 1:N verification mode, the verification will only be successful when the similarity between the acquired facial image and all registered facial templates is greater than the set value.</p> <p>The valid value ranges from 0 to 100. The higher the thresholds, the lower the misjudgement rate, the higher the rejection rate, and vice versa. It is recommended to set the default value of 75.</p>
1:N Match Threshold for Masked People	<p>Under 1:N verification mode, the device will perform similarity matching between the face template currently wearing the mask and the registered face template template in the device. When the similarity is greater than this value, it means the matching is successful, otherwise it means the matching fails.</p> <p>The valid value ranges from 0 to 100. The higher the thresholds, the lower the misjudgement rate and the higher the rejection rate, and vice versa. It is recommended to set the default value of 68.</p>
1:1 Threshold	<p>Under 1:1 verification mode, the verification will only be successful when the similarity between the acquired facial image and the user's facial templates enrolled in the device is greater than the set value.</p> <p>The valid value ranges from 0 to 100. The higher the thresholds, the lower the misjudgement rate, the higher the rejection rate, and vice versa. It is recommended to set the default value of 63.</p>
Face Enrollment Threshold	<p>During face template enrollment, 1:N comparison is used to determine whether the user has already registered before.</p> <p>When the similarity between the acquired facial image and all registered facial templates is greater than this threshold, it indicates that the face template has already been registered.</p>
Image Quality	<p>Image quality for facial registration and comparison. The higher the value, the clearer the image requires.</p>
Facial Recognition Distance	<p>Face template recognition of the maximum distance, greater than this value will be filtered. The parameter value can be understood as the face template size required for registration and comparison. The farther the distance from people, the smaller the face template pixels obtained by the algorithm. When the value is 0, it means that the face template comparison distance is not limited.</p>
LED Light Triggered Value	<p>This value controls the on and off the LED light. The larger the value, the more frequently the LED light will be turned on.</p>

Live Detection	Detecting the spoof attempt using visible light images to determine if the provided biometric source sample is really a person (a live human being) or false representation.
Live Detection Threshold	Facilitates to judge whether the captured visible image is really a person (a live human being). The larger the value, the better the anti-spoofing performance using visible light.
Anti-spoofing using NIR	Using near-infrared spectra imaging to identify and prevent fake photos and videos attack.
Binocular Live Detection Threshold	It is convenient to judge whether the near-infrared spectral imaging is fake photo and video. The larger the value, the better the anti-spoofing performance of near-infrared spectral imaging.
Anti-flicker Mode	Used when WDR is turned off. This helps reduce flicker when the device's screen flashes at the same frequency as the light.
Face Algorithm	Facial algorithm related information and pause facial template update.
Notes	Improper adjustment of the exposure and quality parameters may severely affect the performance of the device. Please adjust the exposure parameter only under the guidance of the after-sales service personnel of our company.

6.4 Fingerprint Parameters

Click **Fingerprint** on the System interface.

Fingerprint	
1:1 Threshold	15
1:N Threshold	35
FP Sensor Sensitivity	Low
1:1 Retry Attempts	3
Fingerprint Image	None

FRR	FAR	Recommended matching thresholds	
		1:N	1:1
High	Low	45	25
Medium	Medium	35	15
Low	High	25	10

Function Description

Function Name	Descriptions
1:1 Match Threshold	Under 1:1 verification method, the verification will only be successful when the similarity between the acquired fingerprint data and the fingerprint template associated with the entered user ID enrolled in the device is greater than the set value.



1:N Match Threshold	Under 1:N verification method, the verification will only be successful when the similarity between the acquired fingerprint data and the fingerprint templates enrolled in the device is greater than the set value.
FP Sensor Sensitivity	To set the sensibility of fingerprint acquisition. It is recommended to use the default level " Medium ". When the environment is dry, resulting in slow fingerprint detection, you can set the level to " High " to raise the sensibility; when the environment is humid, making it hard to identify the fingerprint, you can set the level to " Low ".
1:1 Retry Times	In 1:1 Verification, users might forget the registered fingerprint, or press the finger improperly. To reduce the process of re-entering user ID, retry is allowed.
Fingerprint Image	<p>This function is disabled by default. After disabling it, the fingerprint image will not be displayed when registering and verifying fingerprints. The menu interface allows to enable or disable this function, and there are security prompts when switching. Four choices are available:</p> <p>Show for enroll: to display the fingerprint image on the screen only during enrollment.</p> <p>Show for match: to display the fingerprint image on the screen only during verification.</p> <p>Always show: to display the fingerprint image on screen during enrollment and verification.</p> <p>None: not to display the fingerprint image.</p>

6.5 Video Intercom Parameters★

Click **Video intercom Parameters** on the System interface.

6.5.1 Connecting to the ZSmart APP

6.5.1.1 Adding Device on the ZSmart APP

After downloading and installing the ZSmart APP on your phone, create a user account initially with your Email ID. After creating the User account, log in to the APP, and click  or  icon on the top right corner of the screen to add a device. The process is as follows:

1. Click **Add Device** on the Home page.
2. Tap on **System > Video Intercom Parameters > QR Code Binding** to show the QR code of the device.
3. Click the  icon in the upper right corner.

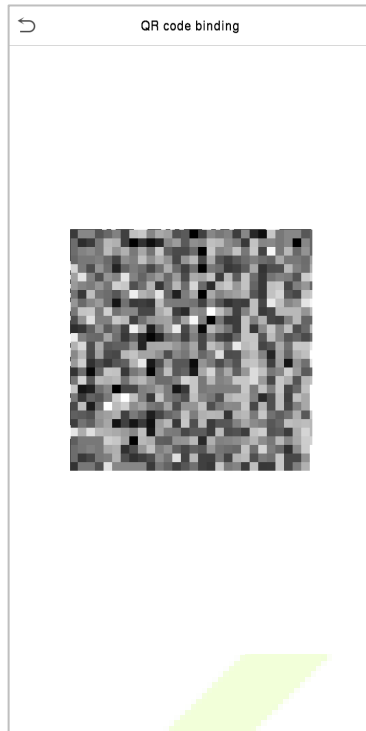
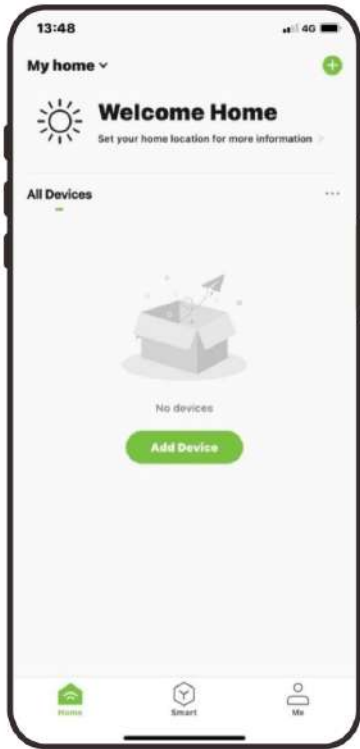

6.5.1.2 Video Phone Connection

Visitors press the  button on the device to make a call and the phone will ring. The user can accept or decline the call. After the user accepts the call, it will open the video door phone interface. Enter the password to unlock the door.



Function Name	Description
Screenshot	Click to take a screenshot.
Speak	The icon becomes blue when click it, and you can talk to the device at this time.
Record	Click to make a record video.
Photo album	View and delete screenshots and recorded videos.
Unlock	Click to open the door remotely. The unlocking record is saved in Me > Message Center .

Note: For other specific operations, please refer to the *ZSmart APP User Manual*.

6.5.2 Connecting to SIP

Note: The SIP Server function is enabled by default. When this function is enabled, the Contact List and Multi-Tenants Calling menu are not displayed. To use Contact List and Multi-Tenants Calling, turn off the SIP Server.

6.5.2.1 Connecting to SIP Server

Note: This function needs to be used with the indoor station. When the SIP server is enabled, it is advised to select TCP mode first and UDP mode second, because TCP mode is more stable.

Tap **SIP Settings** on the **Video intercom Parameters** interface to go to the monitoring parameter settings.

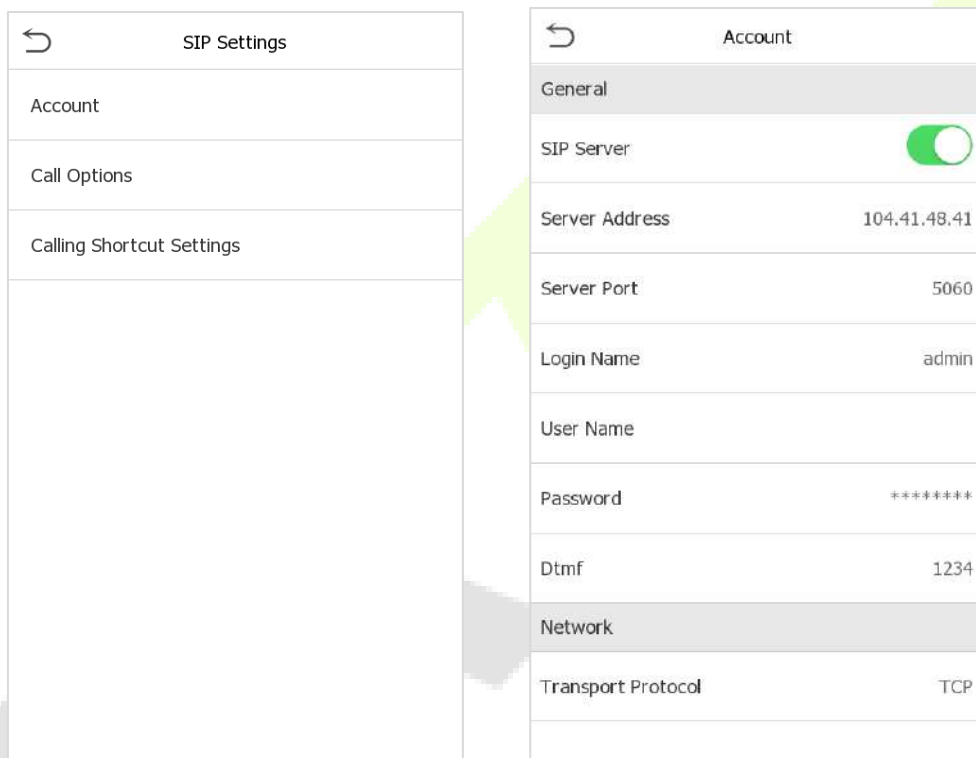

Function Description

Function Name		Description
Account	SIP Server	Select whether to enable the server address. Once you have connected to the server, you can call it by entering the username of the indoor station.
	Server Address	Enter the server address.
	Server Port	Enter the server port.
	Login Name	Enter the login name of server.
	User Name	Enter the Username of server.
	Password	Enter the password of server.

	Dtmf	The value of WebServer is the same as the value of DMTF in the device to unlock it.
	Transport Protocol	Set the transport protocol between SpeedFace-V4L Pro and indoor station. Note: When the SIP server is enabled, it is advised to select TCP mode first and UDP mode second, because TCP mode is more stable. When the SIP Server is disabled and the LAN is used, the UDP mode is selected first.
Call Options	Calling Delay(s)	Set the time of call, valid value 30 to 60 seconds.
	Talking Delay(s)	Set the time of intercom, valid value 60 to 120 seconds.
	Encryption	When enable, the communication of video intercom will be encrypted.
Calling Shortcut Settings		You can set a shortcut key to call the indoor station quickly without entering the IP address of the indoor unit each time.

1. On SpeedFace-V4L Pro, tap **SIP Settings** on the **Video intercom Parameters** interface, after the device is rebooted, enter the server-related parameters.
2. Once the SIP is set up correctly, a green dot will appear in the upper right corner of the call page to indicate that the SpeedFace-V4L Pro is connected to the server. You can call the account name of the indoor station.

Note: SIP is an optional feature, when users need to enable SIP server, they need to purchase the server address and password from the distributor.

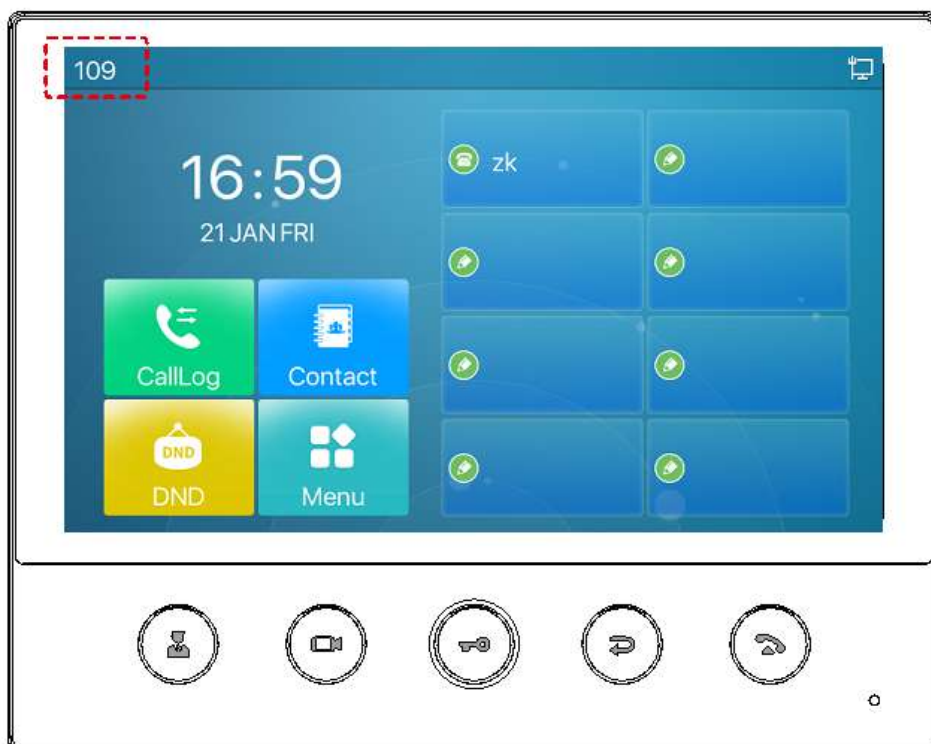

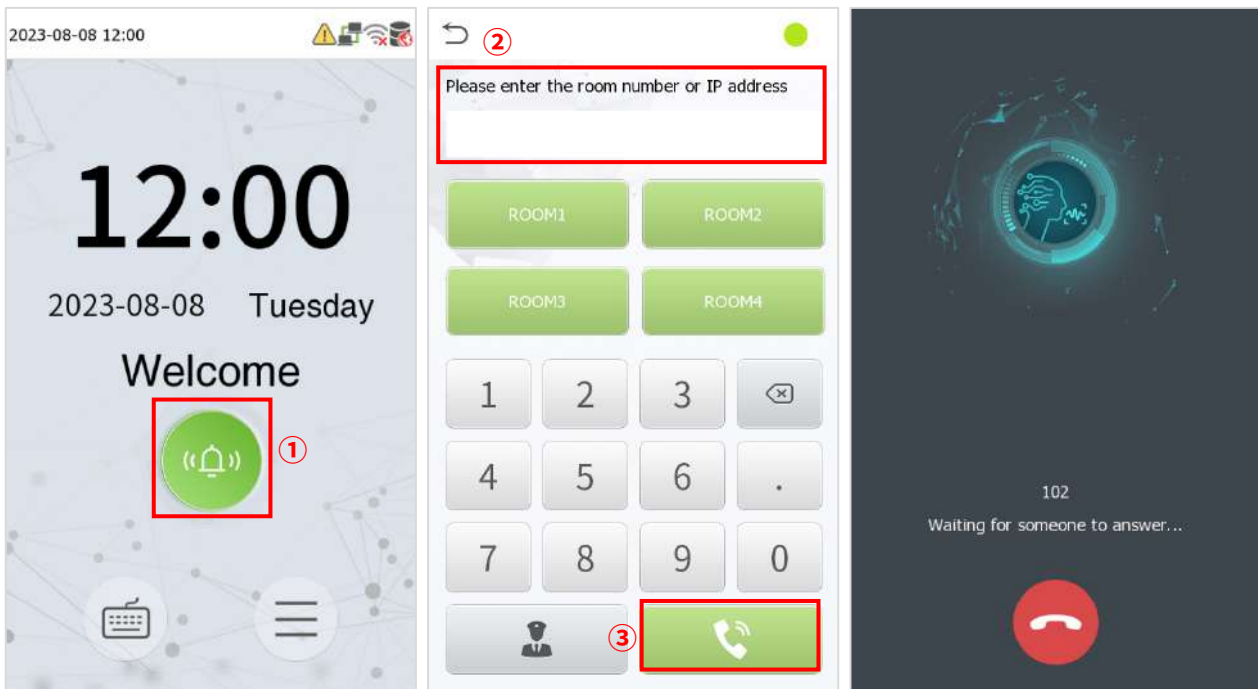

For details on the operation and use of the indoor station, please refer to the *Indoor Station User Manual*.

6.5.2.2 Local Area Network Use

Note: This function needs to be used with the indoor station. When the SIP Server is disabled and the LAN is used, the UDP mode is selected first.

Set the IP address on the indoor station, Tap **Menu > Advanced > Network > 1. Network > 1. IPv4**.

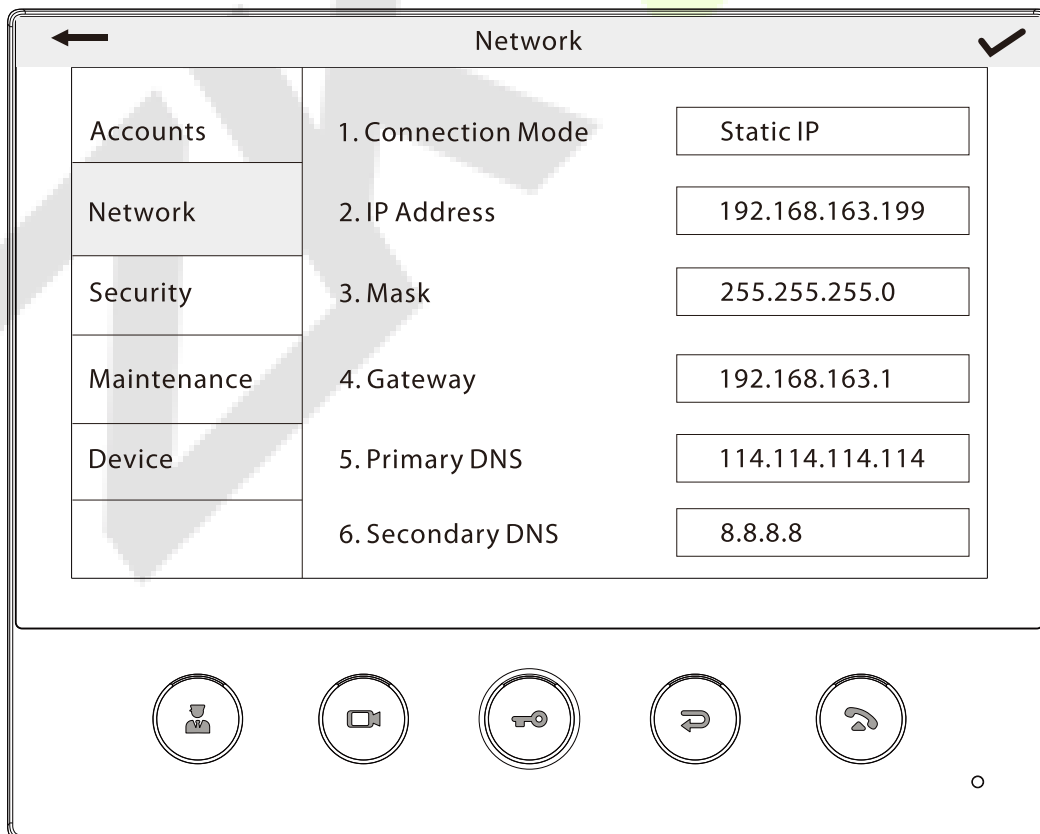

- **Directly Enter the IP Address of the Indoor Station**

Once the indoor station is configured with the network, the video intercom function can be realized by tap the icon  on the SpeedFace-V4L Pro screen and entering the IP address of the indoor station in the jumping interface.

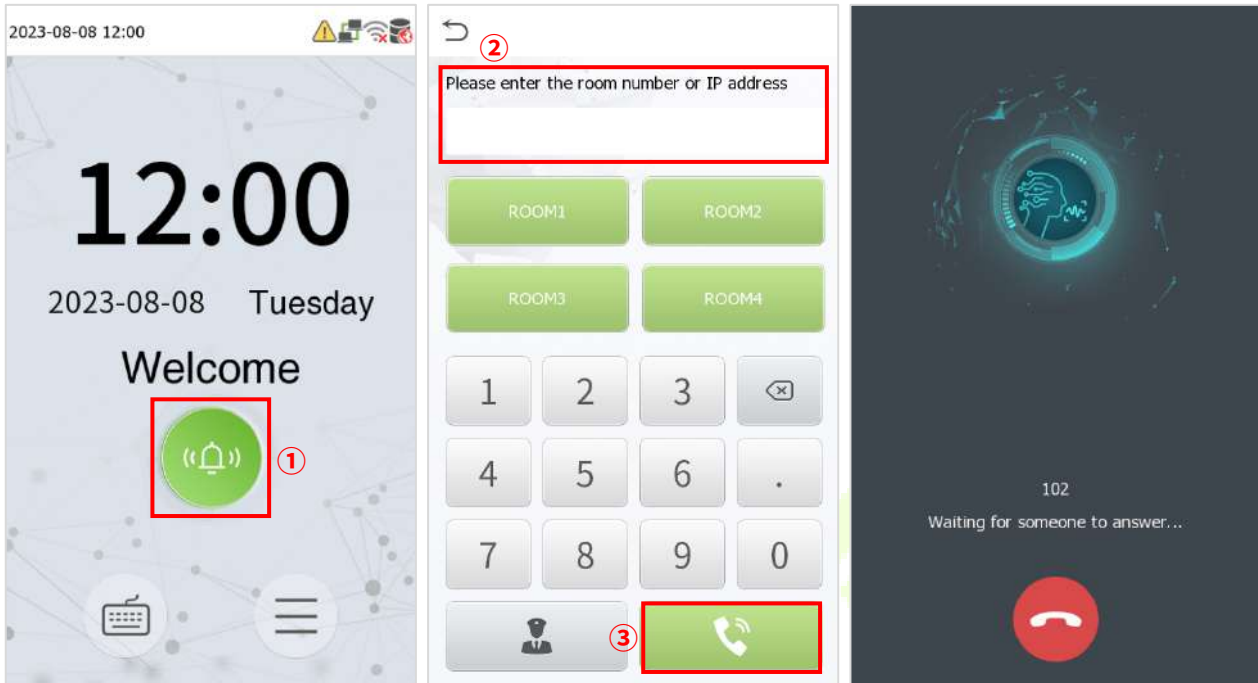

- **Add Contact List**

Note: If you want to enable this function, please ensure that the SIP Server has been turned off.

1. Tap **SIP Settings** > **Contact List** on the **Video intercom Parameters** interface.

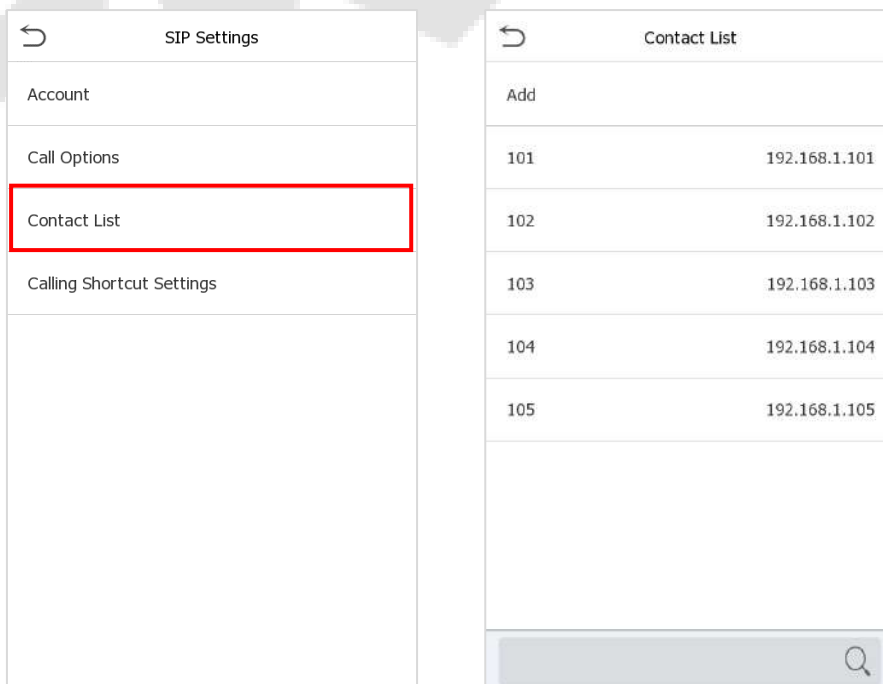

- Click **Add**, input device number and call address to add a new contact member.

Note: Call address and the SpeedFace-V4L Pro must be in the same network segment.

Function Description

Function Name	Description
Device Number	It is the dialing number in the configuration data, you can enter the value on SpeedFace-V4L Pro to call the indoor station quickly for video intercom.
Call Address	The IP address on the indoor station.

- On SpeedFace-V4L Pro, tap **Calling Shortcut Settings**, select any item except admin, and enter the form information you just uploaded.

Function Description

Function Name	Description
Name	You can customize any character (support Chinese, English, numbers, symbols, etc.) that will be displayed on the call page.
Device Number	It is the dialing number in the configuration data, you can enter the value on SpeedFace-V4L Pro to call the indoor station quickly for video intercom.

- Then you can enter the device number or click shortcut key in the call screen to directly implement the video intercom.

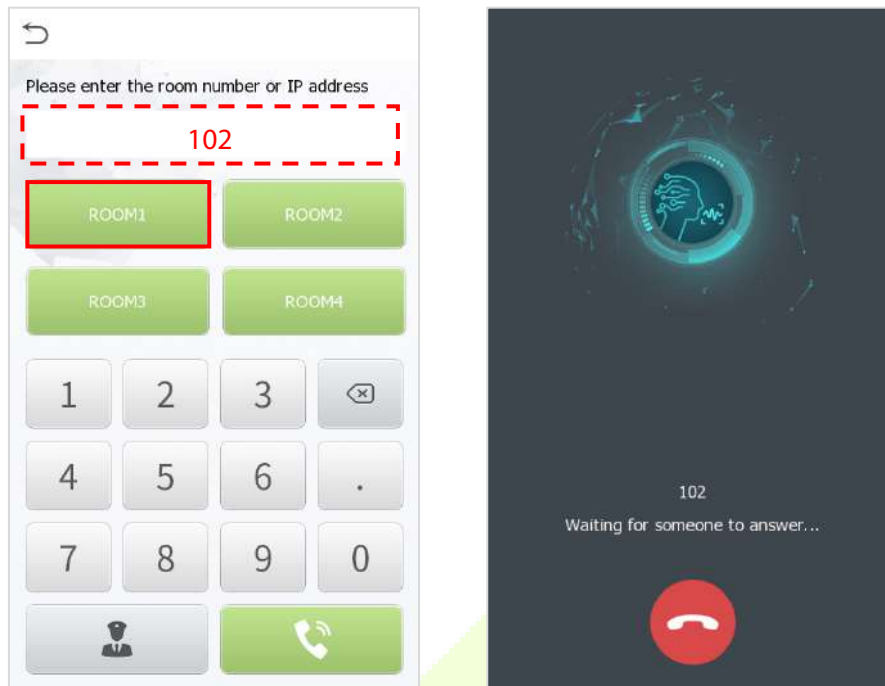

● **Multi-Tenants Calling**

Note: If you want to enable this function, please ensure that the SIP Server has been turned off.

- On the **SIP Settings** interface, click on **Calling Shortcut Settings > Call Mode > Multi-Tenants Calling > Add**. Select the IP addresses of the indoor stations that you want to call, then the indoor stations will be displayed in the list.

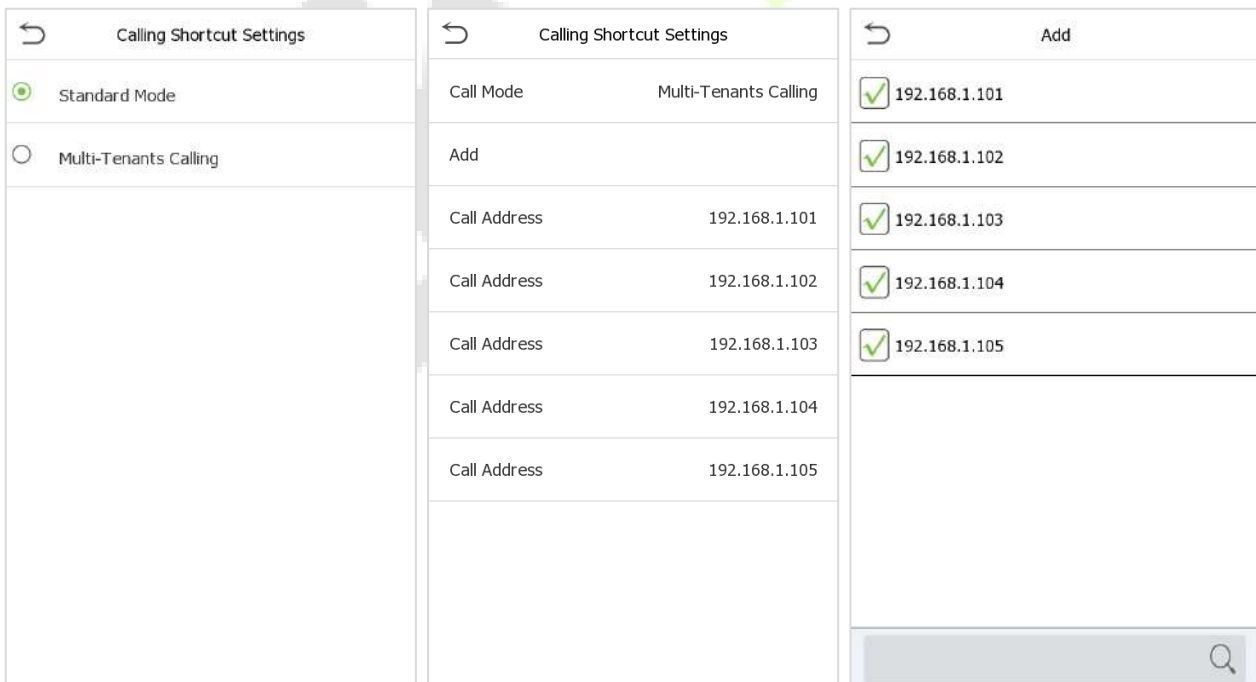

- Then you can tap the  icon on the device to call the indoor stations at the same time.

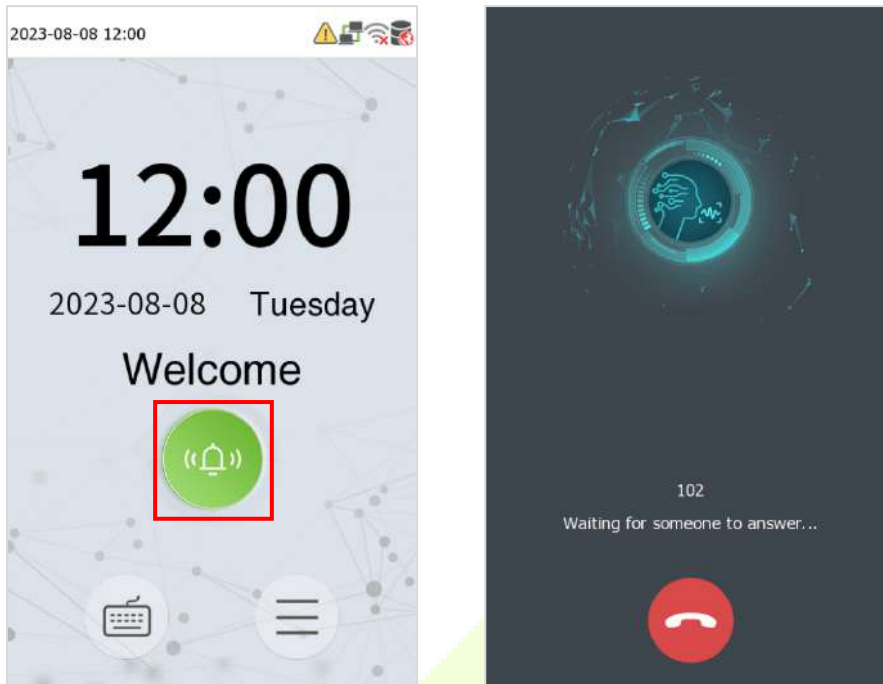

6.6 Device Type Setting

Tap **Device Type Setting** on the System interface.

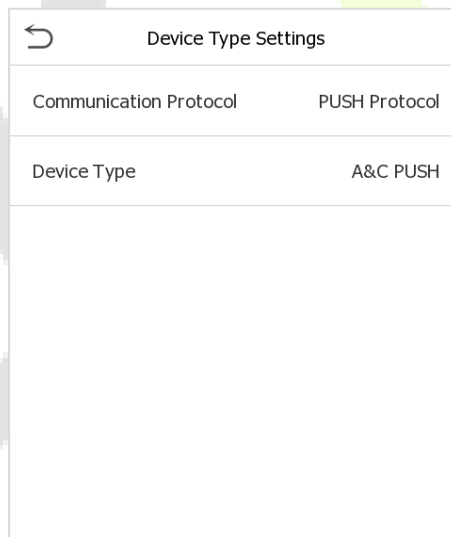

Function Description

Function Name	Description
Communication Protocol	Set the device communication protocol. (BEST protocol is managed by ZKBio Zlink, please refer to 15 Connecting to ZKBio Zlink Web.)
Device Type	Set the device as time attendance terminal (T&A PUSH) or access control terminal (A&C PUSH).

6.7 Security Setting

Tap **Security Setting** on the **System** interface.

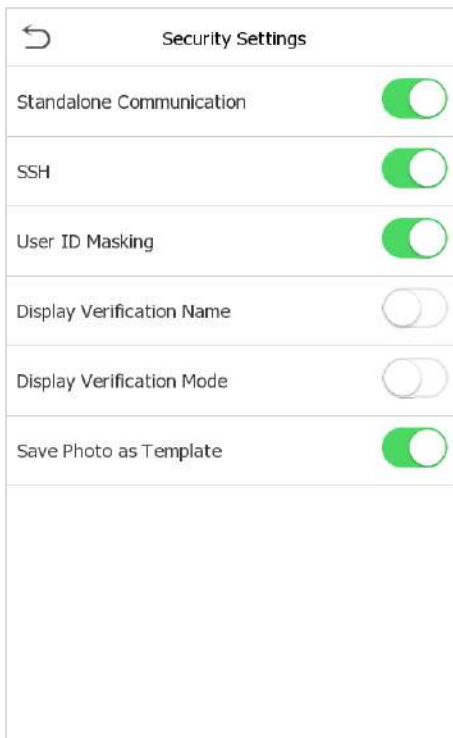

Function Description

Function Name	Description
Standalone Communication	By default, this function is disabled. This function can be enabled or disabled via the menu interface. When it is switched on, a security prompt appears, and the device will restart after you confirm.
SSH	The device does not support the Telnet feature, hence SSH is typically used for remote debugging. By default, SSH is enabled. The menu interface allows you to enable and disable SSH. When enabled, there will be a security prompt, but the device will not need to be restarted after confirmation.
User ID Masking	After enabled, the User ID will be partially displayed after the personnel verification result (only the User ID with more than 2 digits supports the masking display), and it is enabled by default.
Display Verification Name	After enabled, the user's name will be displayed after the personnel verification result. The verification result will not show the name after disabling it.
Display Verification Mode	After enabled, the personnel verification result will show the user's verification mode. The verification result will not show the verification mode after you disable it.
Save Photo as Template	After disabling this function, face template re-registration is required after an algorithm upgrade.

6.8 USB Upgrade

Tap **USB Upgrade** on the **System** interface.

The device's firmware program can be upgraded with the upgrade file in a USB drive. Before conducting this operation, please ensure that the USB drive contains the correct upgrade file and is properly inserted into the device.

If no USB disk is inserted in, the system gives the following prompt after you tap **USB Upgrade** on the System interface.



Note: If upgrade file is needed, please contact our technical support. Firmware upgrade is not recommended under normal circumstances.

6.9 Factory Reset

The Factory Reset function restores the device settings such as communication settings and system settings, to the default factory settings (This function does not clear registered user data).

Tap **Reset** on the **System** interface and then tap **OK** to restore the default factory settings.

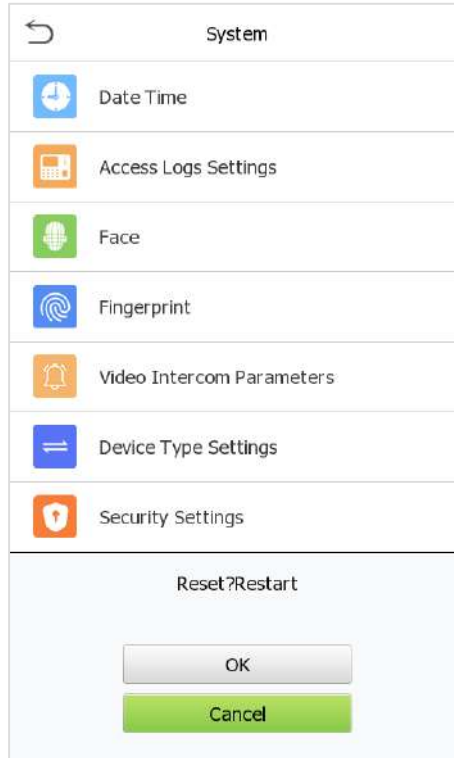

7 Personalize Settings

Tap **Personalize** on the **Main Menu** interface to customize interface settings, voice, bell, punch state options and shortcut key mappings.

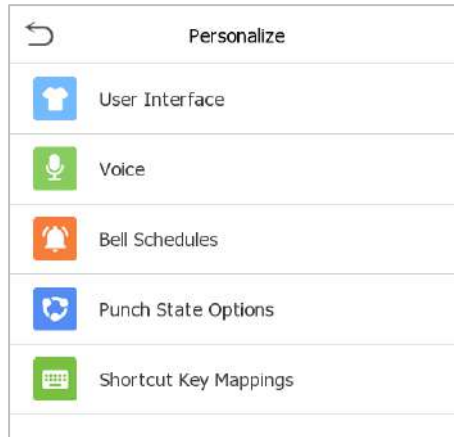

7.1 User Interface Settings

Tap **User Interface** on the **Personalize** interface to customize the display style of the main interface.

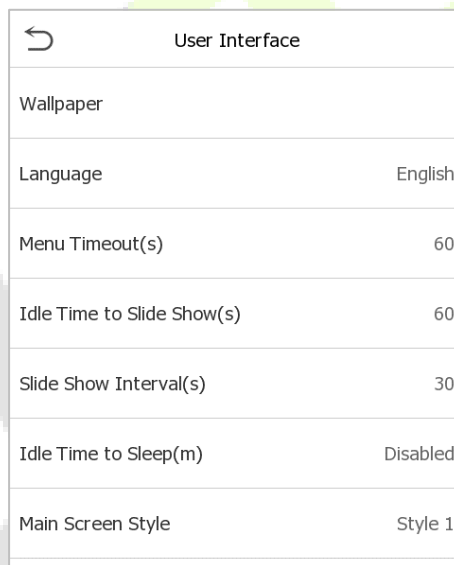

Function Description

Function Name	Description
Wallpaper	The main screen wallpaper can be selected according to the user preference.
Language	Select the language of the device.
Menu Timeout (s)	When there is no operation, and the time exceeds the set value, the device will automatically go back to the initial interface. The function either can be disabled or set the required value between 60 and 99999 seconds.

Idle Time to Slide Show (s)	When there is no operation, and the time exceeds the set value, a slide show will be played. The function can be disabled, or you may set the value between 3 and 999 seconds.
Slide Show Interval (s)	It is the time interval in switching between different slide show photos. The function can be disabled, or you may set the interval between 3 and 999 seconds.
Idle Time to Sleep (m)	If the sleep mode is activated, and when there is no operation in the device, then the device will enter standby mode. Tap the screen anywhere to resume normal working mode. This function can be disabled or set a value within 1-999 minutes.
Main Screen Style	The main screen style can be selected according to the user preference.

7.2 Voice Settings

Tap **Voice** on the **Personalize** interface to configure the voice settings.

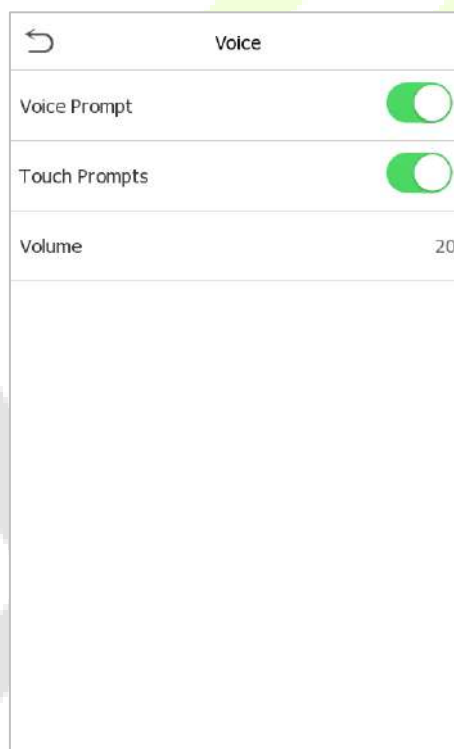

Function Description

Function Name	Description
Voice Prompt	Toggle to enable or disable the voice prompts during function operations.
Touch Prompt	Toggle to enable or disable the keypad sounds.
Volume	Adjust the volume of the device which can be set between 0 to 100.

7.3 Bell Schedules

Tap **Bell Schedules** on the **Personalize** interface to configure the Bell settings.

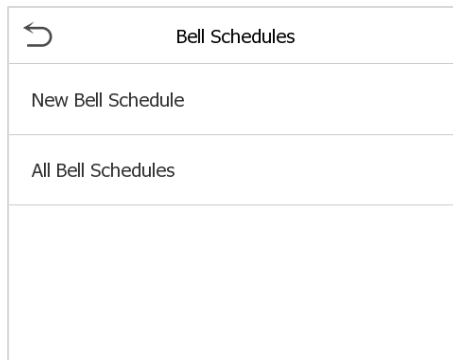

- New bell schedule**

Tap **New Bell Schedule** on the **Bell Schedule** interface to add a new bell schedule.

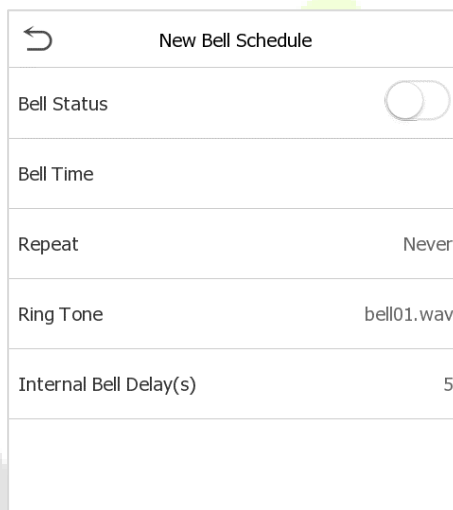

Function Description

Function Name	Description
Bell Status	Toggle to enable or disable the bell status.
Bell Time	Once the required time is set, the device will automatically trigger to ring the bell during that time.
Repeat	Set the required number of counts to repeat the scheduled bell.
Ring Tone	Select a ring tone.
Internal Bell Delay(s)	Set the replay time of the internal bell. Valid values range from 1 to 999 seconds.

- All bell schedules:**

Once the bell is scheduled, on the **Bell Schedules** interface, tap **All Bell Schedules** to view the newly scheduled bell.

- **Edit the scheduled bell:**

On the **All Bell Schedules** interface, tap on the required bell schedule, and tap **Edit** to edit the selected bell schedule. The editing method is the same as the operations of adding a new bell schedule.

- **Delete a bell:**

On the **All Bell Schedules** interface, tap the required bell schedule, and tap **Delete**, and then tap **Yes** to delete the selected bell.

7.4 Punch States Options★

Tap **Punch States Options** on the **Personalize** interface to configure the punch state settings.

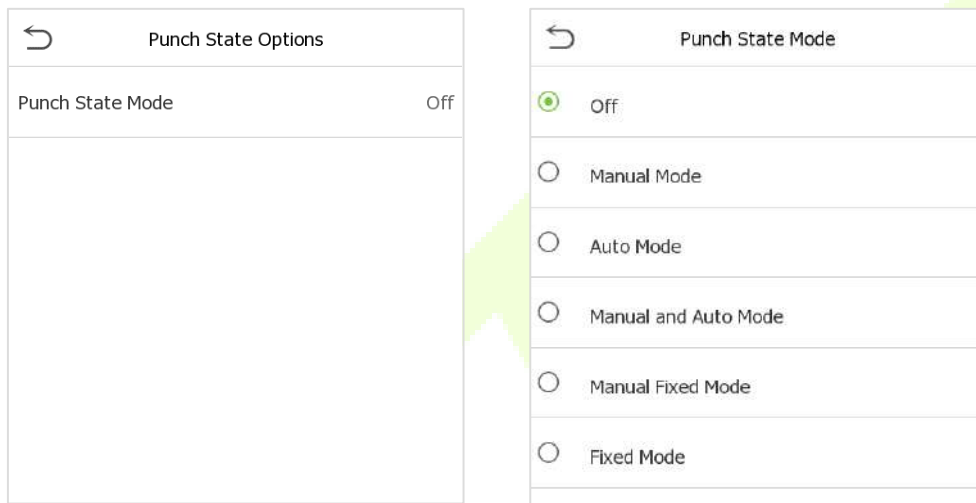

Function Description

Function Name	Description
Punch State Mode	<p>Off: Disable the punch state function. Therefore, the punch state key set under Shortcut Key Mappings menu will become invalid.</p> <p>Manual Mode: Switch the punch state key manually, and the punch state key will disappear after Punch State Timeout.</p> <p>Auto Mode: The punch state key will automatically switch to a specific punch status according to the predefined time schedule which can be set in the Shortcut Key Mappings.</p> <p>Manual and Auto Mode: The main interface will display the auto-switch punch state key. However, the users will still be able to select alternative that is the manual attendance status. After timeout, the manual switching punch state key will become auto-switch punch state key.</p> <p>Manual Fixed Mode: After the punch state key is set manually to a particular punch status, the function will remain unchanged until being manually switched again.</p> <p>Fixed Mode: Only the manually fixed punch state key will be shown. Users cannot change the status by pressing any other keys.</p>

7.5 Shortcut Key Mappings★

Users may define shortcut keys for attendance status and for functional keys which will be defined on the main interface. So, on the main interface, when the shortcut keys are pressed, the corresponding attendance status or the function interface will be displayed directly.

Tap **Shortcut Key Mappings** on the **Personalize** interface to set the required shortcut keys.

Shortcut Key Mappings	
F1	Check-In
F2	Check-Out
F3	Break-Out
F4	Break-In
F5	Overtime-In
F6	Overtime-Out

- On the **Shortcut Key Mappings** interface, tap on the required shortcut key to configure the shortcut key settings.
- On the **Shortcut Key** (that is "F1") interface, tap **function** to set the functional process of the shortcut key either as punch state key or function key.
- If the Shortcut key is defined as a function key (such as New user, All users, etc.), the configuration is completed as shown in the image below.

F1	
Punch State Value	0
Function	Punch State Options
Name	Check-In
Set Switch Time	

F1	
Function	New User

- If the Shortcut key is set as a punch state key (such as check in, check out, etc.), then it is required to set the punch state value (valid value 0~250), name.

Note: When the function is set to Undefined, the device will not enable the punch state key.

- **Set the Switch Time★**

- The switch time is set in accordance with the punch state options.
- When the **punch state mode** is set to **auto mode**, the switch time should be set.

- On the **Shortcut Key** interface, tap **Set Switch Time** to set the switch time.
- On the **Switch Cycle** interface, select the switch cycle (Monday, Tuesday etc.) as shown in the image below.

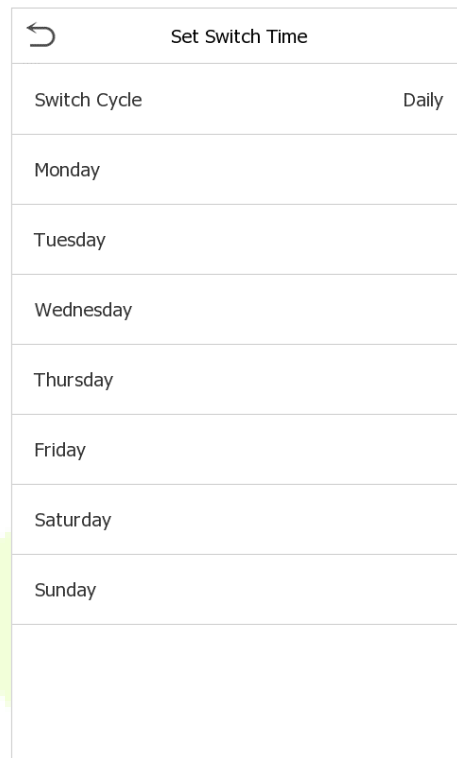
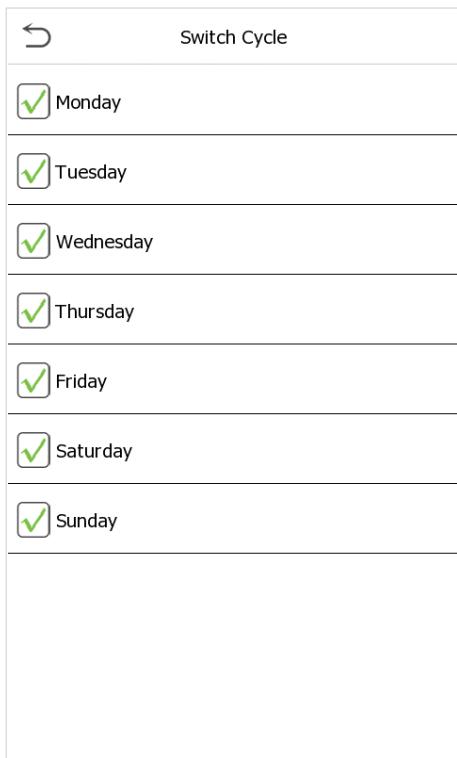

- Once the Switch cycle is selected, set the switch time for each day and tap **OK** to confirm, as shown in the image below.

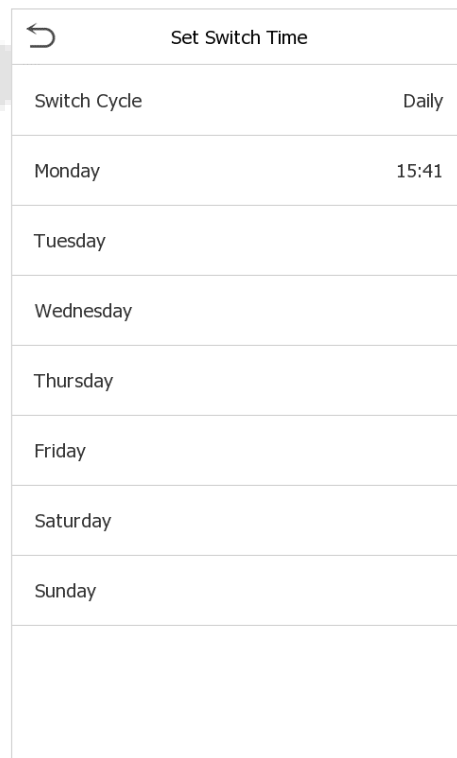
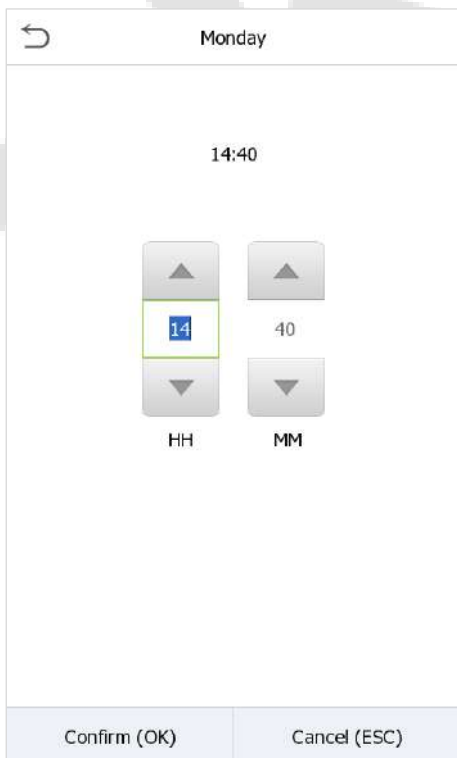

8 Data Management

On the **Main Menu**, tap **Data Mgt.** to delete the relevant data in the device.



8.1 Delete Data

Tap **Delete Data** on the **Data Mgt.** interface to delete the required data.

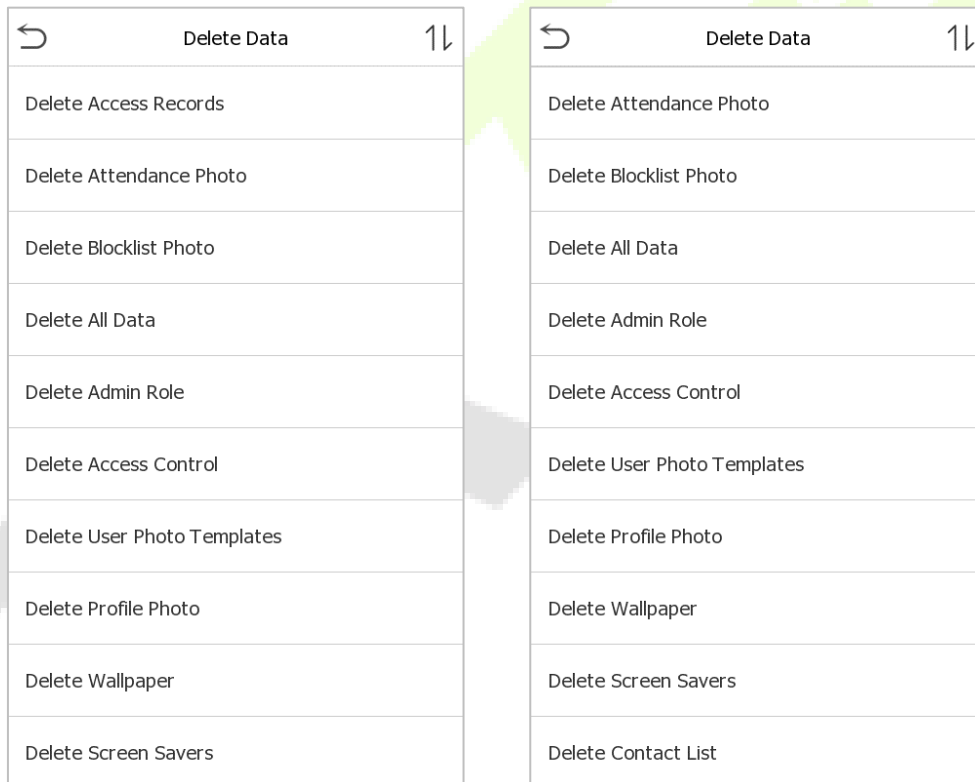

Function Description

Function Name	Description
Delete Access Records	To delete access records conditionally.
Delete Attendance Data★	To delete attendance data conditionally.
Delete Attendance Photo	To delete attendance photos of designated personnel.
Delete Blocklist Photo	To delete the photos taken during failed verifications.

Delete All Data	To delete information and attendance logs/access records of all registered users.
Delete Admin Role	To remove all administrator privileges.
Delete Access Control	To delete all access data.
Delete User Photo Templates	To delete user photo templates in the device. When deleting template photos, there is a risk reminder: “Face re-registration is required after an algorithm upgrade.”
Delete Profile Photo	To delete all user photos in the device.
Delete Wallpaper	To delete all wallpapers in the device.
Delete Screen Savers	To delete the screen savers in the device.
Delete Contact List	To delete all contact list of video intercom in the device.

The user may select Delete All or Delete by Time Range when deleting the access records, attendance photos or block listed photos. Selecting Delete by Time Range, you need to set a specific time range to delete all data within a specific period.

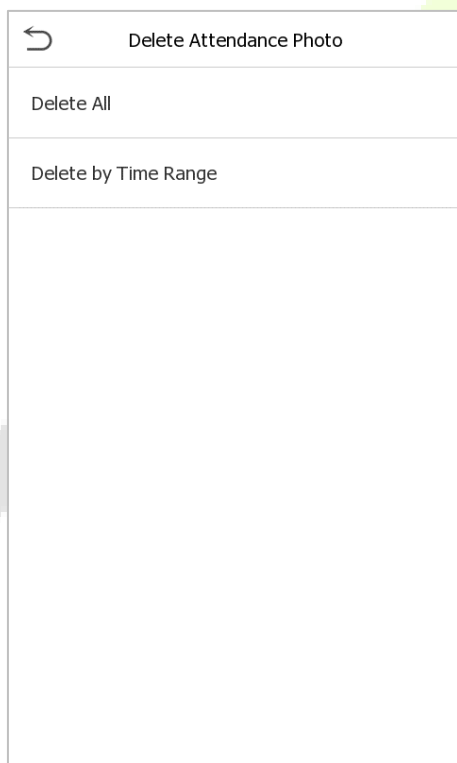

Select **Delete by Time Range**.



Set the time range and click **OK**.

9 Access Control

On the **Main Menu**, tap **Access Control** to set the schedule of door opening, locks control and to configure other parameters settings related to access control.

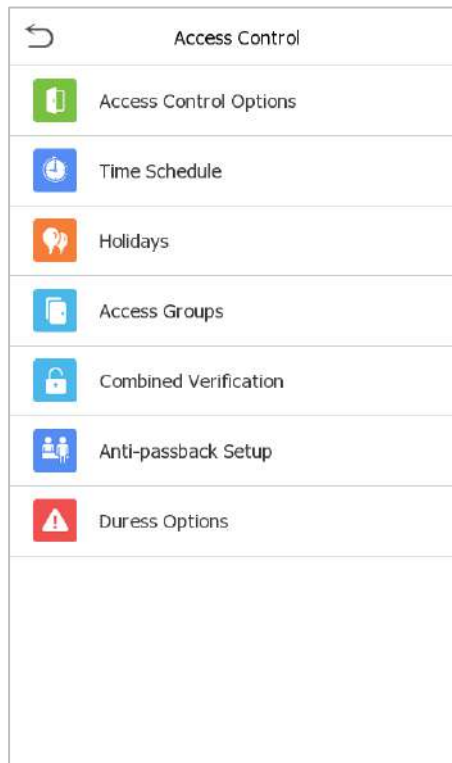

- **To gain access, the registered user must meet the following conditions:**
 - The relevant door's current unlock time should be within any valid time zone of the user time period.
 - The corresponding user's group must be already set in the door unlock combination (and if there are other groups, being set in the same access combo, then the verification of those group's members are also required to unlock the door).
 - In default settings, new users are allocated into the first group with the default group time zone, where the access combo is "1" and is set in unlock state by default.

9.1 Access Control Options

Tap **Access Control Options** on the **Access Control** interface to set the parameters of the control lock of the terminal and related equipment.

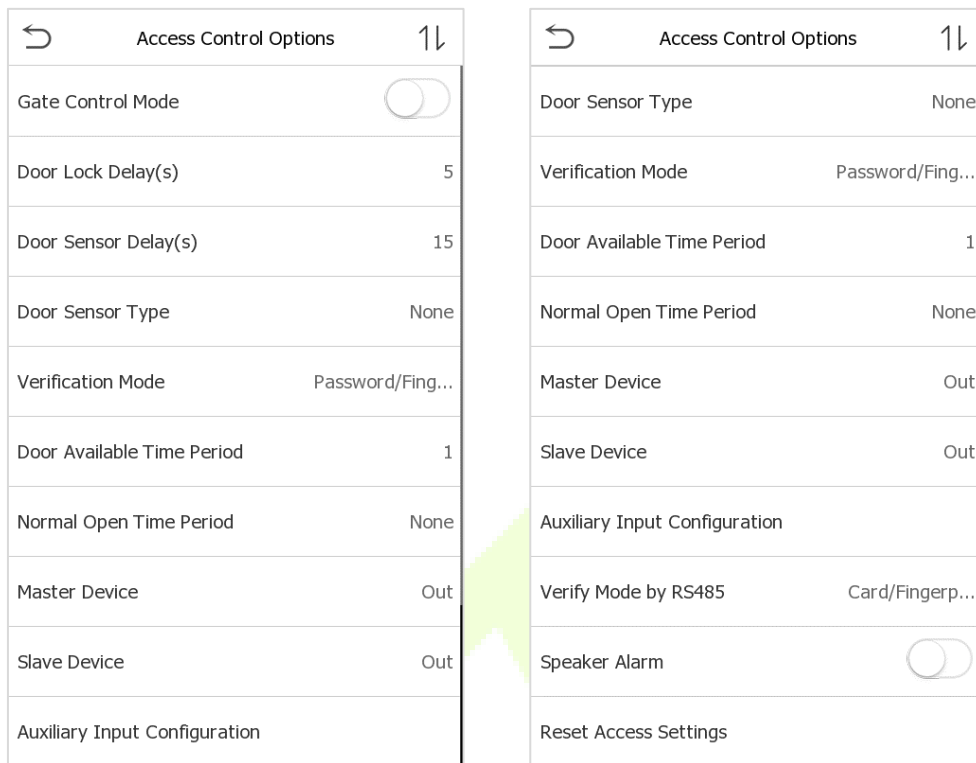

Function Description

Function Name	Description
Gate Control Mode	Toggle between ON or OFF switch to get into gate control mode or not. When set to ON , on this interface will remove Door lock relay, Door sensor relay and Door sensor type options.
Door Lock Delay (s)	The length of time that the device controls the electric lock to be in unlock state. Valid value: 1~10 seconds; 0 second represents disabling the function.
Door Sensor Delay (s)	If the door is not locked and is being left open for a certain duration (Door Sensor Delay), an alarm will be triggered. The valid value of Door Sensor Delay ranges from 1 to 255 seconds.
Door Sensor Type	There are three Sensor types: None , Normal Open and Normal Closed . None: It means door sensor is not in use. Normal Open: It means the door is always left opened when electric power is on. Normal Closed: It means the door is always left closed when electric power is on.
Door Alarm Delay(s)★	When the state of the door sensor is inconsistent with that of the door sensor type, an alarm will be triggered after a specified time period, i.e. the Door Alarm Delay. The valid value ranges from 1 to 999 seconds. 0 means immediate alarm.

Retry Times to Alarm★	When the number of failed verifications reach a set value, which ranges from 1 to 9 times, an alarm will be triggered. If the set value is "None", the alarm will never be triggered due to failed verifications.
Verification Mode	The supported verification mode includes Card/Fingerprint, Fingerprint Only, Card Only, Fingerprint + Password, Card + Password, Card + Fingerprint and Card + Fingerprint + Password.
Door Available Time Period	To set time period for door, so that the door is available only during that period.
Normal Close Time Period★	Scheduled time period for "Normal Close" mode, so that the door is always close during this period.
Normal Open Time Period	Scheduled time period for "Normal Open" mode, so that the door is always left open during this period.
Master Device	When setting up the master, the status of the master can be set to exit on enter. Out: The record verified on the host is the exit record. In: The record verified on the host is the entry record.
Slave Device	When setting up the slave, the status of the slave can be set to exit on enter. Out: The record verified on the host is the exit record. In: The record verified on the host is the entry record.
Auxiliary Input Configuration	Sets the door unlock time period and auxiliary output type of the auxiliary terminal device. Auxiliary output types include None, Trigger door open, Trigger Alarm, Trigger door open and Alarm.
Verify Mode by RS485	The verification mode is used when the device is used either as a host or slave. The supported verification mode includes Card Only and Card + Password.
Valid Holidays★	To set if Normal Close Period or Normal Open Period settings are valid in set holiday time period. Choose ON to enable the functions during holiday.
Speaker Alarm	Transmits a sound alarm or disassembly alarm from the local. When the door is closed or the verification is successful, the system will cancel the alarm from the local.
Reset Access Settings	The access control reset parameters include door lock delay, door sensor delay, door sensor type, verification mode, door available time period, normal open time period, master device, and alarm. However, erased access control data in Data Mgt. is excluded.

9.2 Time Rule Setting

Tap **Time Rule Setting** on the Access Control interface to configure the time settings.

- The entire system can define up to 50 Time Periods.
- Each Time Period represents **10** Time Zones, i.e. **1** week and **3** holidays, and each time zone is a standard 24 hour period per day and the user can only verify within the valid time period.
- One can set a maximum of 3 time periods for every time zone. The relationship among these time periods is "**OR**". Thus, when the verification time falls in any one of these time periods, the verification is valid.
- The Time Zone format of each Time Period: HH MM-HH MM, which is accurate to minutes according to the 24-hour clock.

Tap the grey box to search the required Time Zone and specify the required Time Zone number (maximum: up to 50 zones).

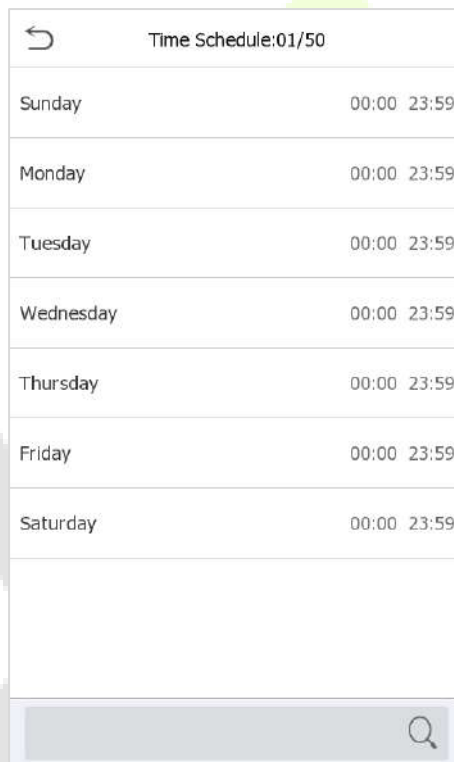

Time Schedule:01/50	
Sunday	00:00 23:59
Monday	00:00 23:59
Tuesday	00:00 23:59
Wednesday	00:00 23:59
Thursday	00:00 23:59
Friday	00:00 23:59
Saturday	00:00 23:59
<input type="text"/>	

On the selected Time Zone number interface, tap on the required day (that is Monday, Tuesday etc.) to set the time.

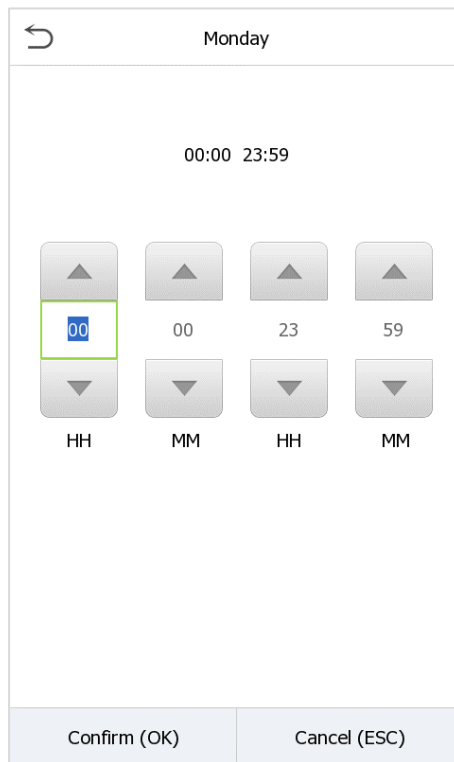

Specify the start and the end time, and then tap **OK**.

Notes:

- When the End Time is earlier than the Start Time, (such as 23:57~23:56), it indicates that access is prohibited all day.
- When the End Time is later than the Start Time, (such as 00:00~23:59), it indicates that the interval is valid.
- The effective Time Period to keep the Door Unlock or open all day is (00:00~23:59) or also when the Ending Time is later than the Starting Time, (such as 08:00~23:59).
- The default Time Zone 1 indicates that door is open all day long.

9.3 Holidays

Whenever there is a holiday, you may need a special access time; but changing everyone's access time one by one is extremely cumbersome, so you can set a holiday access time which is applicable to all employees, and the user will be able to open the door during the holidays.

Tap **Holidays** on the **Access Control** interface to set the Holiday access.

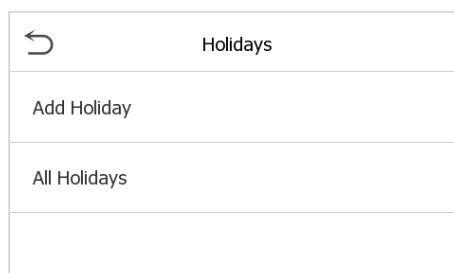

- **Add a new holiday:**

Tap **Add Holiday** on the **Holidays** interface and set the holiday parameters.

Holidays	
No.	1
Start Date	Undefined
End Date	Undefined
Time Period	1

- **Edit a holiday:**

On the **Holidays** interface, select a holiday item to be modified. Tap **Edit** to modify holiday parameters.

- **Delete a Holiday:**

On the **Holidays** interface, select a holiday item to be deleted and tap **Delete**. Press **OK** to confirm deletion. After deletion, this holiday is no longer displayed on **All Holidays** interface.

9.4 Access Groups

This is to easily manage groupings and users in different access groups. Settings of an access group such as access time zones are applicable to all members in the group by default. However, users may manually set the time zones as needed. User authentication takes precedence over group authentication when group authentication modes overlap with the individual authentication methods. Each group can set a maximum of three time zones. By default, newly enrolled users are assigned to Access Group 1; they can be assigned to other access groups.

Click **Access Groups** on the **Access Control** interface.

Access Groups	
New Group	
All Groups	

- **Add a New Group**

Click **New Group** on the Access Groups interface and set access group parameters.

Access Groups	
No.	2
Verification Mode	Password/Fingerprint...
Time Period 1	1
Time Period 2	0
Time Period 3	0
Include Holidays	<input type="checkbox"/>

Notes:

- There is a default access group numbered 1, which cannot be deleted, but can be modified.
- A number cannot be modified after being set.
- When the holiday is set to be valid, personnel in a group may only open the door when the group time zone overlaps with the holiday time period.
- When the holiday is set to be invalid, the access control time of the personnel in a group is not affected during holidays.

9.5 Combined Verification

Access groups are arranged into different door-unlocking combinations to achieve multiple verifications and strengthen the security. In a door-unlocking combination, the range of the combined number N is: $0 \leq N \leq 5$, and the number of members N may all belong to one access group or may belong to five different access groups.

Tap **Combined Verification** on the **Access Control** interface to configure the combined verification setting.

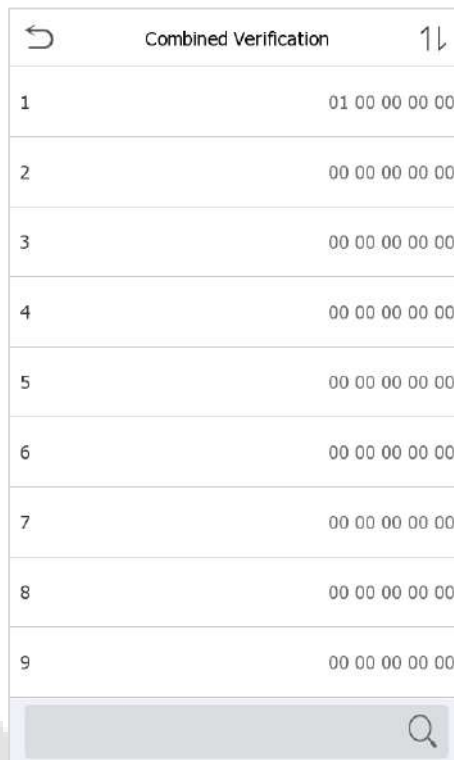

Combination	Code
1	01 00 00 00 00
2	00 00 00 00 00
3	00 00 00 00 00
4	00 00 00 00 00
5	00 00 00 00 00
6	00 00 00 00 00
7	00 00 00 00 00
8	00 00 00 00 00
9	00 00 00 00 00

On the combined verification interface, tap the Door-unlock combination to be set, and tap the **up** and **down** arrows to input the combination number, and then press **OK**.

For Example:

- The **Door-unlock combination 1** is set as **(01 03 05 06 08)**, indicating that the unlock combination 1 consists of 5 people, and the 5 individuals are from 5 groups, namely, **Access Control Group 1** (AC group 1), AC group 3, AC group 5, AC group 6, and AC group 8, respectively.
- The **Door-unlock combination 2** is set as **(02 02 04 04 07)**, indicating that the unlock combination 2 consists of 5 people; the first two are from AC group 2, the next two are from AC group 4, and the last person is from AC group 7.
- The **Door-unlock combination 3** is set as **(09 09 09 09 09)**, indicating that there are 5 people in this combination; all of which are from AC group 9.

- The **Door-unlock combination 4** is set as **(03 05 08 00 00)**, indicating that the unlock combination 4 consists of only three people. The first person is from AC group 3, the second person is from AC group 5, and the third person is from AC group 8.

- **Delete a Door-unlocking Combination:**

Set all Door-unlock combinations to 0 if you want to delete door-unlock combinations.

9.6 Anti-passback Setup

It is possible that users may be followed by some persons to enter the door without verification, resulting in a security breach. So, to avoid such a situation, the Anti-Passback option was developed. Once it is enabled, the check-in record must match with the check-out record so as to open the door.

This function requires two devices to work together: one is installed inside the door (master device), and the other one is installed outside the door (slave device). The two devices communicate via the Wiegand signal. The Wiegand format and Output type (User ID / Card Number) adopted by the master device and slave device must be consistent.

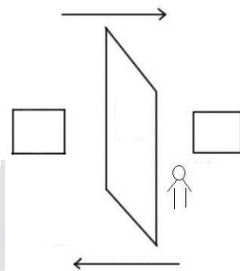

Tap **Anti-passback Setup** on the **Access Control** interface.

Anti-passback Setup	
Anti-passback Direction	No Anti-passba...
Device Status	Out
Slave Device	Out

Function Description

Function Name	Description
Anti-passback Direction	<p>No Anti-passback: Anti-passback function is disabled, which means successful verification through either the master device or slave device can unlock the door. The attendance state is not saved in this option.</p> <p>Out Anti-passback: After a user checks out, only if the last record is a check-in record, the user can check-out again; otherwise, the alarm will be triggered. However, the user can check-in freely.</p> <p>In Anti-passback: After a user checks in, only if the last record is a check-out record, the user can check-in again; otherwise, the alarm will be triggered. However, the user can check-out freely.</p> <p>In/Out Anti-passback: After a user checks in/out, only if the last record is a check-out record, the user can check-in again; or if it is a check-in record, the user can check-out again; otherwise, the alarm will be triggered.</p>
Device Status★	<p>Set the state of the device as Out or In.</p> <p>Out: A record of verification on the device is a check-out record.</p> <p>In: A record of verification on the device is a check-in record.</p>
Slave Device★	<p>While configuring the master and slave devices, you may set the state of the slave as Out or In.</p> <p>Out: A record of verification on the slave device is a check-out record.</p> <p>In: A record of verification on the slave device is a check-in record.</p>

9.7 Duress Options

Once a user activates the duress verification function with specific authentication method(s), and when he/she is under coercion and authenticates using duress verification, the device will unlock the door as usual, but at the same time, a signal will be sent to trigger the alarm.

On **Access Control** interface, tap **Duress Options** to configure the duress settings.

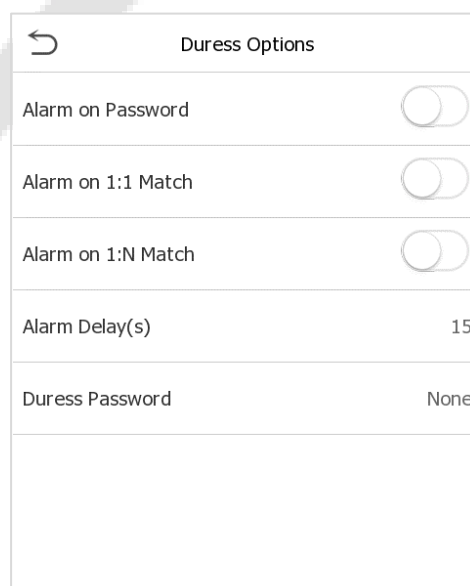

Function Description

Function Name	Description
Alarm on Password	When a user uses the password verification method, an alarm signal will be generated, otherwise there will be no alarm signal.
Alarm on 1:1 Match	When a user uses any fingerprint to perform the 1:1 verification, an alarm signal will be generated, otherwise there will be no alarm signal.
Alarm on 1:N Match	When a user uses any fingerprint to perform 1:N verification, an alarm signal will be generated, otherwise there will be no alarm signal.
Alarm Delay (s)	Alarm signal will not be transmitted until the alarm delay time is elapsed. The value ranges from 1 to 999 seconds.
Duress Password	Set the 6-digit duress password. When the user enters this duress password for verification, an alarm signal will be generated.

10 USB Manager

You can import the user information, and attendance data in the machine to matching attendance software for processing by using a USB disk, or import the user information to other devices for backup.

Before uploading/downloading data from/to the USB disk, insert the USB disk into the USB slot first.

Tap **USB Manager** on the main menu interface.



10.1 USB Download

On the **USB Manager** interface, tap **Download**.

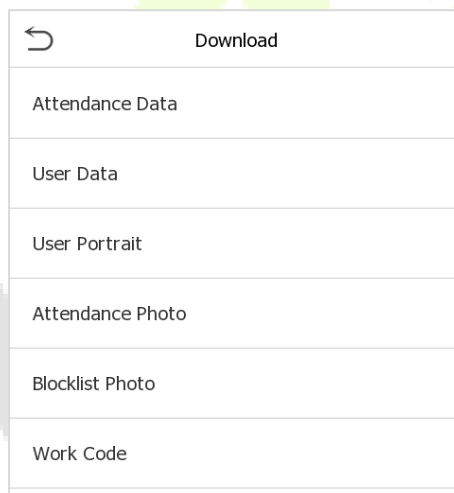

Function Description

Function Name	Description
Attendance Data	To download all attendance data in specified time period into USB disk.
User Data	To download all user information from the device into USB disk.
User Portrait	To download all user portraits from the device into USB disk.
Attendance Photo	To download all attendance photos from the device into USB disk.
Blocklist Photo	To download all blocklisted photos (photos taken after failed verifications) from the device into USB disk.
Work Code★	To download all work code from the device into USB disk.

10.2 USB Upload

On the **USB Manager** interface, tap **Download**.

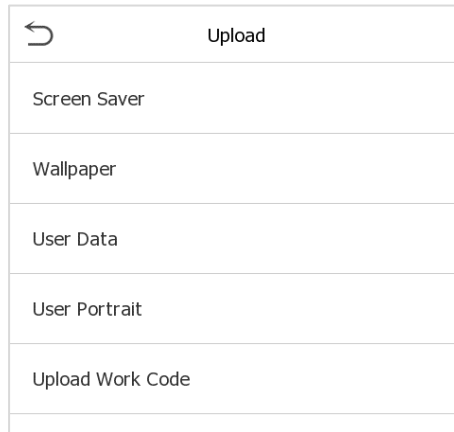

Function Description

Function Name	Description
Screen Saver	To upload all screen savers from USB disk into the device. You can choose Upload selected photo or upload all photos. The images will be displayed on the device's main interface after upload.
Wallpaper	To upload all wallpapers from USB disk into the device. You can choose Upload selected photo or upload all photos. The images will be displayed on the screen after upload.
User Data	To upload all the user information from USB disk into the device.
User Portrait	To upload all user portraits from USB disk into the device.
Upload Work Code★	To upload all work code from USB disk into the device.

10.3 Download Options ★

It is used to encrypt attendance data in the USB disk or delete attendance data. On the **USB Manager** interface, click **Download Options**.

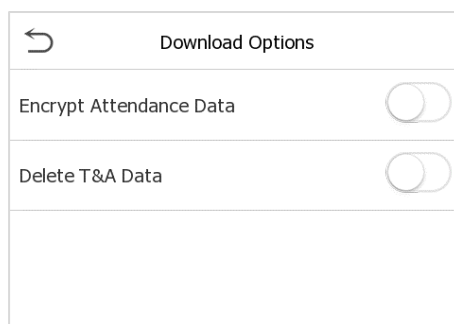

11 Attendance Search

Once the identity of a user is verified, the Event Logs will be saved in the device. This function enables users to check their access records.

Click **Attendance Search** on the **Main Menu** interface to search for the required Access/Attendance log.

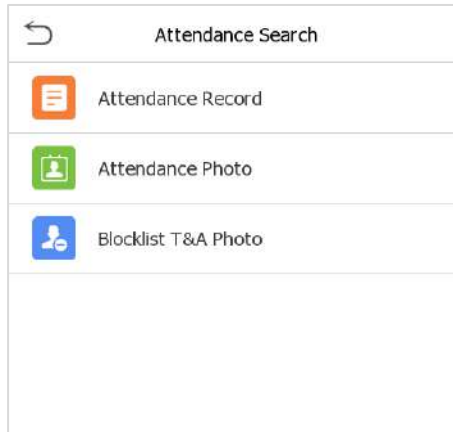

The process of searching for attendance and blocklist photos is similar to that of searching for event logs. The following is an example of searching for event logs.

On the **Attendance Search** interface, tap **Event Logs** to search for the required record.

1. Enter the user ID to be searched and click OK. If you want to search for logs of all users, click OK without entering any user ID.
2. Select the time range in which the logs need to be searched.

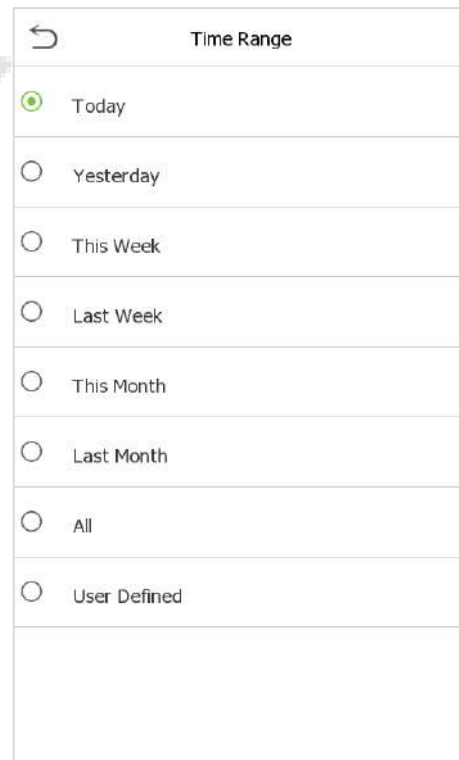
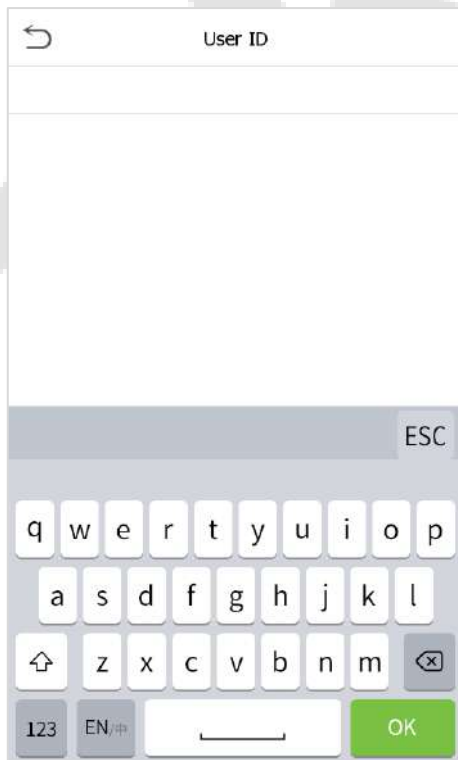

3. Once the log search succeeds. Tap the login highlighted in green to view its details.

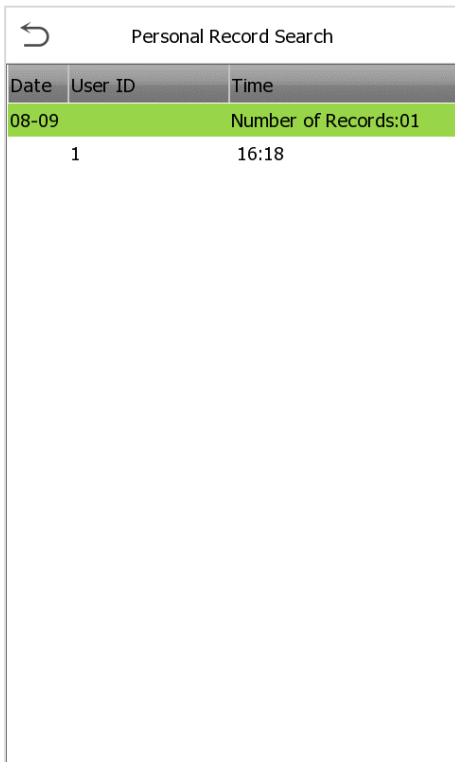

Personal Record Search

Date	User ID	Time
08-09		Number of Records:01
	1	16:18

4. The below figure shows the details of the selected log.

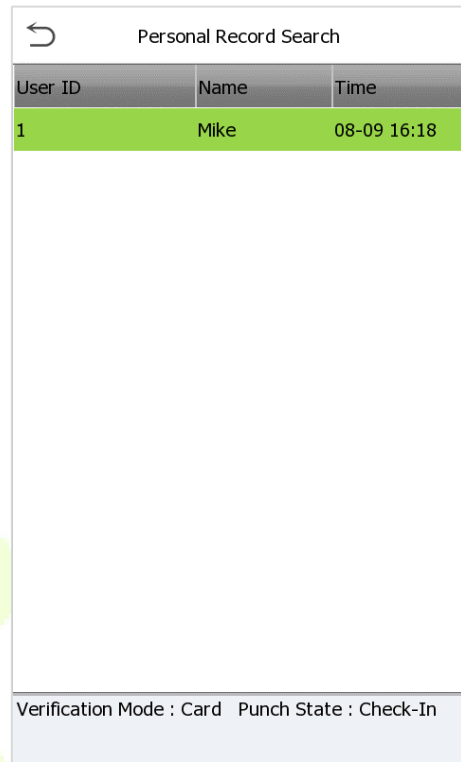

Personal Record Search

User ID	Name	Time
1	Mike	08-09 16:18

Verification Mode : Card Punch State : Check-In

12 Work Code★

Employees' salaries are subject to their attendance records. An employee can be engaged in more than one type of work which may vary with time. As the pay varies according to the work types, the FFR terminal provides a parameter to indicate the corresponding work type for every attendance record to facilitate rapid understanding of different attendance situations during the handling of attendance data.

Note: Only can use in the T&A PUSH, please refer to [6.5 Device Type Setting](#).

Tap **Work Code** on the **Main Menu** interface.

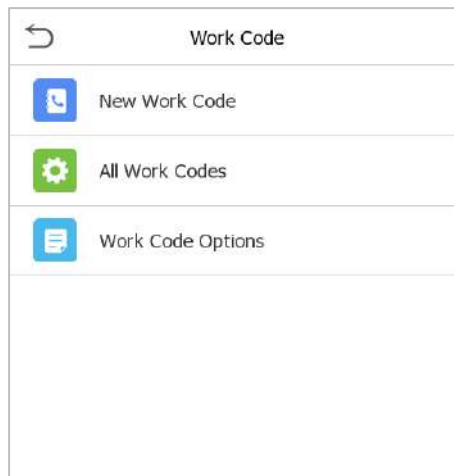

12.1 Add a Work Code

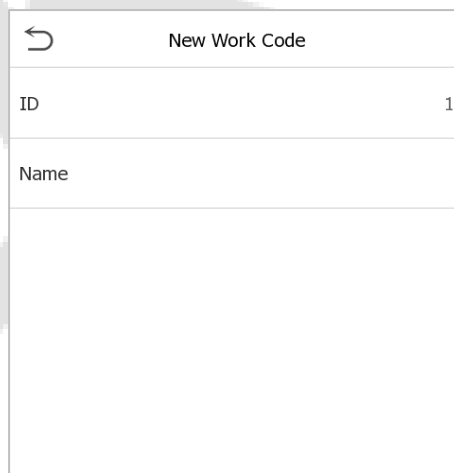

Function Description

Function Name	Description
ID	It is the digital code of the work code. Users may set a valid value between 1 and 99999999.
Name	It is the naming of the work code.

12.2 All Work Codes

You can view, edit and delete work codes in All Work Codes. The process of editing a work code is the same as adding a work code, except that the ID is not allowed to be modified.

All Work Codes	
1	1
2	2

12.3 Work Code Options

To set whether entering the work code is a must and whether the entered work code must exist during authentication.

Work Code Options	
Work Code Required	<input checked="" type="checkbox"/>
Input Screen Timeout(s)	5
Work Code Must Defined	<input checked="" type="checkbox"/>

In 1: N or 1:1 verification, the system will automatically pop up in the following window. Select the corresponding Word Code manually to verify successfully.

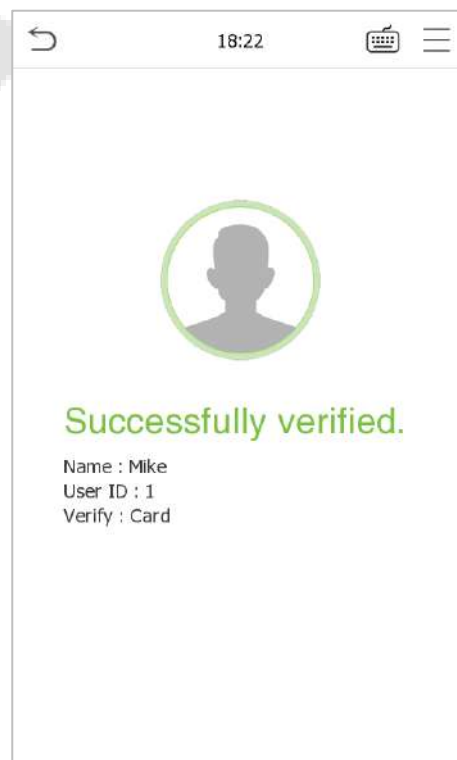
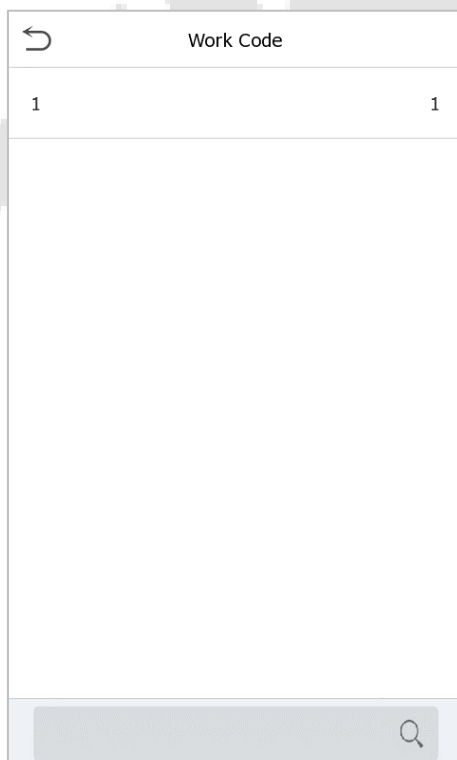

13 Autotest

On the **Main Menu**, tap **Autotest** to automatically test whether all modules in the device function properly, which include the LCD, Voice, Camera and Real-Time Clock (RTC).

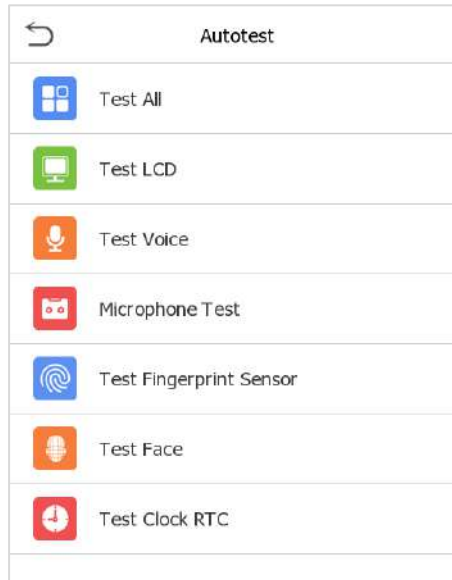

Function Description

Function Name	Description
Test All	To automatically test whether the LCD, Audio, Camera and RTC are normal.
Test LCD	To automatically test the display effect of LCD screen by displaying full-color, pure white, and pure black to check whether the screen displays colors normally.
Test Voice	To automatically test whether the audio files stored in the device are complete and the voice quality is good.
Microphone Test	Check whether the microphone is working by speaking to microphone and playing the microphone recording.
Test Fingerprint Sensor	To test the fingerprint sensor by pressing a finger on the scanner to check if the acquired fingerprint image is clear. When you are pressing a finger on the scanner, the fingerprint image will display on the screen.
Test Face	To test if the camera functions properly by checking the photos taken to see if they are clear enough.
Test Clock RTC	To test the RTC. The device tests whether the clock works normally and accurately with a stopwatch. Tap the screen to start counting and press it again to stop counting.

14 System Information

On the **Main Menu**, tap **System Info** to view the storage status, the version information of the device, and firmware information.

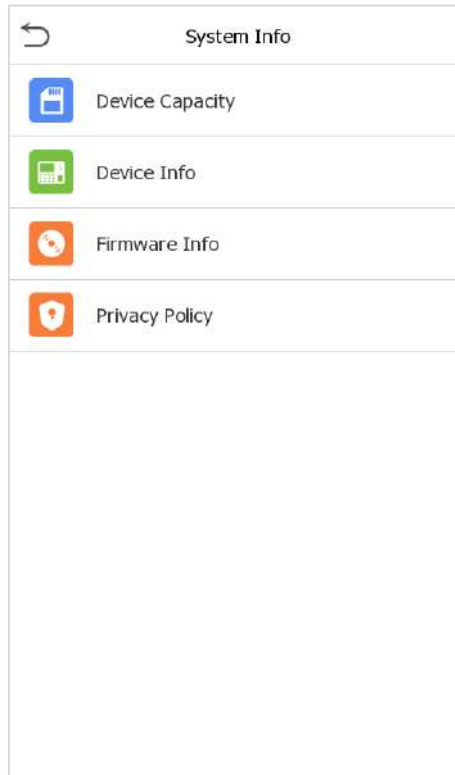

Function Description

Function Name	Description
Device Capacity	Displays the current device's user storage, password, face template and card storage, administrators, access records, attendance and blocklist photos, and user photos.
Device Info	Displays the device's name, serial number, MAC address, face template algorithm, version information, platform information, and manufacturer and manufacture date.
Firmware Info	Displays the firmware version and other version information of the device.
Privacy Policy	The privacy policy control will appear when the gadget turns on for the first time. After clicking " I have read it ," the customer can use the product regularly. Click System Info > Privacy Policy to view the content of the privacy policy. The privacy policy's content does not allow for U disc export. Note: The current privacy policy's text is only available in Simplified Chinese/ English. However, translation of other multi-language content is underway, with more iterations.

15 Connecting to ZKBio Zlink Web

Change the device communication protocol to BEST protocol, then the device can be managed by ZKBio Zlink, please refer to [6.5 Device Type Setting](#).

Users can use the created account to access ZKBio Zlink Web to connect devices, add new personnel, register the verification method of registered personnel, synchronize personnel to devices and query records.

15.1 Register Account

1. Access the ZKBio Zlink website (<http://zlink.minervaiot.com>).
2. If you do not have an account, please click **create account** to add a new account.

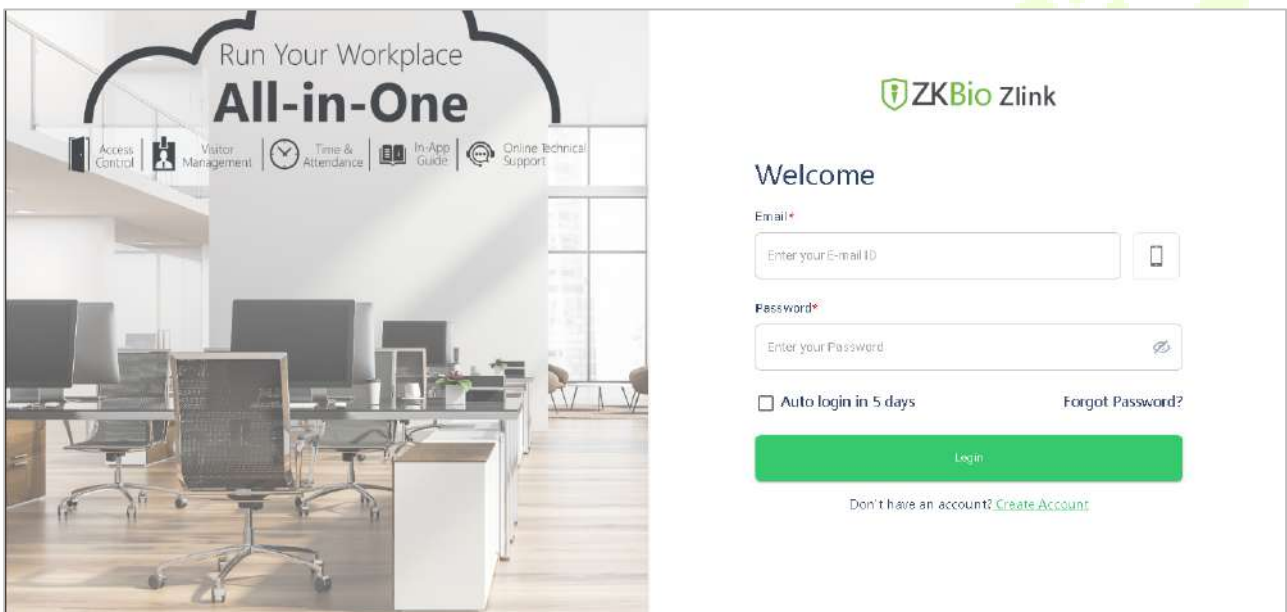

3. Read and agree to User Agreement and Privacy Policy, then click **Register**.

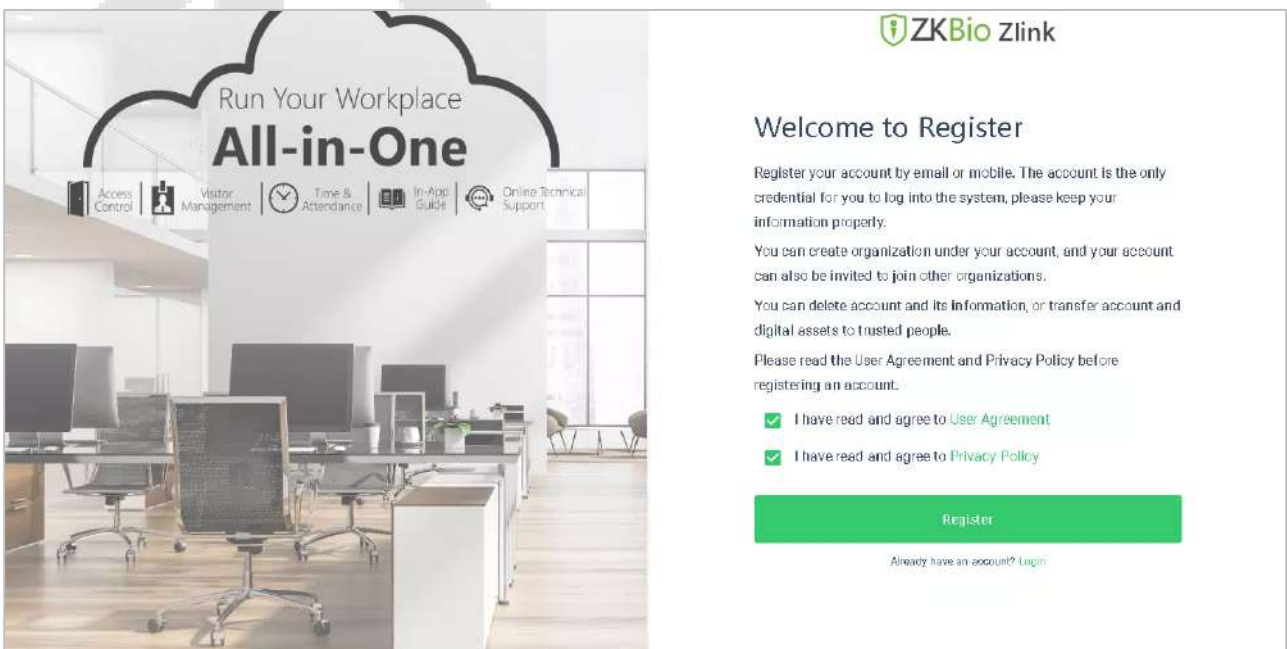

- 4. Enter user's information and set password, then click **Register**.

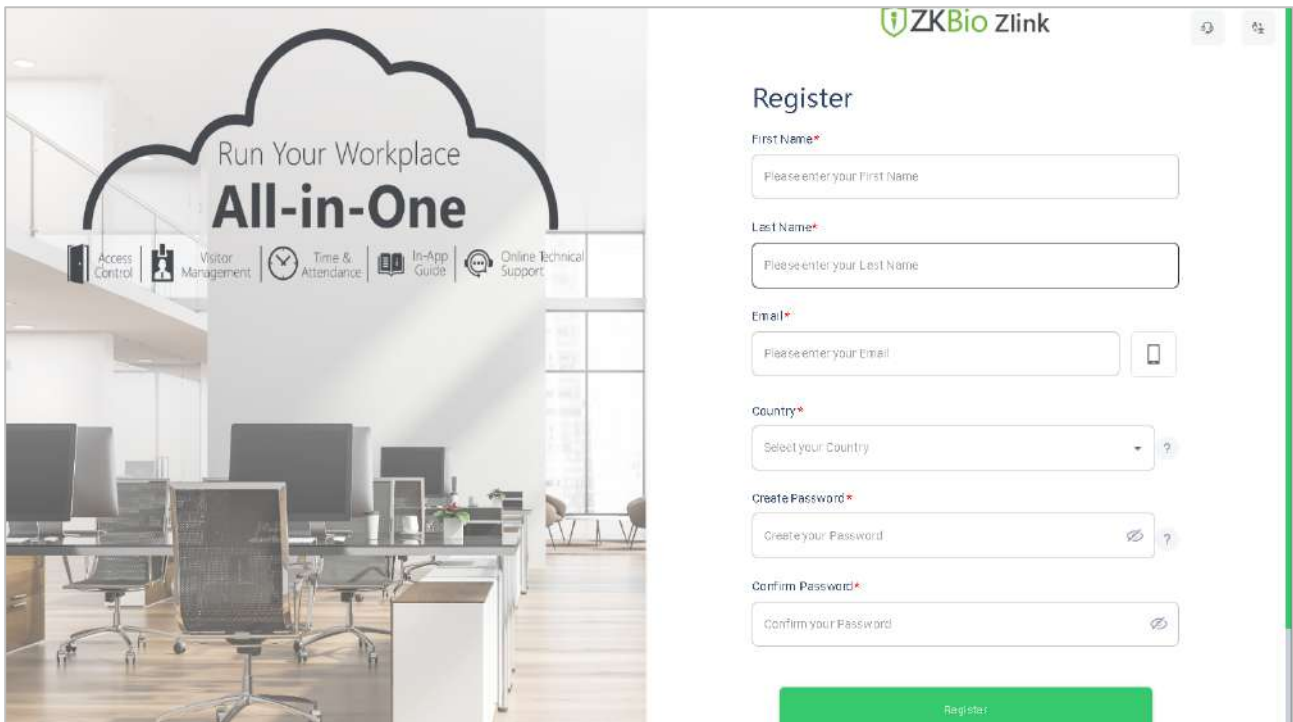

- 5. Set the organization's name and Organization code, click **Create**, then complete registration. If you do have an organization, please click **Select an Organization**.

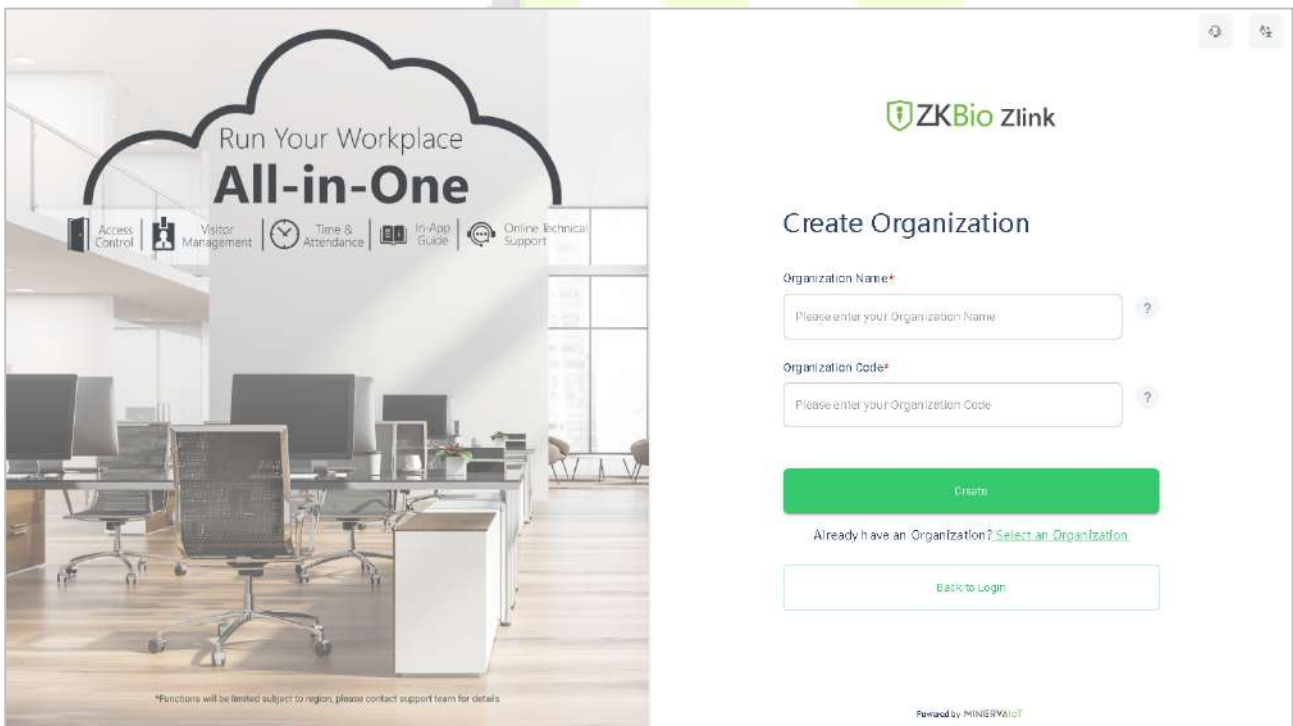

15.2 Add Device

15.2.1 Set Organization (Add Person)

1. Click **Me > Organization** on the main menu.

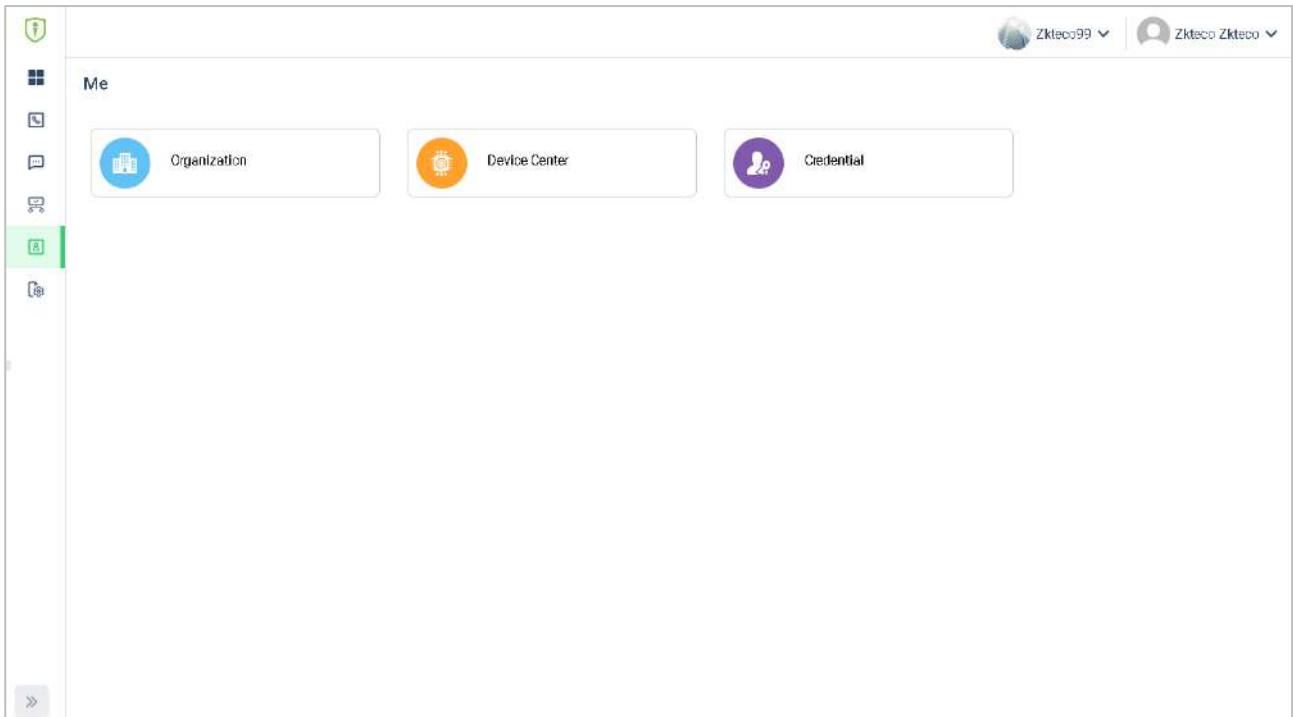

2. Click **Add** icon  to add a new person (Repeat adding the department, role and permission, job title, site list, and zone list).

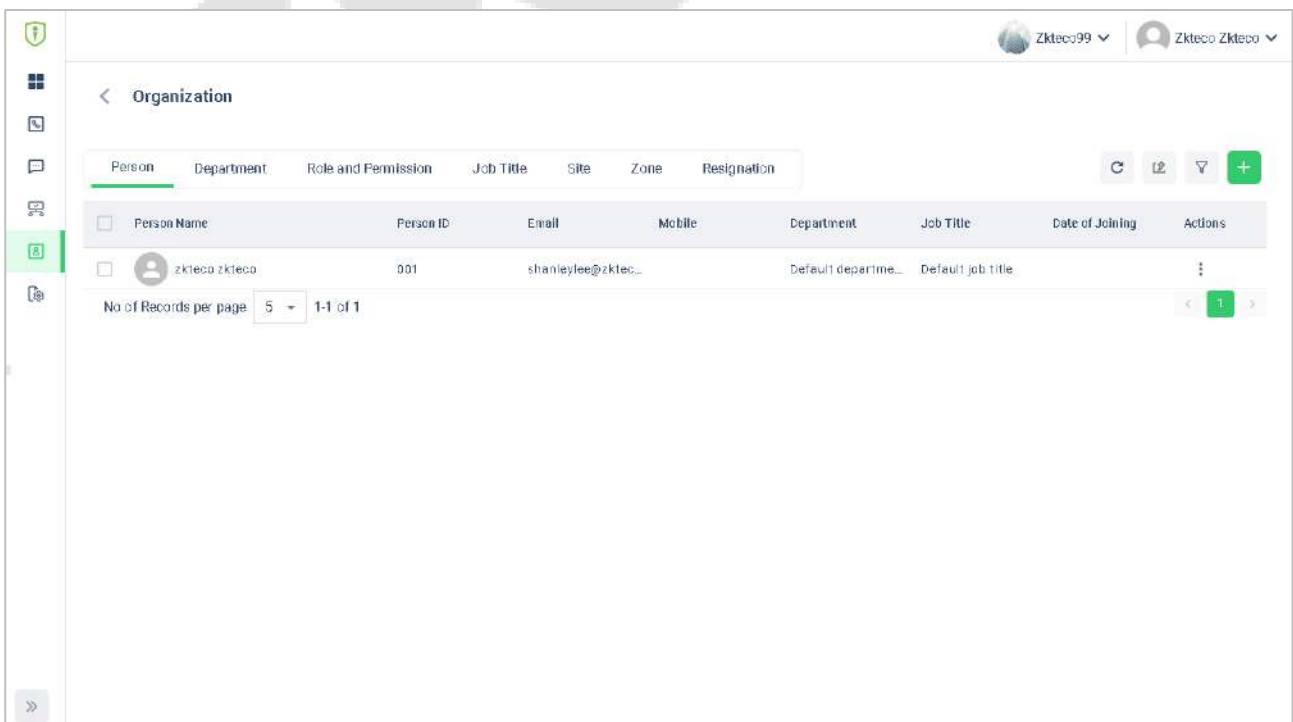

3. Enter the person’s details and click **Save** (Repeat adding the department, role and permission, job title, site list, and zone list).

15.2.2 Add Device

1. Tap **COMM. > Ethernet** in the main menu on the device to set the IP address and gateway of the device.

Ethernet	
IP Address	192.168.163.175
Subnet Mask	255.255.255.0
Gateway	192.168.163.1
DNS	114.114.114.114
TCP COMM.Port	4370
DHCP	<input type="checkbox"/>
Display in Status Bar	<input checked="" type="checkbox"/>

2. Click **Workshop > CloudACC** on the main menu to enter the **ZKBio Cloud Access** interface.

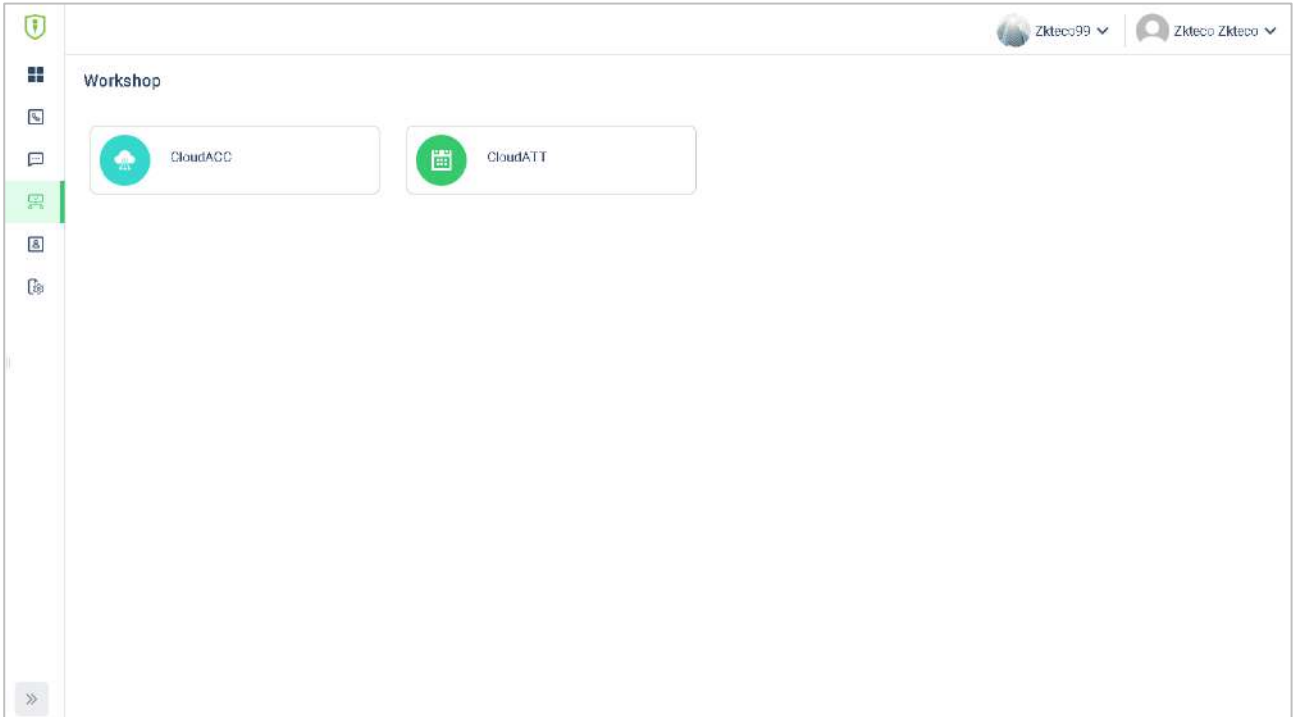

3. Click **Device Management > Device** to enter the **Device** interface in the **ZKBio Cloud Access**
4. Click **+Add Device** button to add a new device.
5. Read and check to the instructions, then click **Continue**.

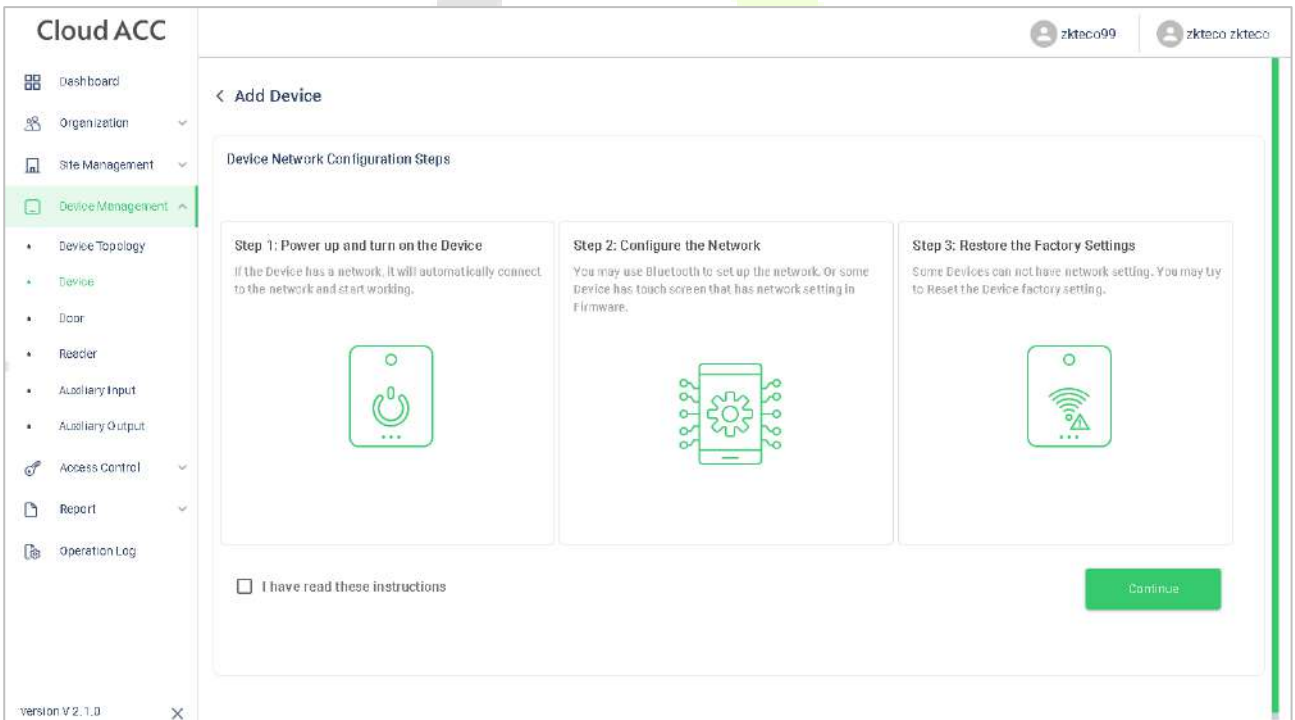

- 6. Enter the device’s serial number, then click **Add**. (Click **System Info > Device Info** on the device to view the serial number)

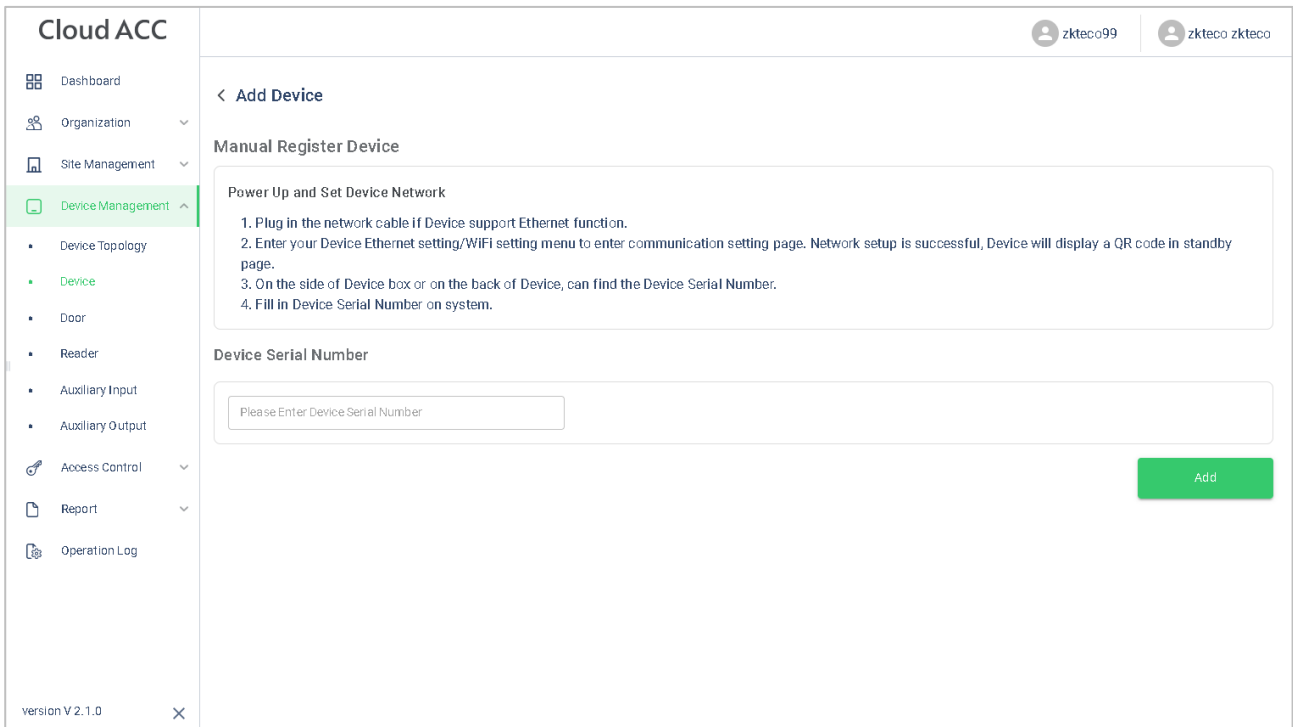

- 7. Choose a site and a zone, then click **Save** to finish.

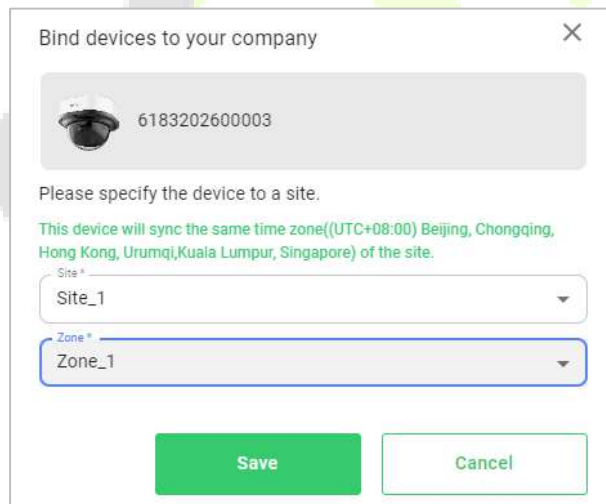



15.3 Time Slot

Time Slot is used to set the access time period for person or doors.

15.3.1 Set Time Slot

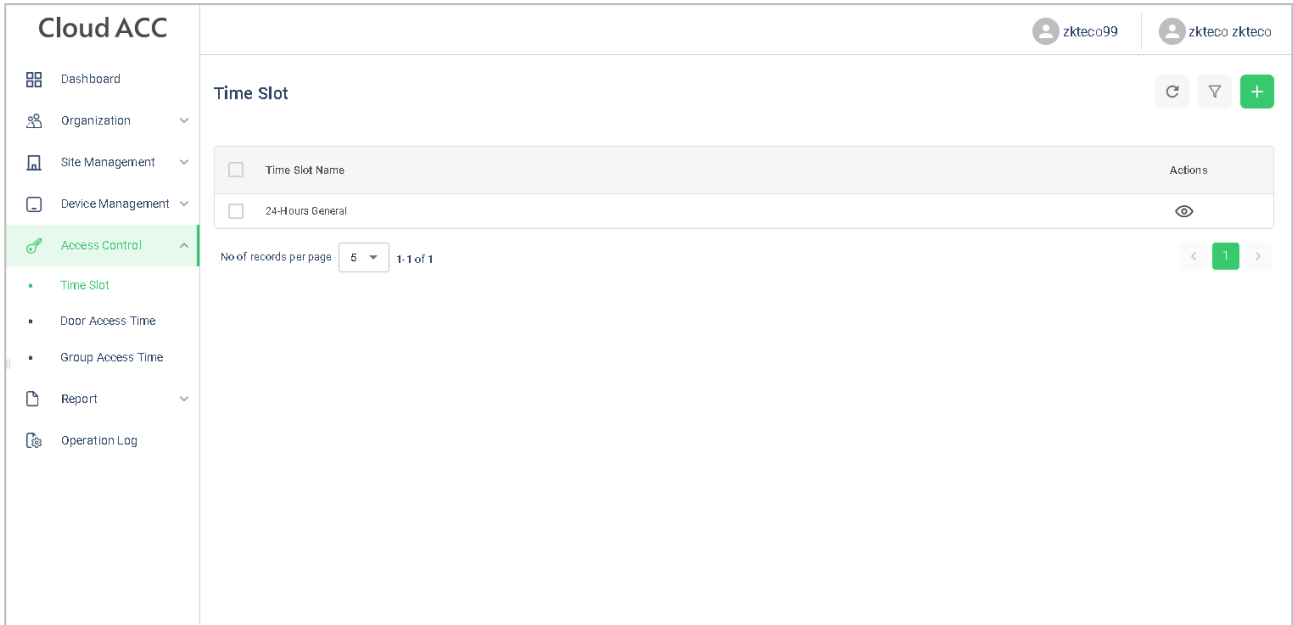
In **ZKBio Cloud Access** interface, click **Access Control > Time Slots** to set time slot.



Click **+Add Time slots** to add a new slot, or click  to modify an existing slot.

15.3.2 Set Door Access Time

In **ZKBio Cloud Access** interface, click **Access Control > Door Access Time** and click  to allocate a time slot to this door.

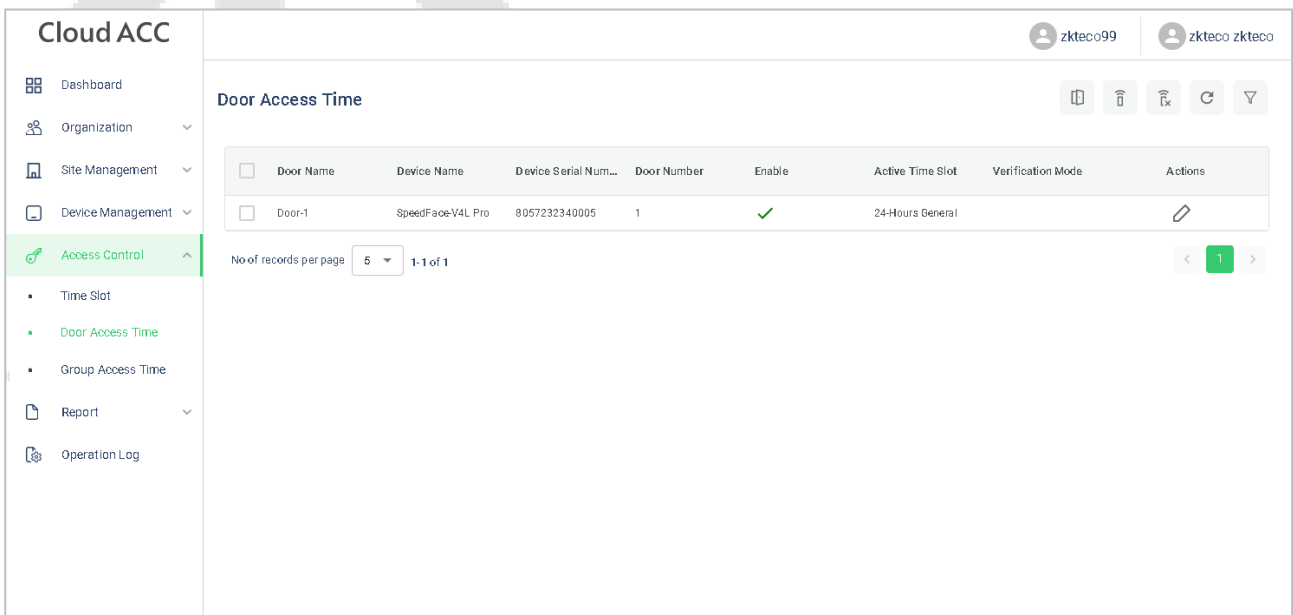

15.3.3 Set Group Access Time

You can set a group to control the access time of the person and the door at the same time.

In **ZKBio Cloud Access** interface, click **Access Control > Group Access Time**.

The screenshot displays the 'Group Access Time' configuration page in the ZKBio Cloud Access interface. The page title is 'Group Access Time'. On the left, there is a sidebar with navigation options: Dashboard, Organization, Site Management, Device Management, Access Control (highlighted), Report, and Operation Log. The main content area shows a table with the following data:

Name	Time Slot	Start Date and Time	End Date and Time	Actions
1	24-Hours General	10:37 01-08-2023	11:37 10-08-2023	Door Allocation, Person Allocation, Time Slot Allocation, Delete

Below the table, there is a pagination control showing 'No of records per page' set to 5, and '1-1 of 1'. The top right corner shows user profiles for 'zkteco99' and 'zkteco zkteco'. The bottom left corner indicates 'version V 2.1.0'.

Click **+ Add Group Access Time** to add a new group.

Click  to allocate doors to this group.

Click  to allocate person to this group.

Click  to allocate a time slot to this group.

Click  to delete this group.

15.4 Synchronize Person to Device

1. Click **Workshop > CloudACC** on the main menu to enter the **ZKBio Cloud Access** interface.

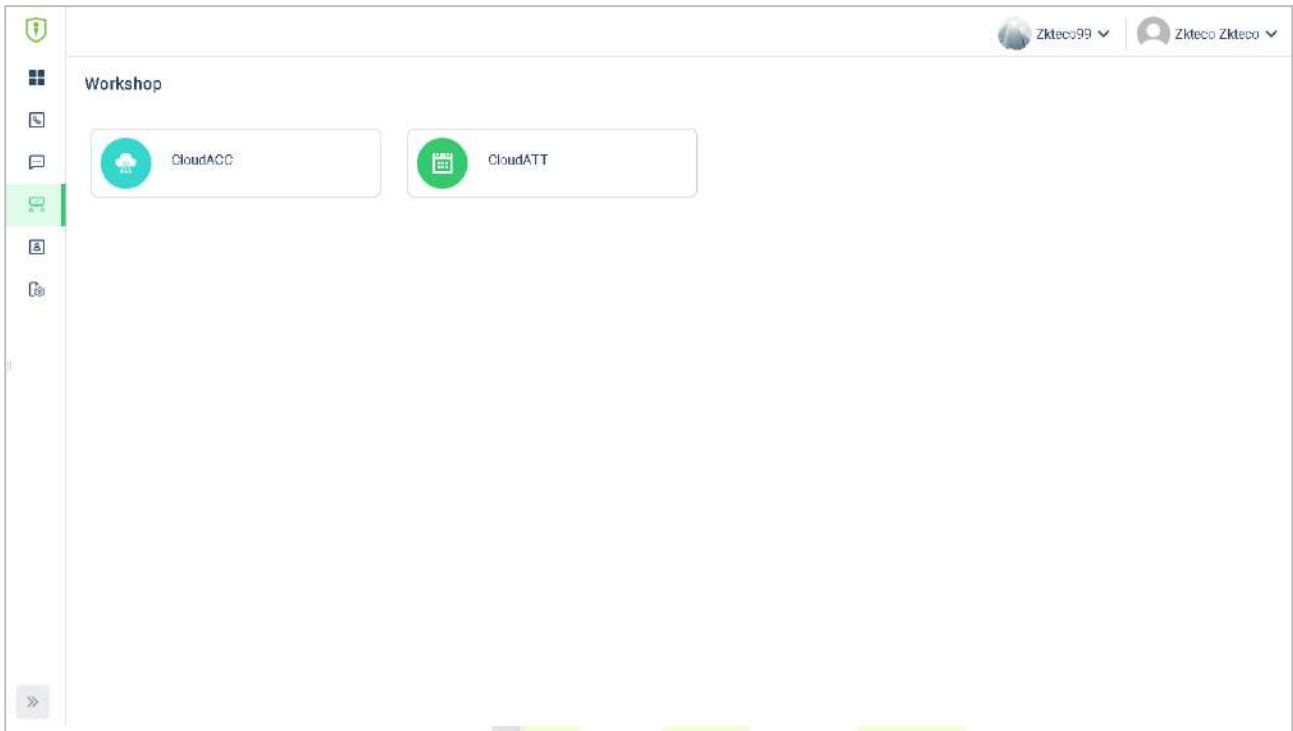

2. Click **Access Control > Group Access Time**.

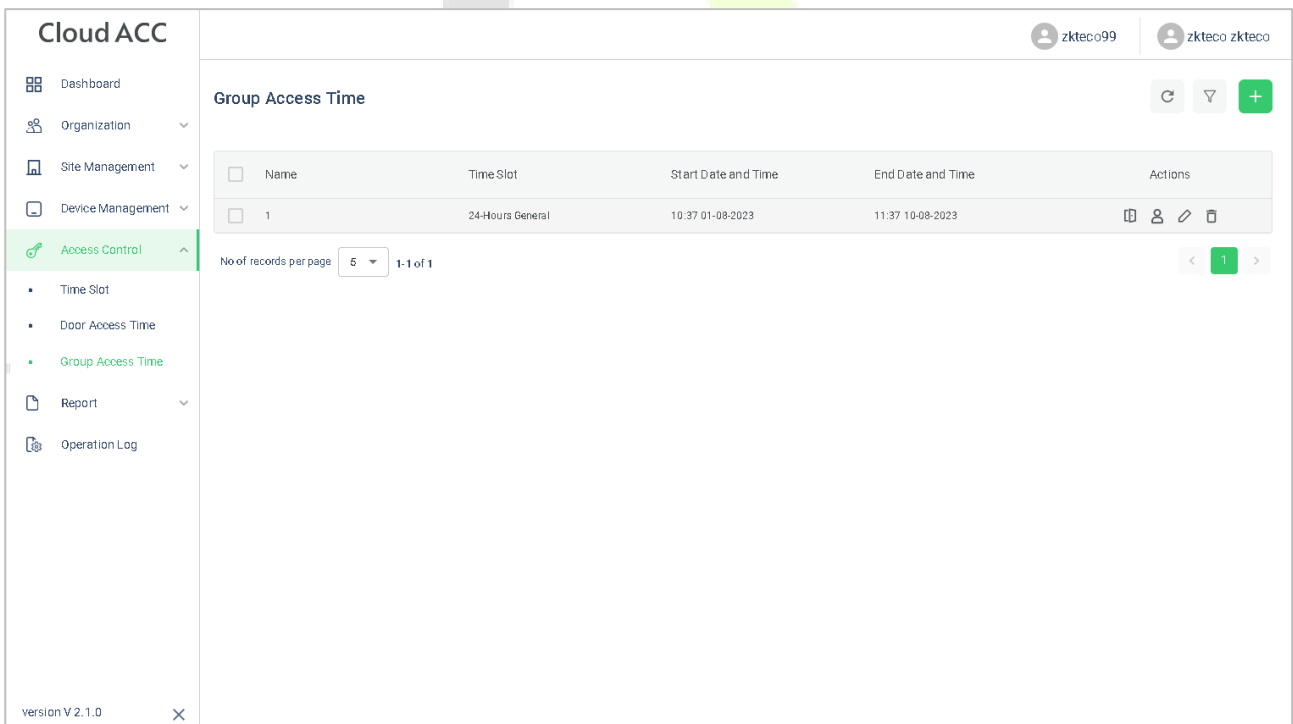

3. Click  >  to choose a device.

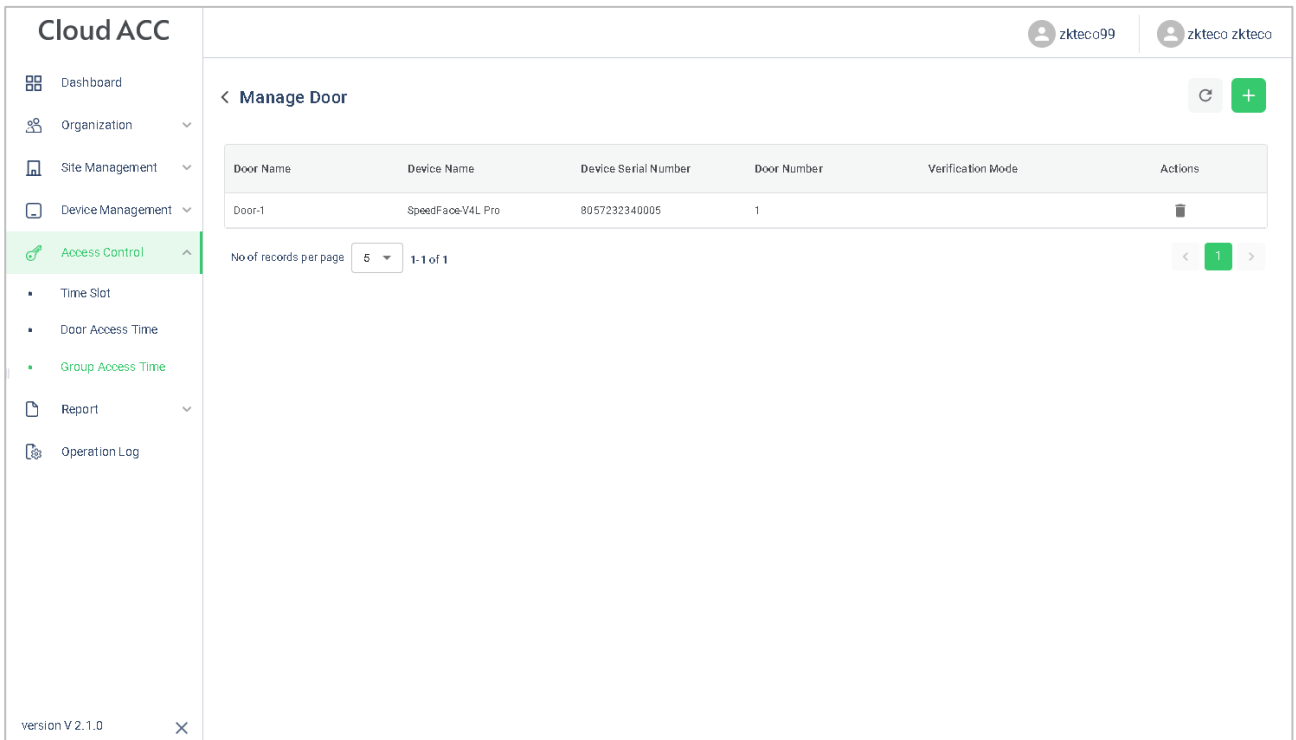

The screenshot shows the 'Manage Door' page in the Cloud ACC interface. The left sidebar contains navigation options: Dashboard, Organization, Site Management, Device Management, Access Control (highlighted), Time Slot, Door Access Time, Group Access Time, Report, and Operation Log. The main content area has a title '< Manage Door' and a refresh icon. Below the title is a table with columns: Door Name, Device Name, Device Serial Number, Door Number, Verification Mode, and Actions. The table contains one row: Door-1, SpeedFace-V4L Pro, 8057232340005, 1, and a trash icon. Below the table, there is a pagination control showing 'No of records per page' set to 5 and '1-1 of 1'. A version indicator 'version V 2.1.0' is at the bottom left.

Door Name	Device Name	Device Serial Number	Door Number	Verification Mode	Actions
Door-1	SpeedFace-V4L Pro	8057232340005	1		

4. Click  >  to allocate person to this device.

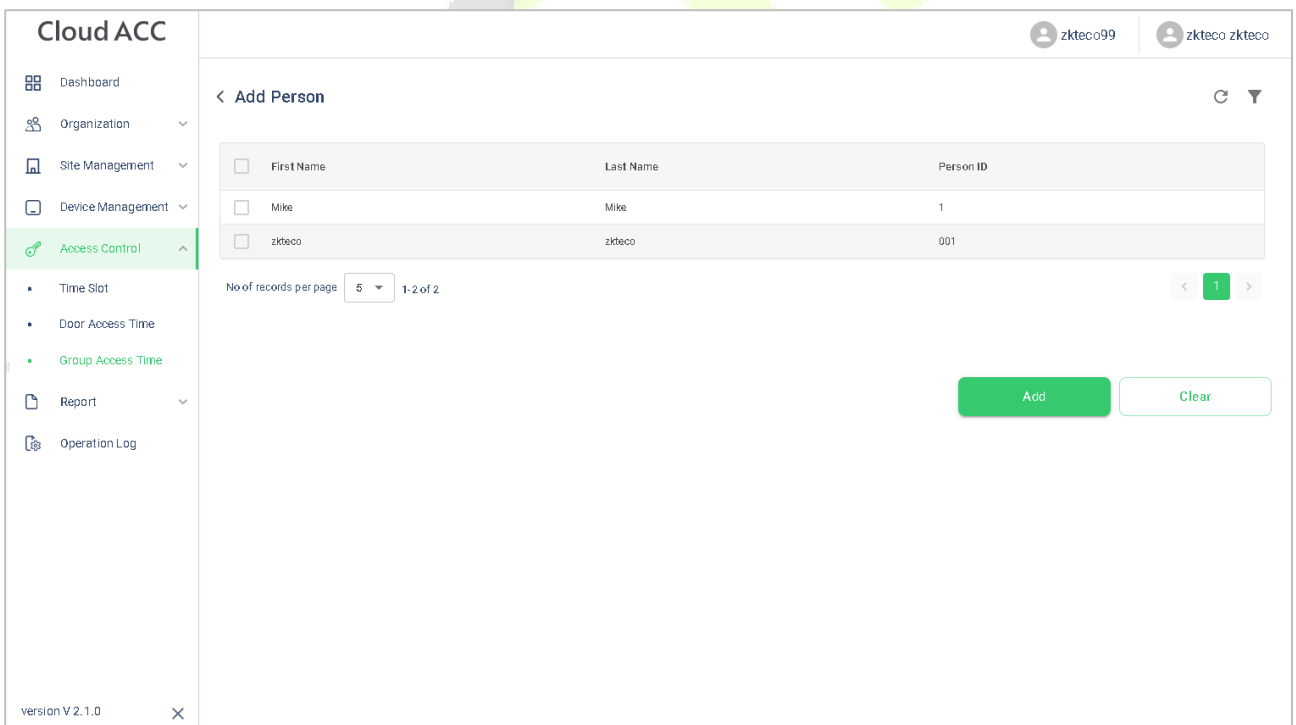

The screenshot shows the 'Add Person' page in the Cloud ACC interface. The left sidebar is the same as in the previous screenshot. The main content area has a title '< Add Person' and refresh and filter icons. Below the title is a table with columns: First Name, Last Name, and Person ID. The table contains two rows: Mike (Person ID 1) and zkteco (Person ID 001). Below the table, there is a pagination control showing 'No of records per page' set to 5 and '1-2 of 2'. At the bottom right, there are two buttons: 'Add' and 'Clear'. A version indicator 'version V 2.1.0' is at the bottom left.

First Name	Last Name	Person ID
<input type="checkbox"/>	Mike	1
<input type="checkbox"/>	zkteco	001

5. Click **Device Management > Device** to enter the **Device** interface.

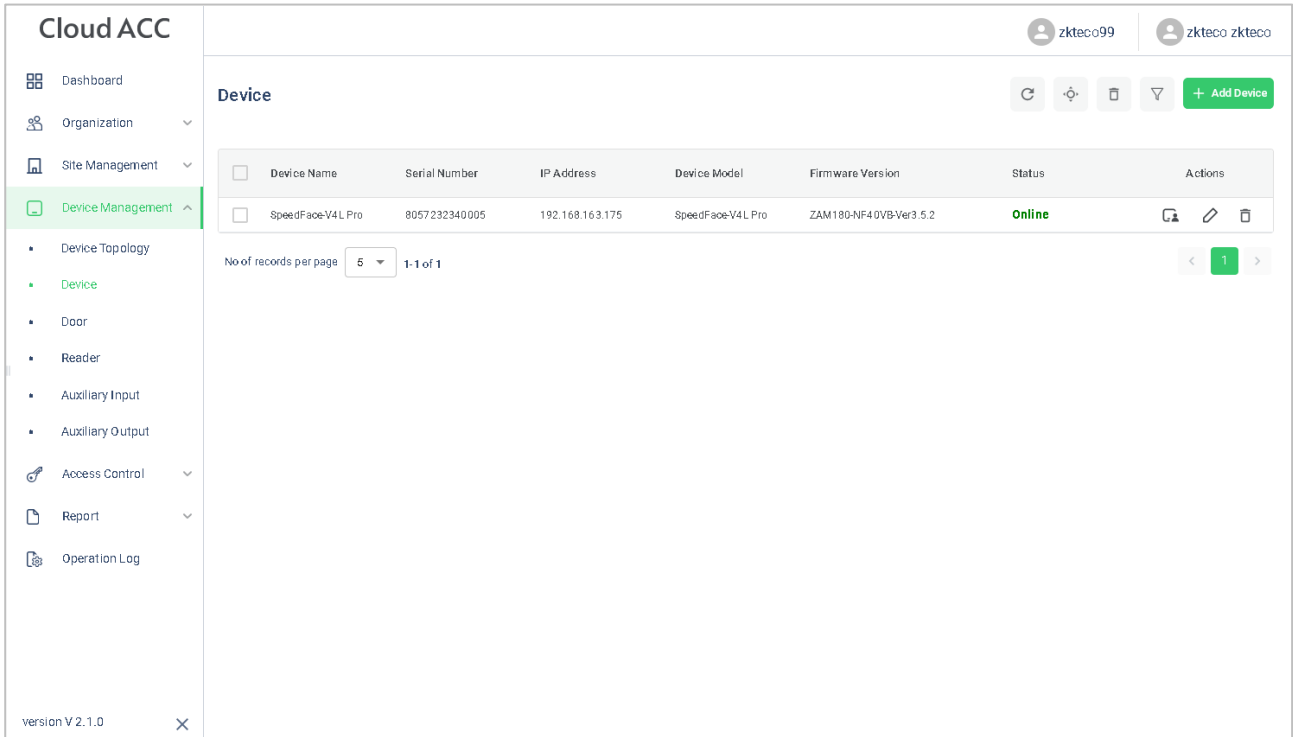

6. Choose a device and click **Persons in the Device** icon to view the person list.

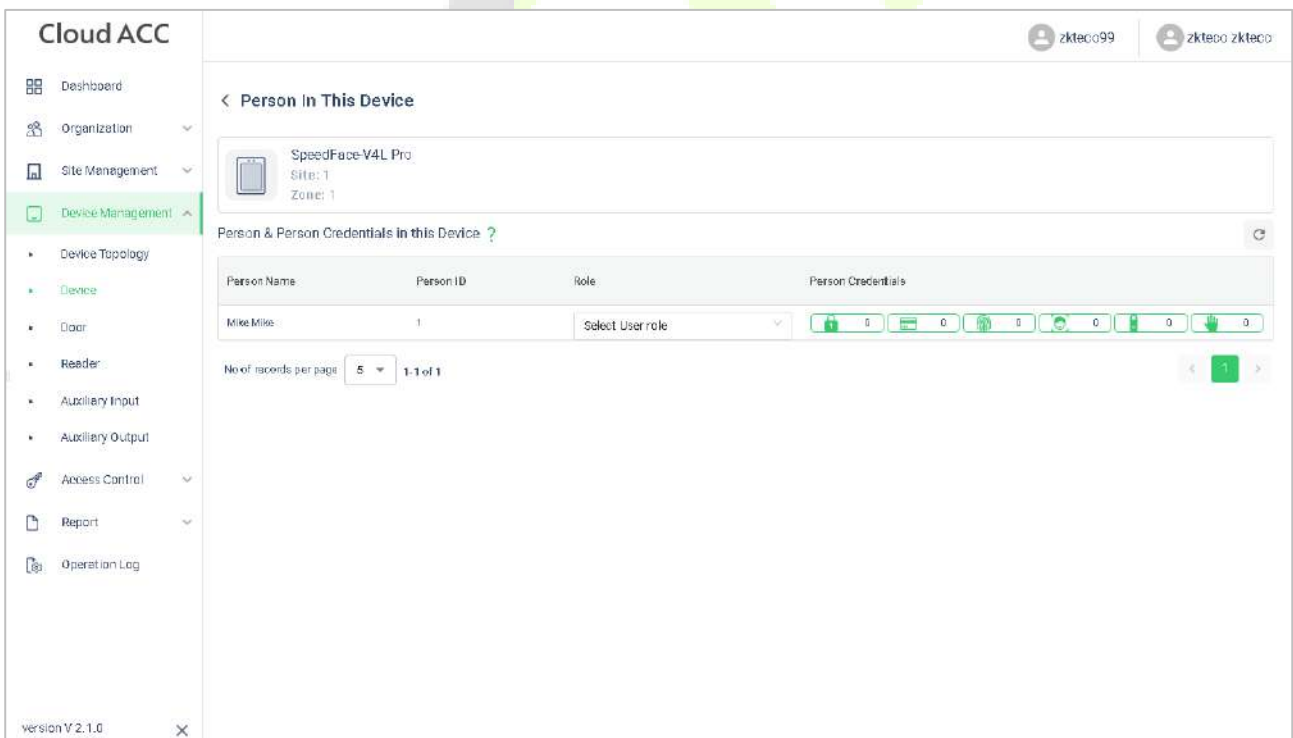

15.5 User Registration

15.5.1 Register a User ID and Name

Please refer to [14.2.1 Set Organization](#).

15.5.2 Setting the User Role

There are two types of user accounts: the **Normal User** and the **Super Admin**. If there is already a registered administrator, the normal users have no rights to manage the system and may only access authentication verifications. The administrator owns all management privileges.

1. Click **Device Management** > **Device** on **ZKBio Cloud Access** interface to enter the **Device** interface.
2. Choose a device and click **Persons in the Device** icon  to view the person list.

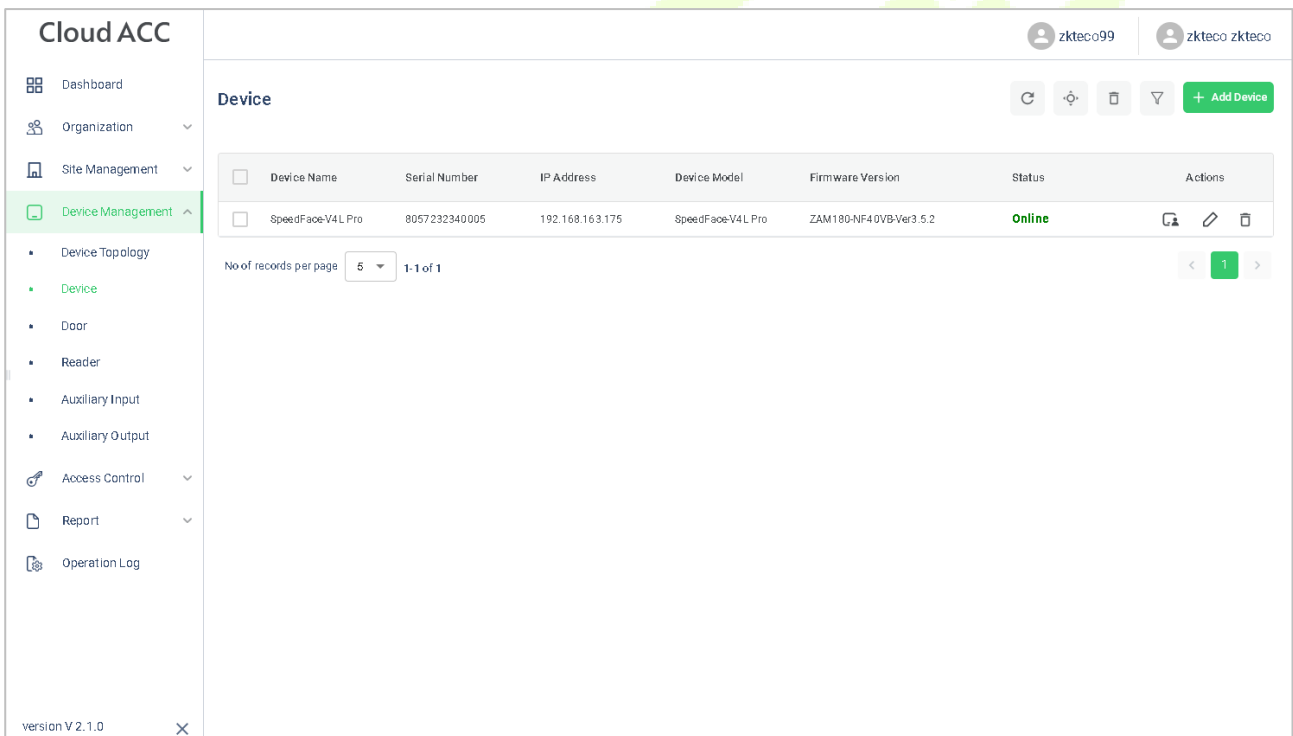

3. Choose the **Select User** role.

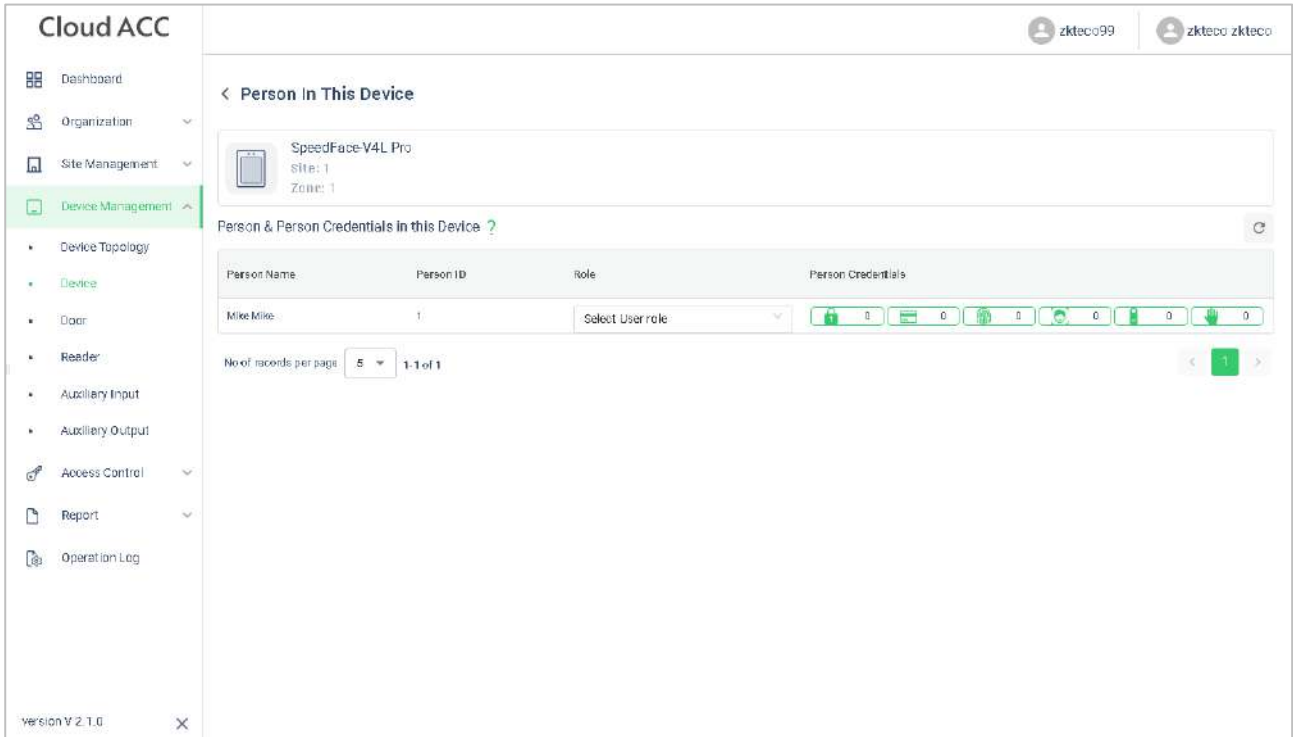

15.5.3 Register Fingerprint

1. Click **Device Management > Device** on **ZKBio Cloud Access** interface to enter the **Device** interface.
2. Choose a device and click **Persons in the Device** icon  to view the person list.

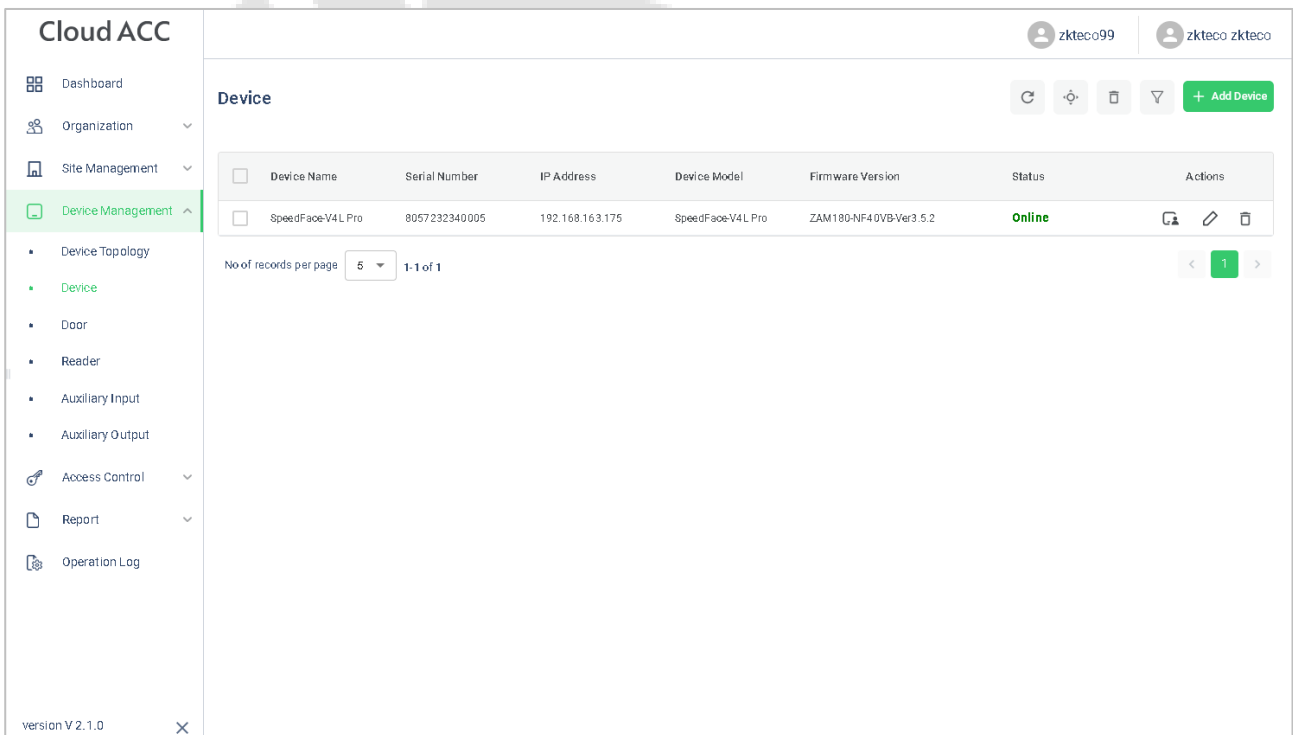

3. Click  icon to choose a finger, click **Submit**, then register fingerprint on the device.

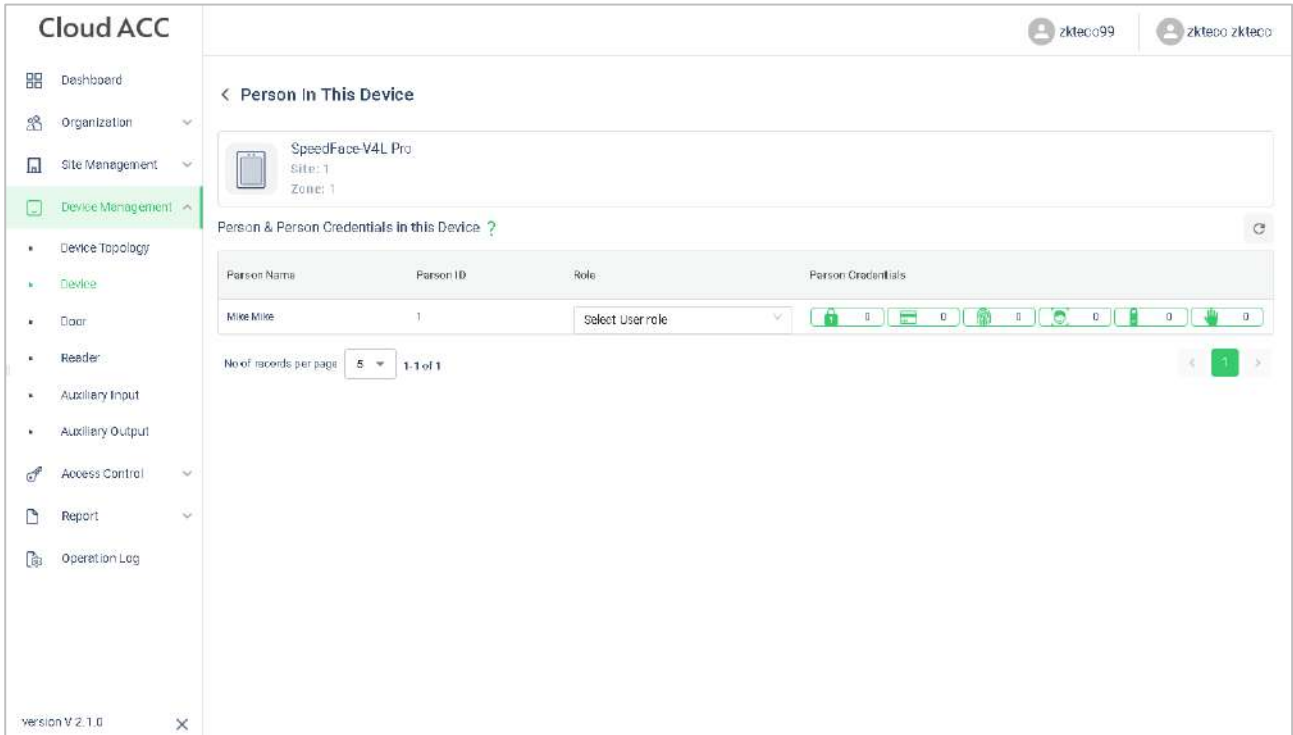

4. Press the same finger on the fingerprint reader three times. Green indicates that the fingerprint was enrolled successfully.

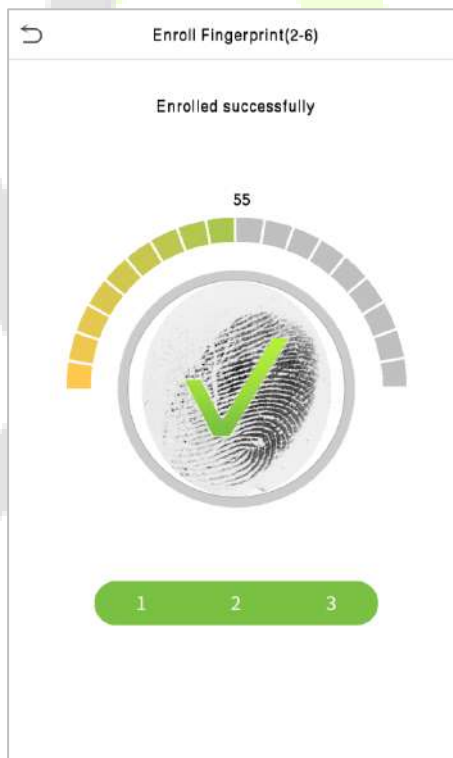

15.5.4 Register Face Template

1. Click **Device Management > Device** on **ZKBio Cloud Access** interface to enter the **Device** interface.
2. Choose a device and click **Persons in the Device** icon  to view the person list.

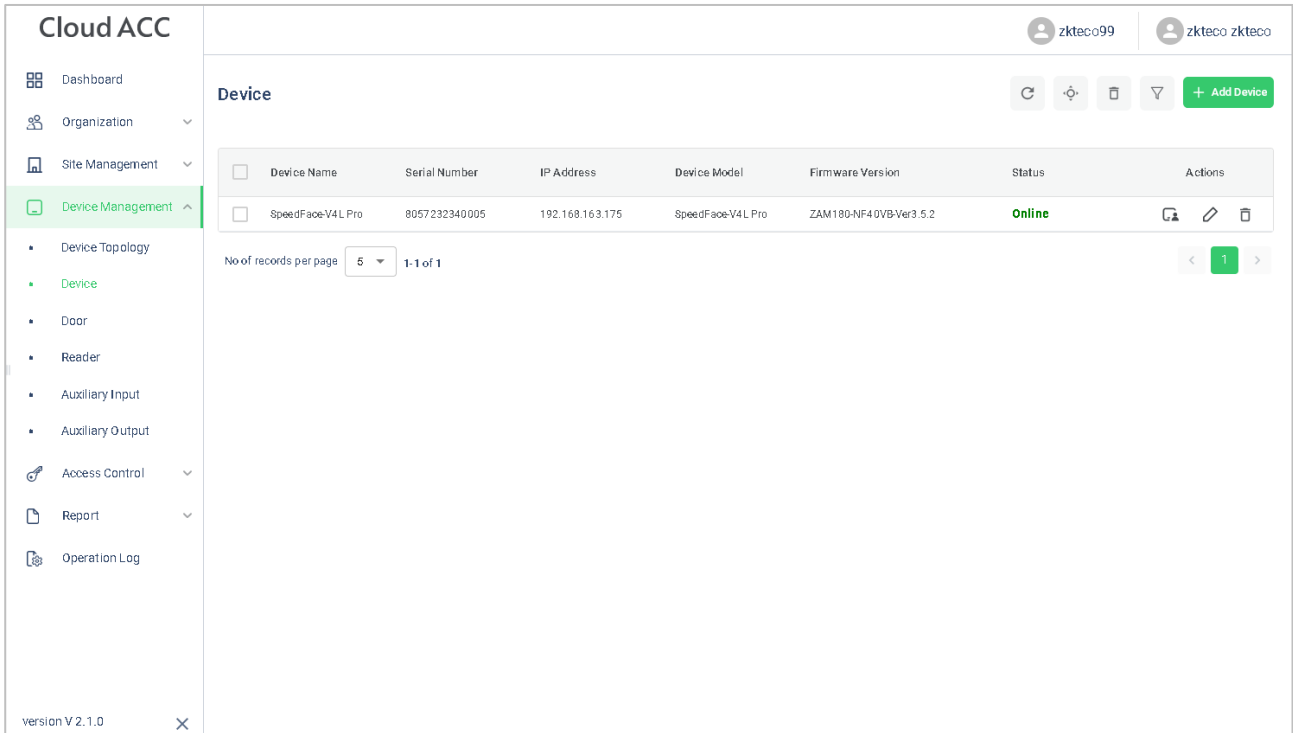

3. Click  icon to register face template on the device.

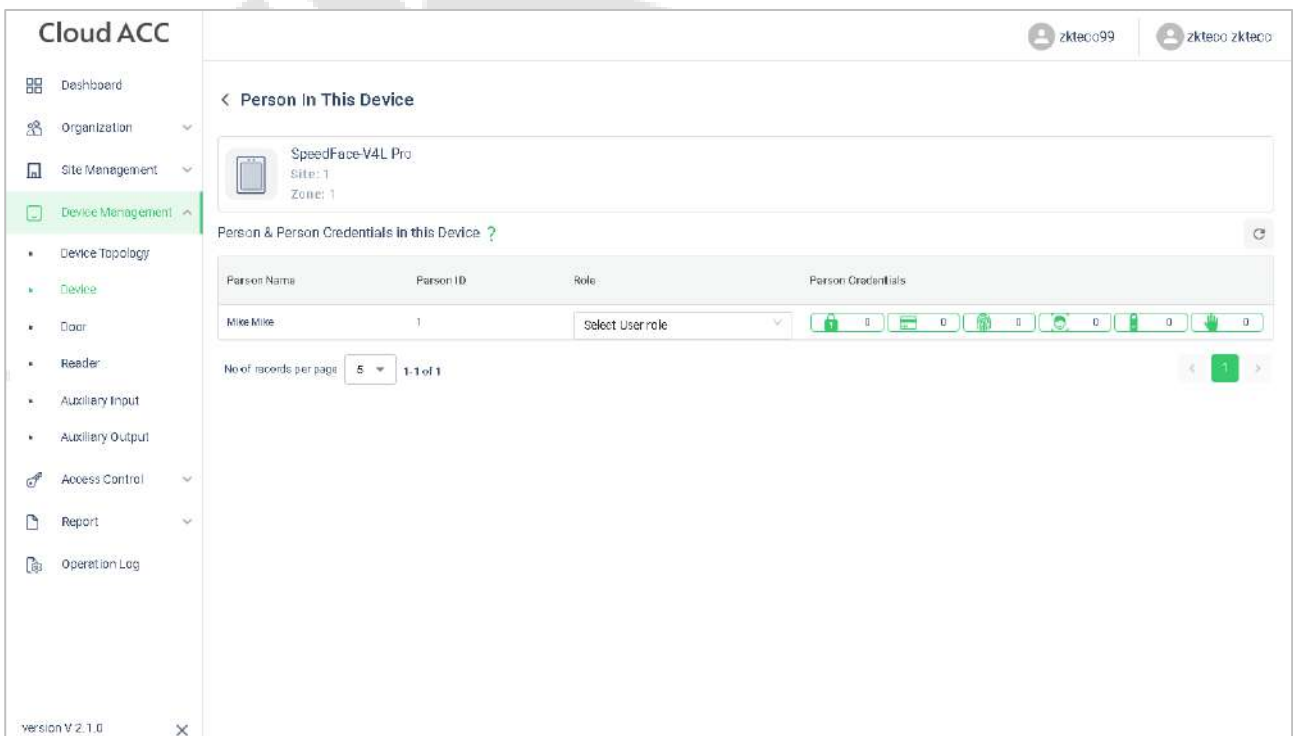

The registration interface is as follows:



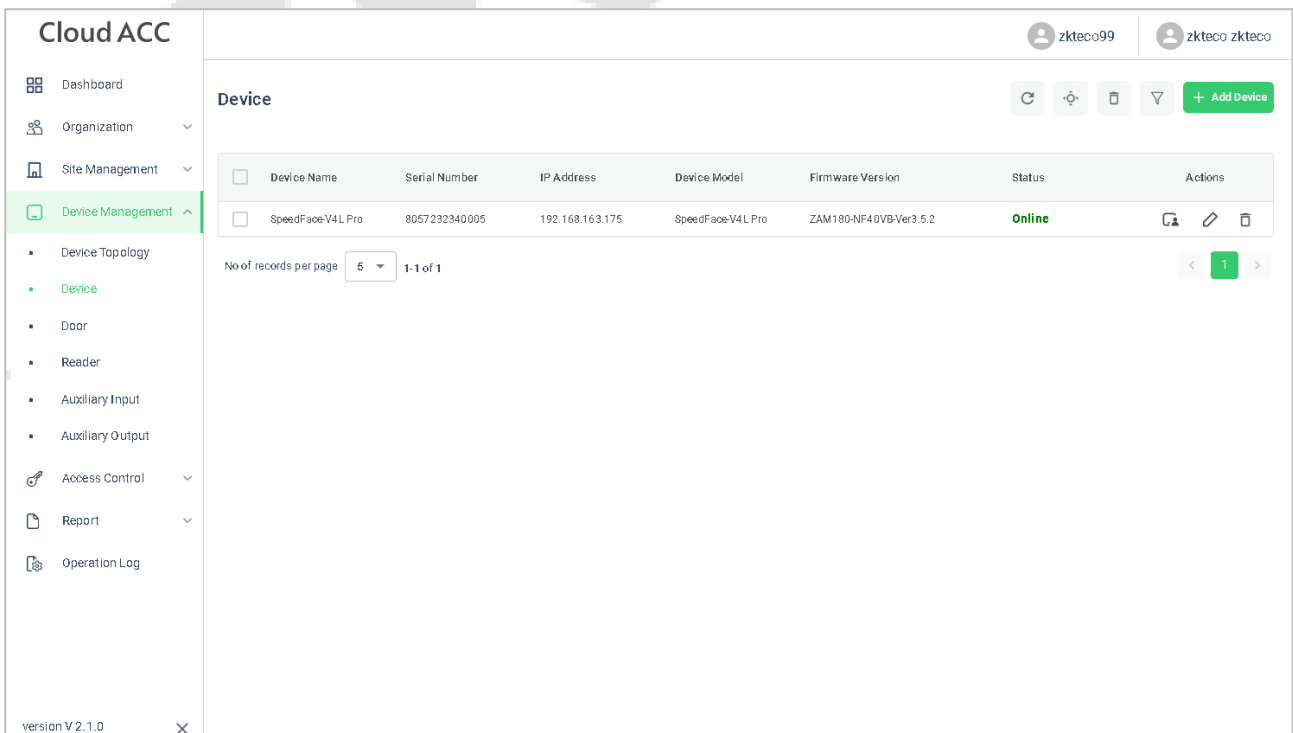

15.5.5 Register Password

1. Click **Device Management** > **Device** on **ZKBio Cloud Access** interface to enter the **Device** interface.
2. Choose a device and click **Persons in the Device** icon  to view the person list.



The screenshot shows the Cloud ACC web interface. On the left is a navigation menu with 'Device Management' selected. The main content area is titled 'Device' and contains a table with the following data:

<input type="checkbox"/>	Device Name	Serial Number	IP Address	Device Model	Firmware Version	Status	Actions
<input type="checkbox"/>	SpeedFace-V4L Pro	8057232340005	192.168.163.175	SpeedFace-V4L Pro	ZAM180-NF4 0VB-Ver3.5.2	Online	  

Below the table, there is a pagination control showing 'No of records per page' set to 5 and '1-1 of 1' records. A green 'Add Device' button is located in the top right corner of the device list area.

3. Click  icon to register password on the device.

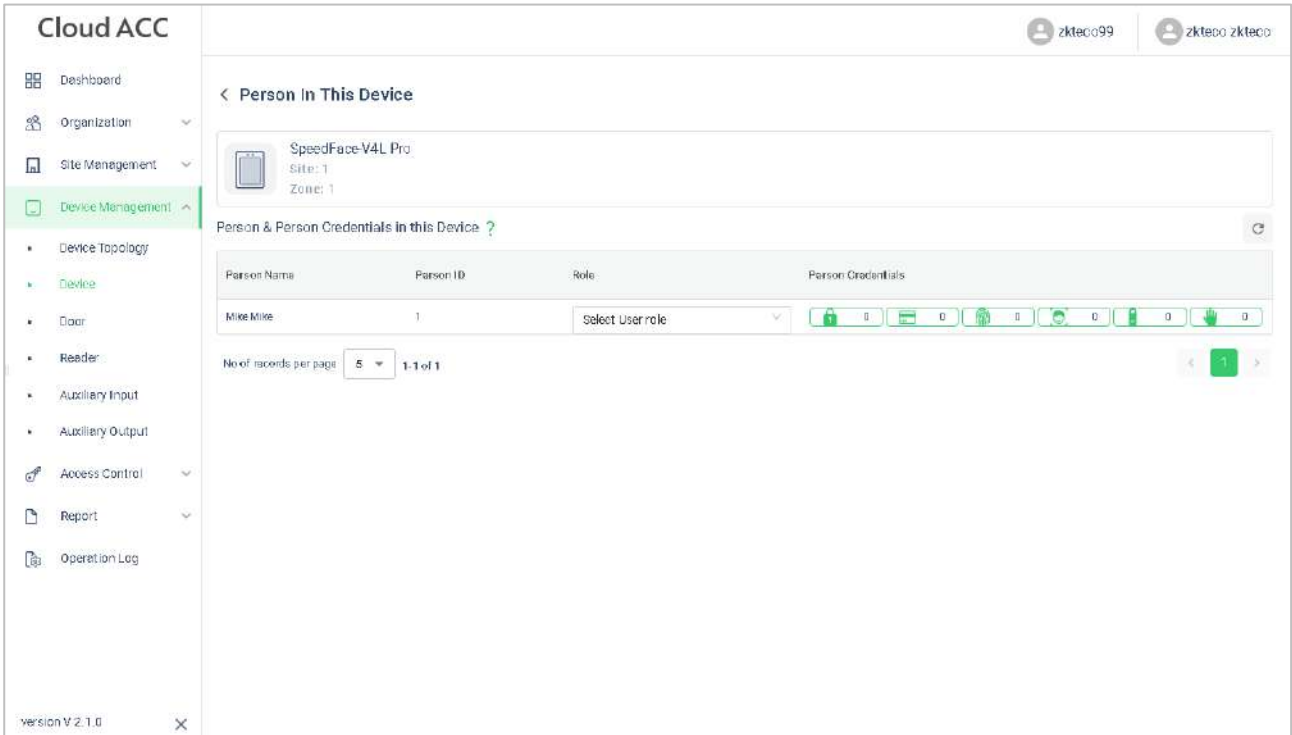

The registration interface is as follows:

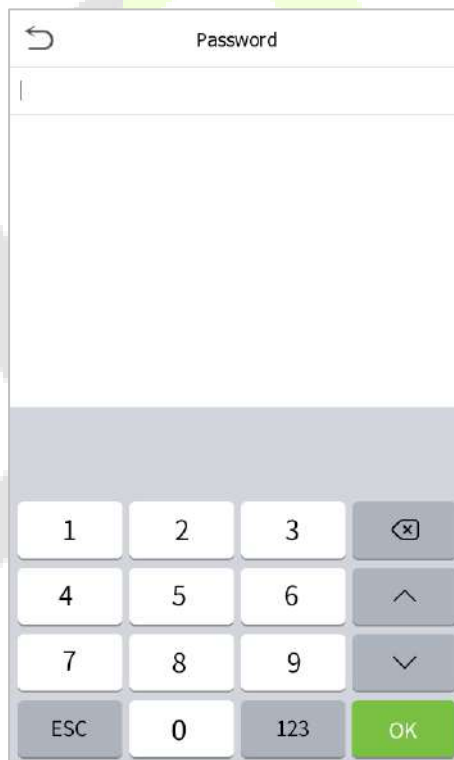

Note: The password may contain one to eight digits by default.

15.5.6 Register Card

1. Click **Device Management > Device** on **ZKBio Cloud Access** interface to enter the **Device** interface.
2. Choose a device and click **Persons in the Device** icon  to view the person list.

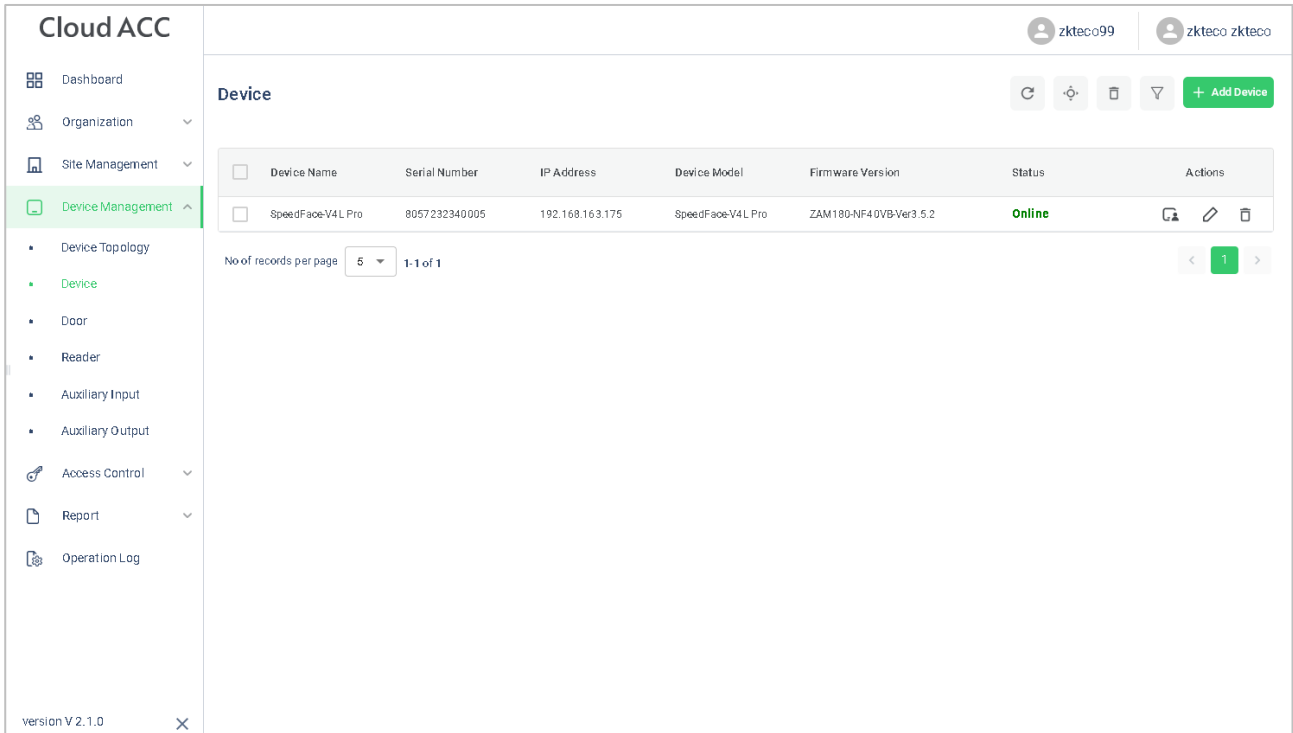

3. Click  icon to register password on the device.

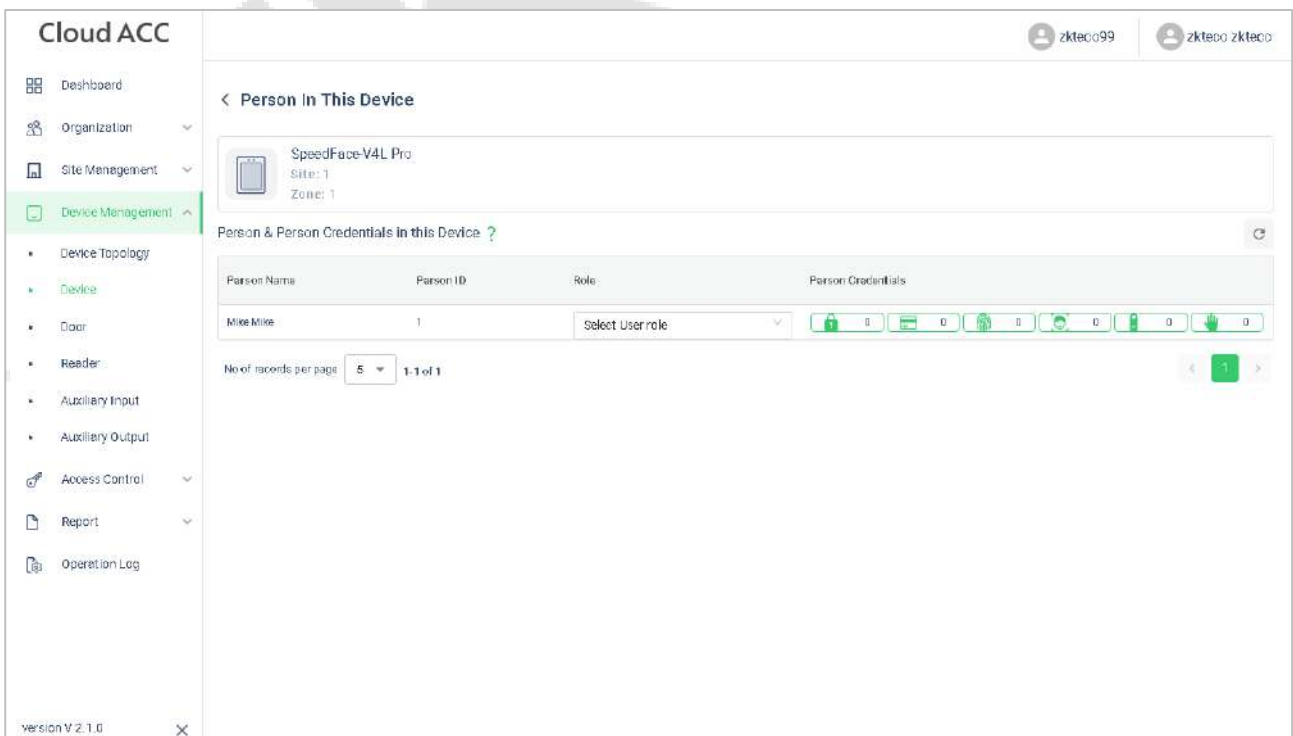

The registration interface is as follows:

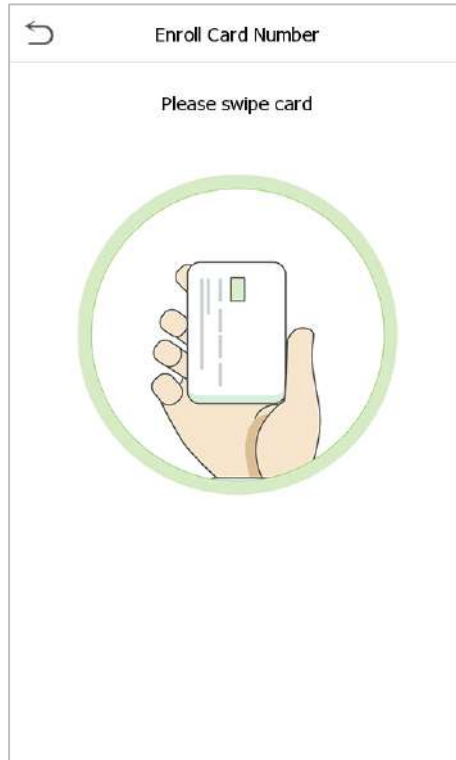

15.6 Data Search

15.6.1 Dashboard

In **ZKBio Cloud Access** interface, click **Dashboard** to check the sites, devices, doors, person of this application, events overview graph, and sites overview map.

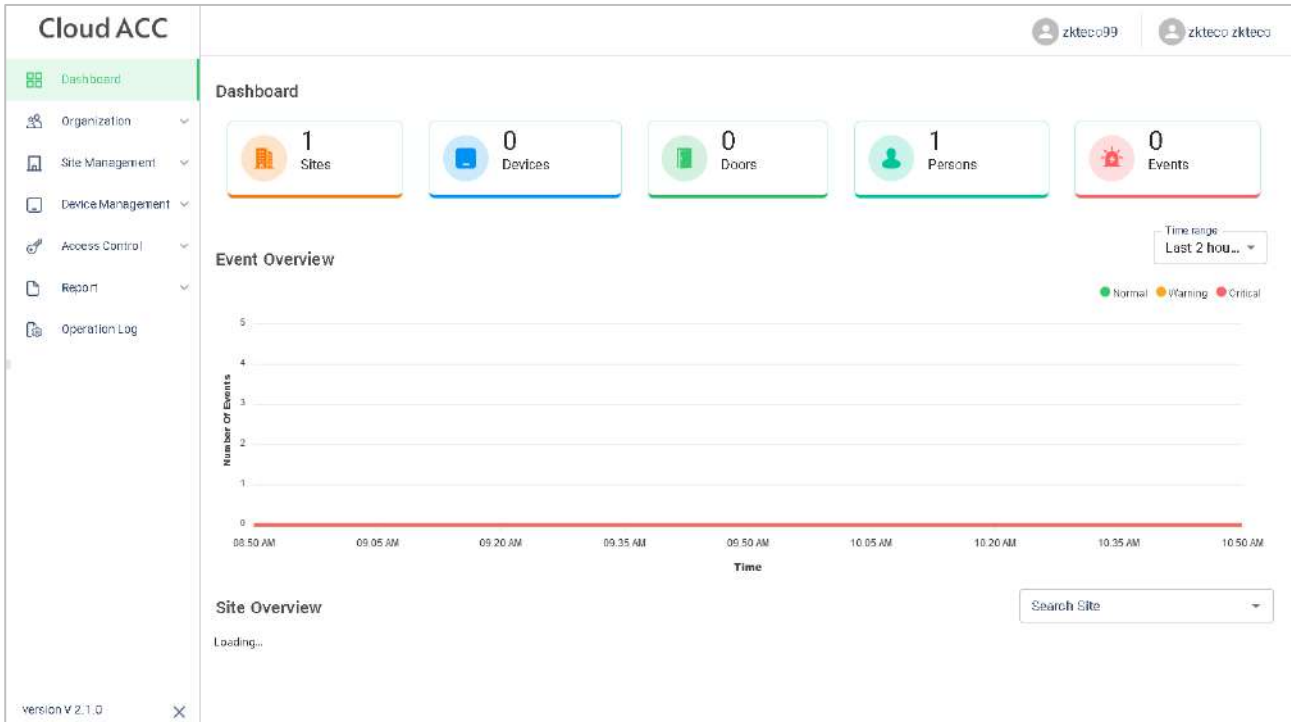

15.6.2 Event Report

In **ZKBio Cloud Access** interface, click **Report > Events** to check the specific information of all devices' events.

Cloud ACC zkteco99 zkteco zkteco

Events Refresh Filter Print

Person ID	Person Name	Device Name	Device Serial Number	Event Time	Event Address	Event Name	Verification Mode
		SpeedFace-V4L ...	8057232340005	2023-08-11 10:4...	1		
		SpeedFace-V4L ...	8057232340005	2023-08-11 10:4...	1		
10220		SpeedFace-V4L ...	8057232340005	2023-08-11 10:4...	1		
			8057232340005	2023-08-11 10:3...	1		
			8057232340005	2023-08-11 10:3...	1		

No of records per page 5 1-5 of 12 < 1 2 3 >

16 Connecting to ZKBio Zlink App

Change the device communication protocol to BEST protocol, then the device can be managed by ZKBio Zlink, please refer to [6.5 Device Type Setting](#).

Users can use the created account to access ZKBio Zlink App to connect devices, unlock the device remotely and query records.

16.1 Register Account

1. Search for the ZKBio Zlink App in Apple App Store or Google Play Store and download the App to your smartphone.
2. Open the ZKBio Zlink App and if you do not have an account, please click **create account** to add a new account.
3. Read and agree to User Agreement and Privacy Policy, then click **Register**.
4. Enter user's information and set password, then click **Register**.

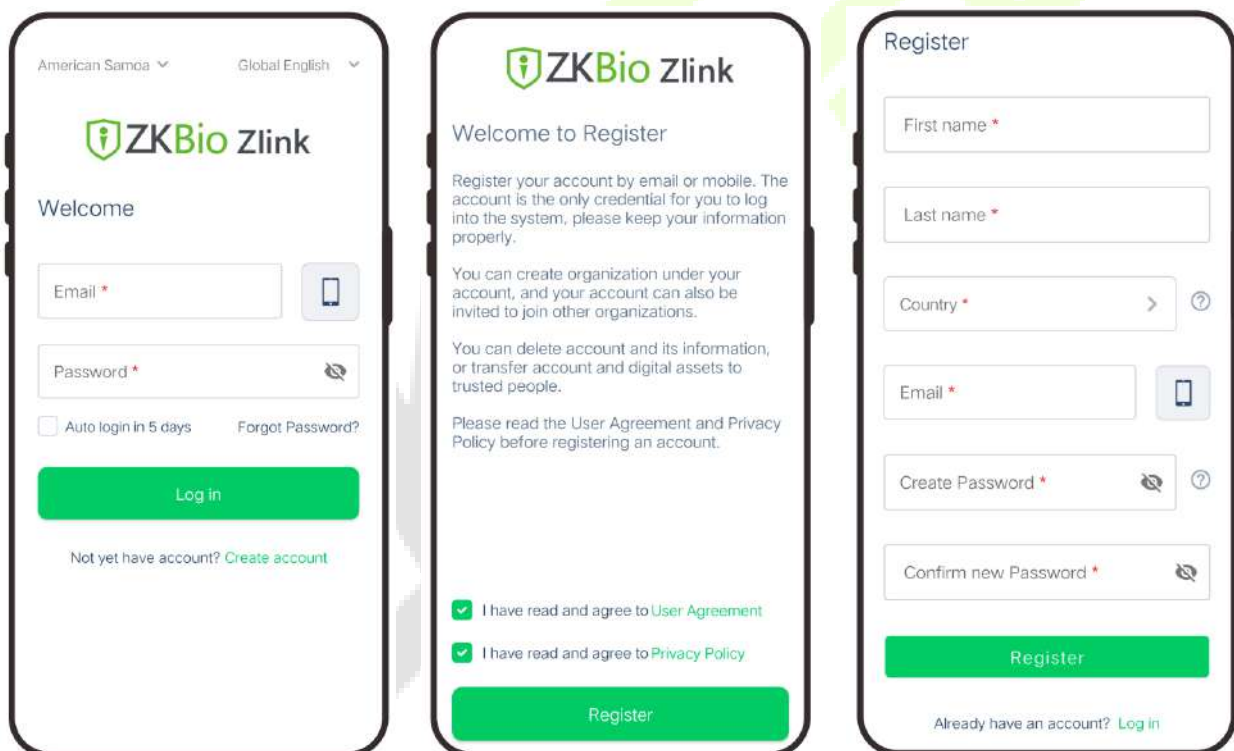

- Choose an organization, click **Enter**, then complete registration. If you do not have an organization, please click **Create one**.

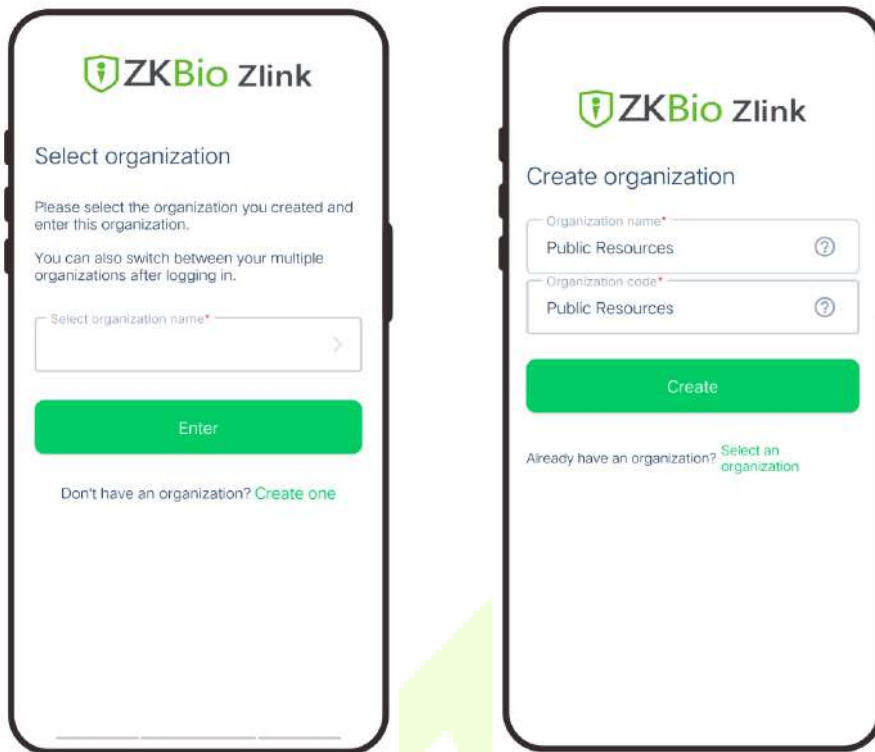

16.2 Add Person

- Click **Me > Organization > Person** on the main menu.
- Click **+** icon to add a new person. Enter the information, and click **Save**.

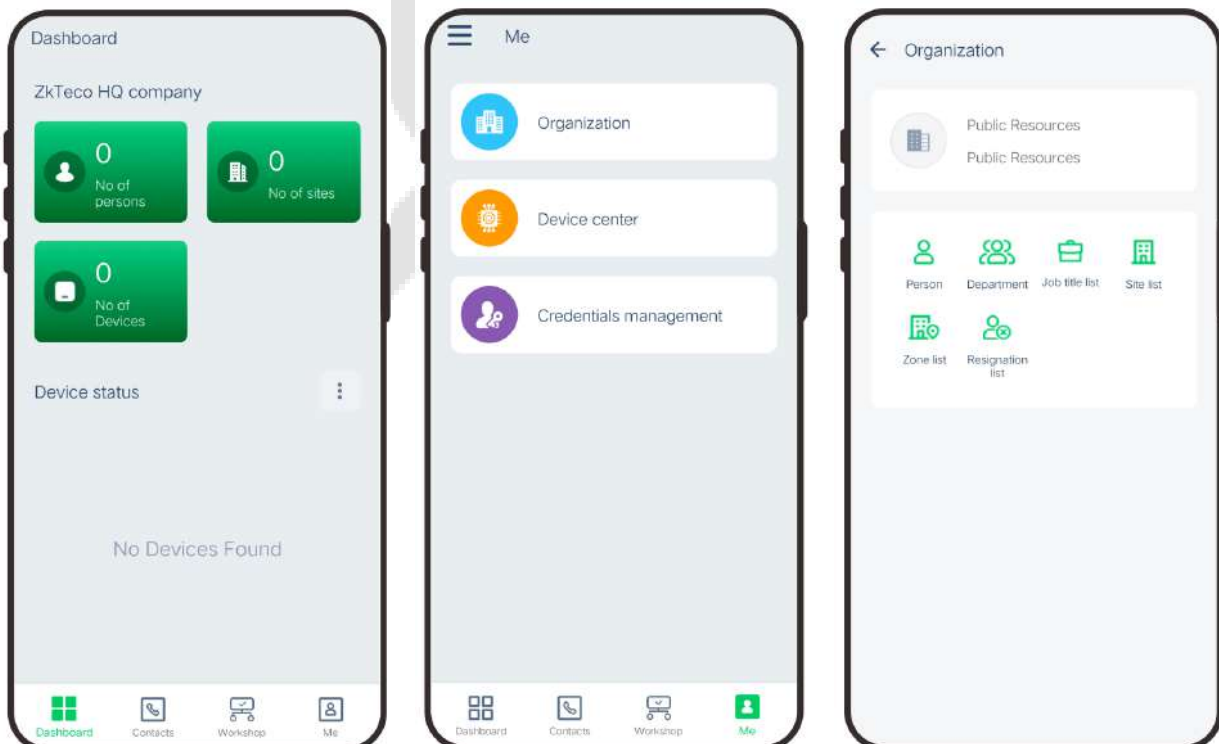

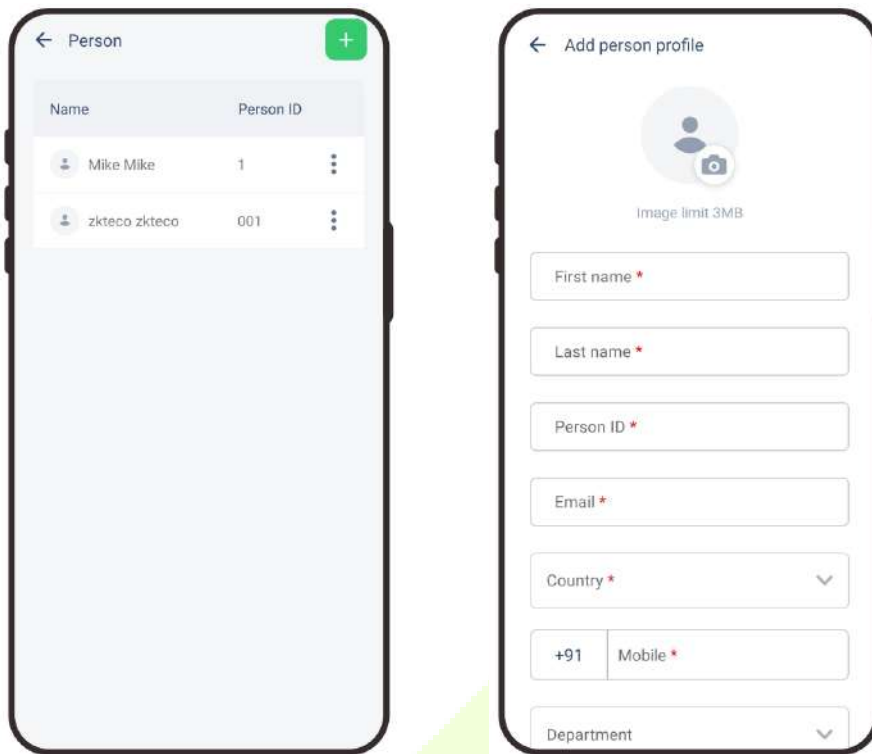

16.3 Add Device

16.3.1 Add Site and Zone

1. Click **Me > Organization > Site (or Zone)** on the main menu.
2. Click  icon to add a new site or zone. Enter the information, and click **Save**.

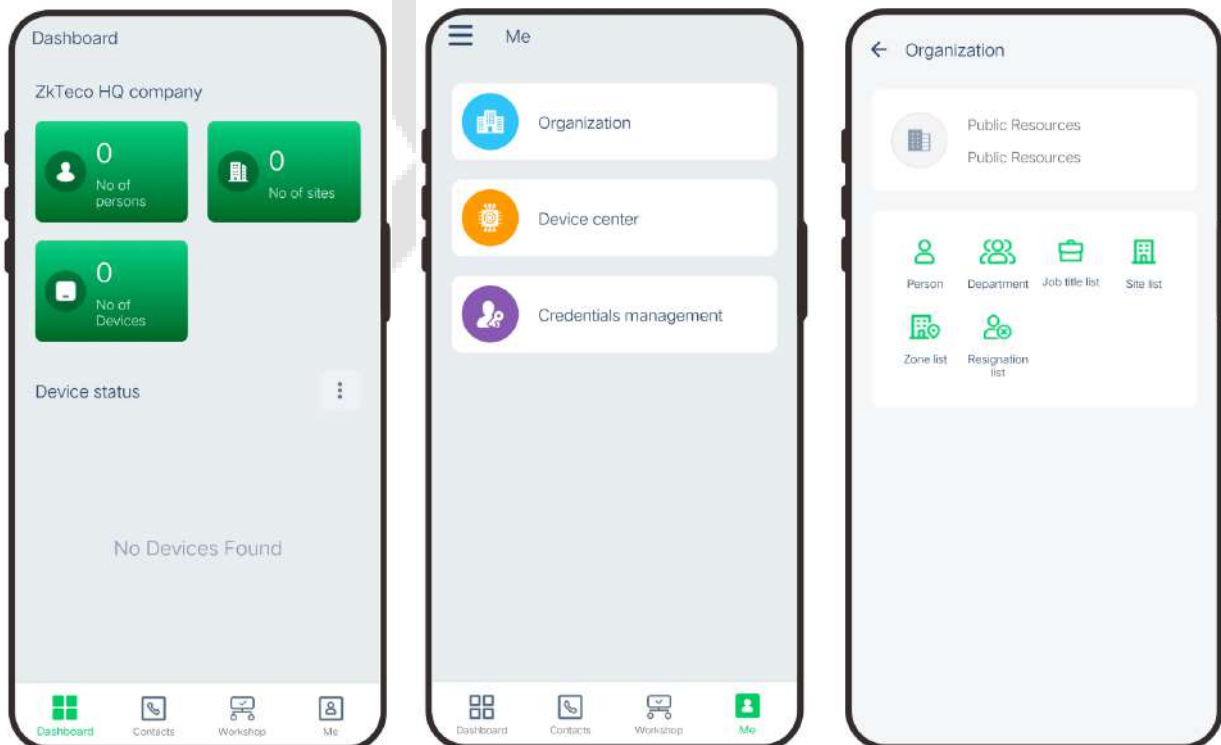

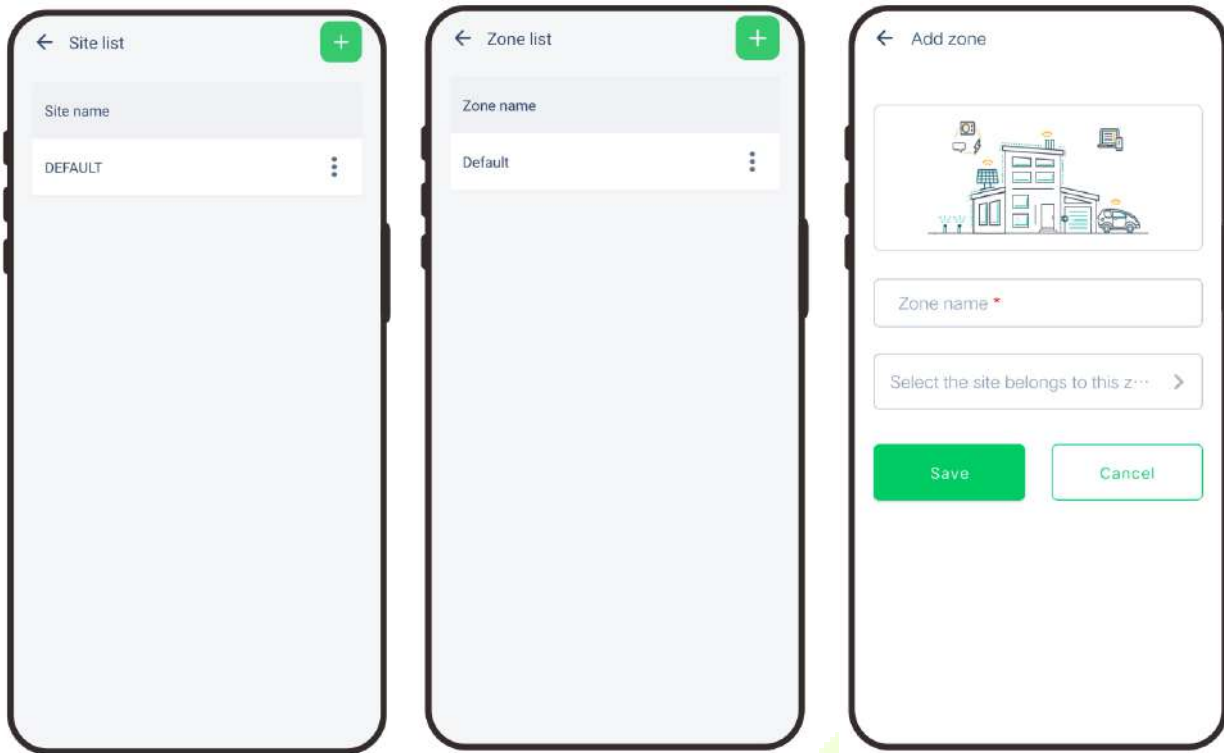

16.3.2 Add Device

1. Tap **COMM.** > **Ethernet** in the main menu on the device to set the IP address and gateway of the device.

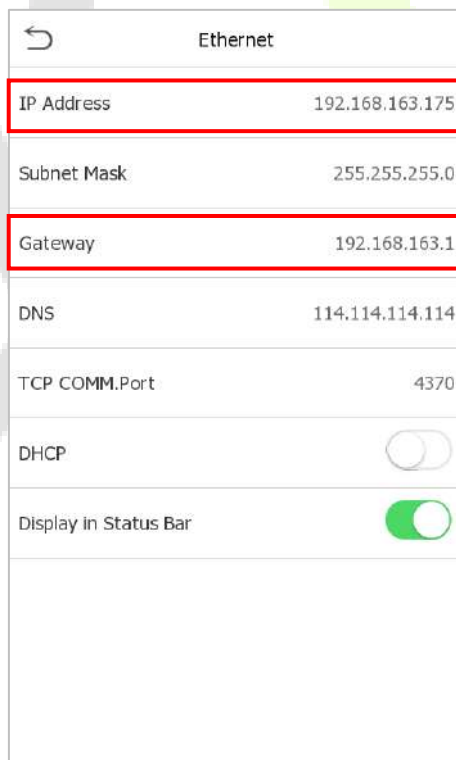

2. Click **Workshop** > **CloudACC** on the main menu to enter the **ZKBio Cloud Access** interface.
3. Click **Me** > **Device List** to enter the **Device** interface. And click  icon to add a new device.

4. Click **Manually register device**.
5. Read and check to the instructions, then click **Continue**.
6. Enter the device’s serial number, then click **Confirm**. (Click **System Info > Device Info** on the device to view the serial number.)

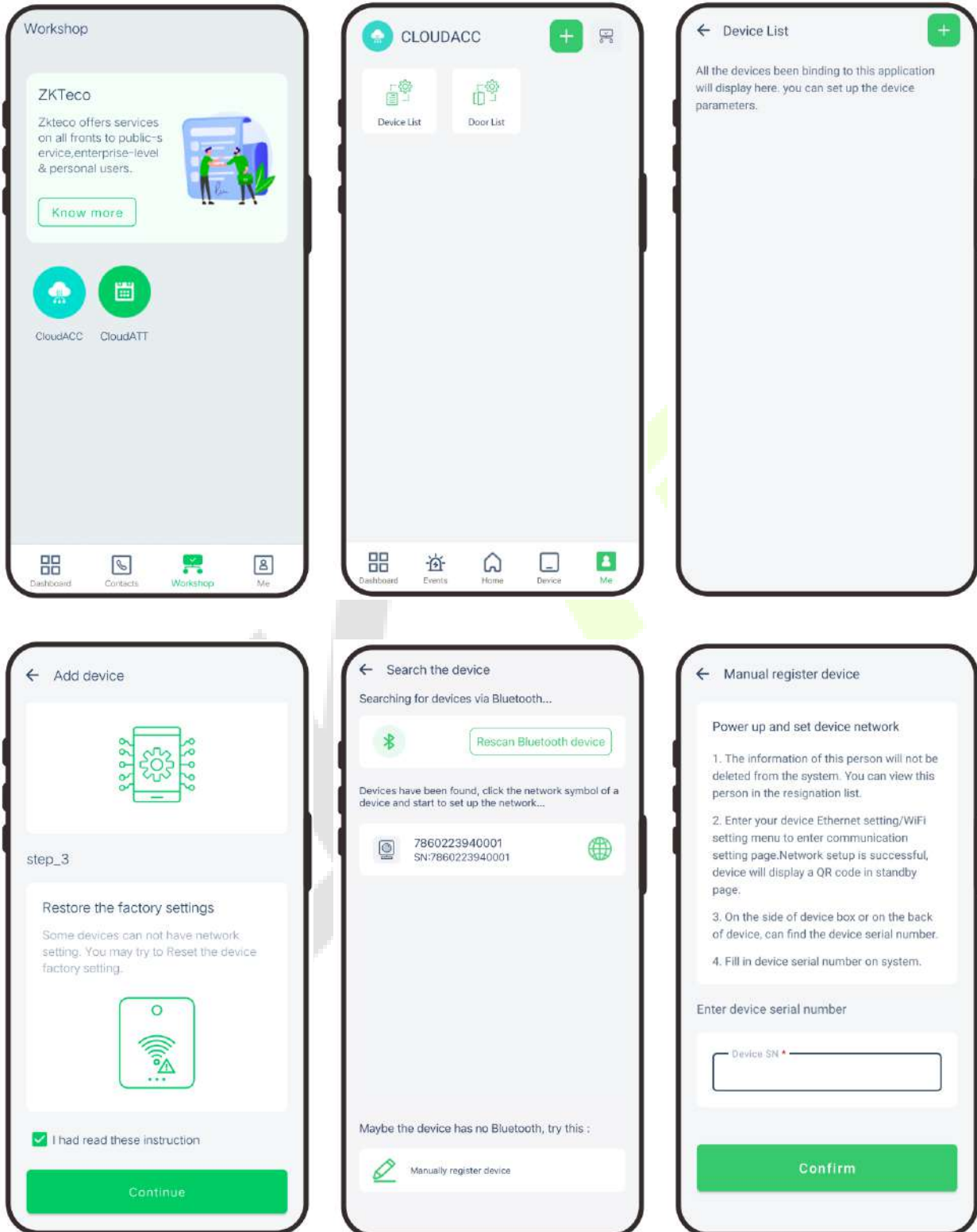

7. Choose a site and a zone, then click **Save** to finish.
8. Then click **Device**, users can view the device status and unlock remotely in this interface.

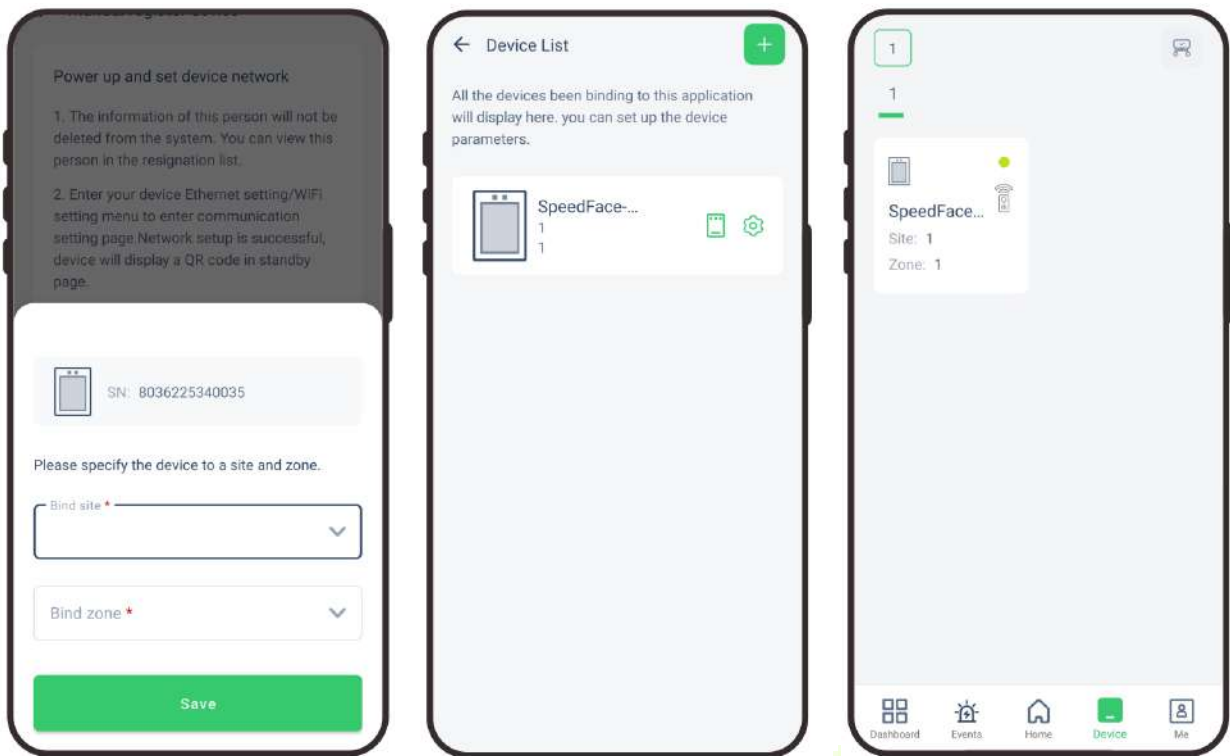

17 Connect to ZKBio CVAccess Software

17.1 Set the Communication Address

- **Device Side**

1. Tap **COMM.** > **Ethernet** in the main menu to set the IP address and gateway of the device.

(**Note:** Please ensure that the IP address is in the same network segment as the server address and can communicate with the ZKBio CVAccess server.)

2. In the main menu, click **COMM.** > **Cloud Server Setting** to set the server address and server port.

Server address: Set the IP address as of ZKBio CVAccess server.

Server port: Set the server port as of ZKBio CVAccess.

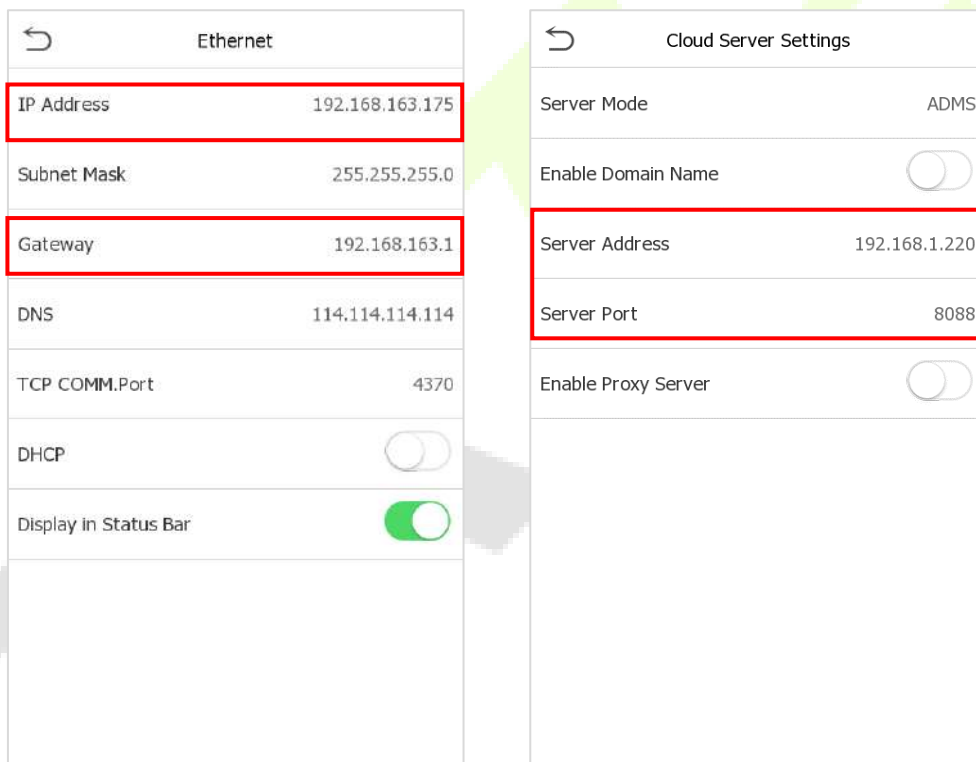

- **Software Side**

Login to ZKBio CVAccess software, click **System** > **Communication** > **Communication Monitor** to set the ADMS service port, as shown in the figure below:

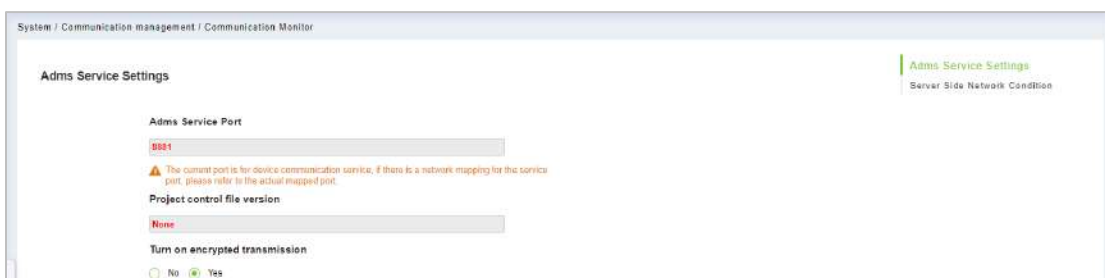

17.2 Add Device on the Software

Add the device by searching. The process is as follows:

1. Click **Access > Device > Search Device**, to open the Search interface in the software.
2. Click **Search**, and it will prompt **Searching**.....
3. After searching, the list and total number of access controllers will be displayed.

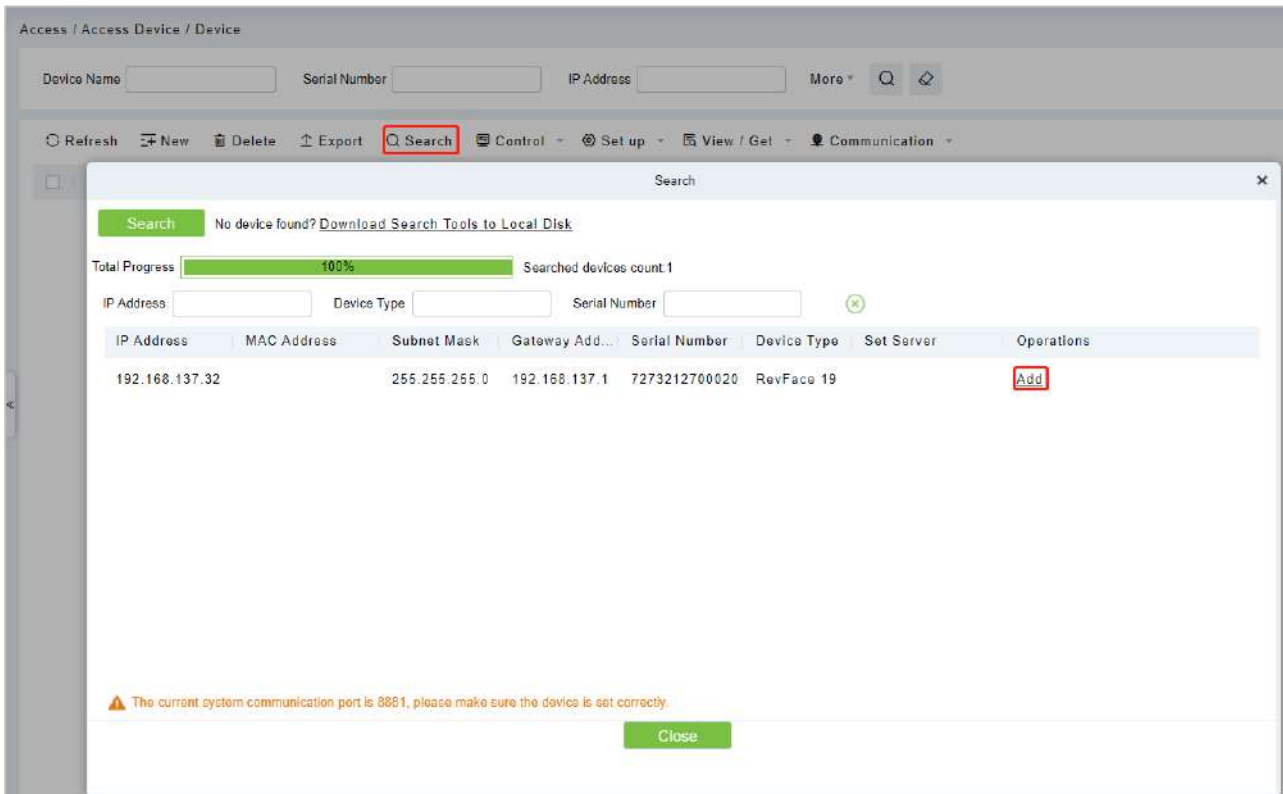

4. Click **Add** in operation column, a new window will pop-up. Select Icon type, Area, and Add to Level from each dropdown and click **OK** to add the device.

17.3 Add Personnel on the Software

1. Click **Personnel > Person > New**:

2. Fill in all the required fields and click **OK** to register a new user.
3. Click **Access > Device > Control > Synchronize All Data to Devices** to synchronize all the data to the device including the new users.

17.4 Mobile Credential

Note: This function is only for SpeedFace-V4L Pro [QR].

After downloading and installing the ZKBioAccess Mobile Page, the user needs to set the Server before login. The steps are given below:

1. In **ZKBio CVAccess > System > System Management > Parameters**, set **Enable QR Code** to "Yes", and select the QR code status according to the actual situation. The default is **Dynamic**, the valid time of the QR code can be set.

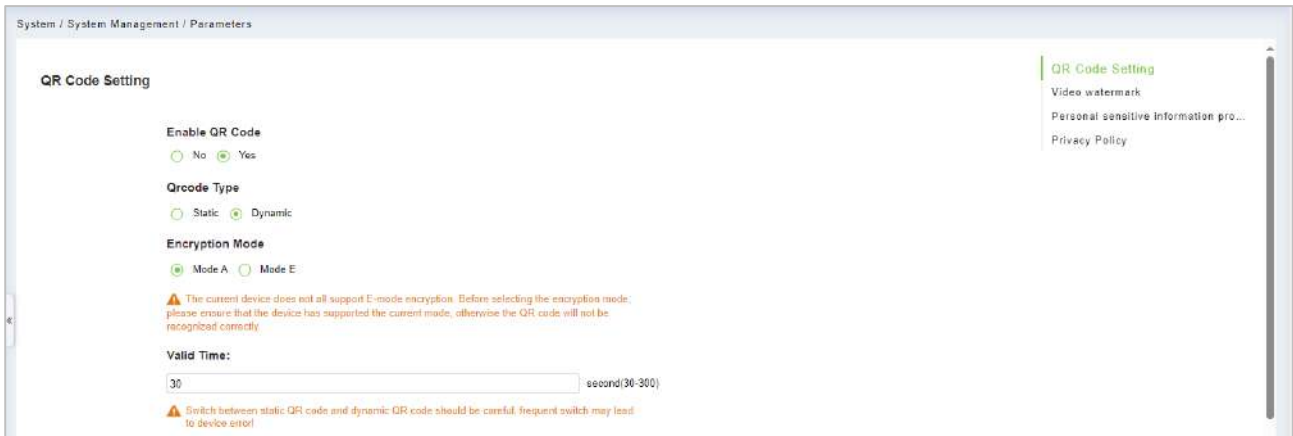

2. On the Server, choose **System > Authority Management > Client Register** to add a registered App client.

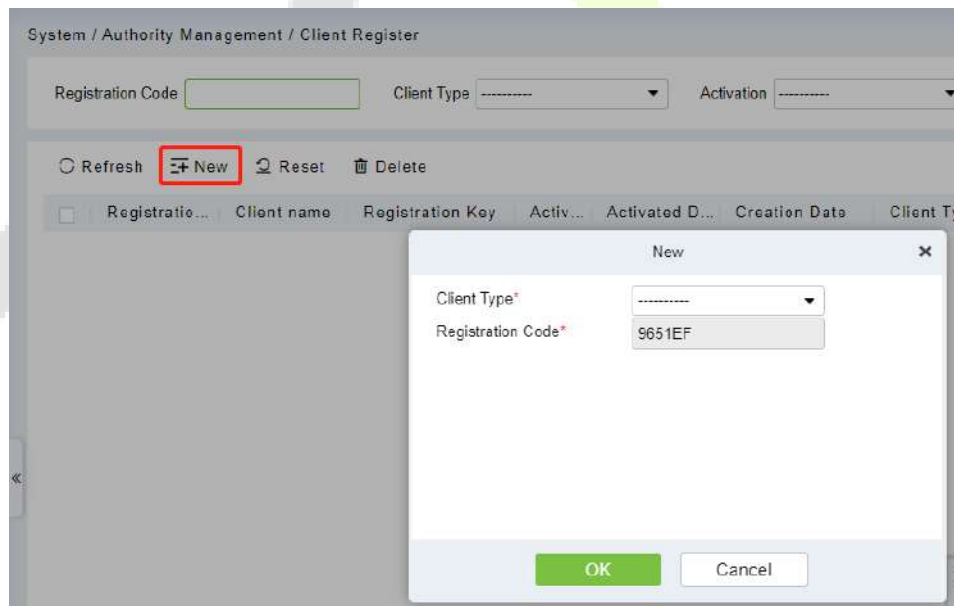

3. Open the App on the Smartphone. On the login screen, tap **Server Setting** and type the IP Address or the domain name of the Server, and its port number.

Note: Smartphone and the Server must be in the same network segment.

4. Tap the **QR Code** icon to scan the QR code of the new App client. After the client is identified successfully, set the client's name and tap **Connection Test**.

- 5. After the network is connected successfully, tap **Save**.

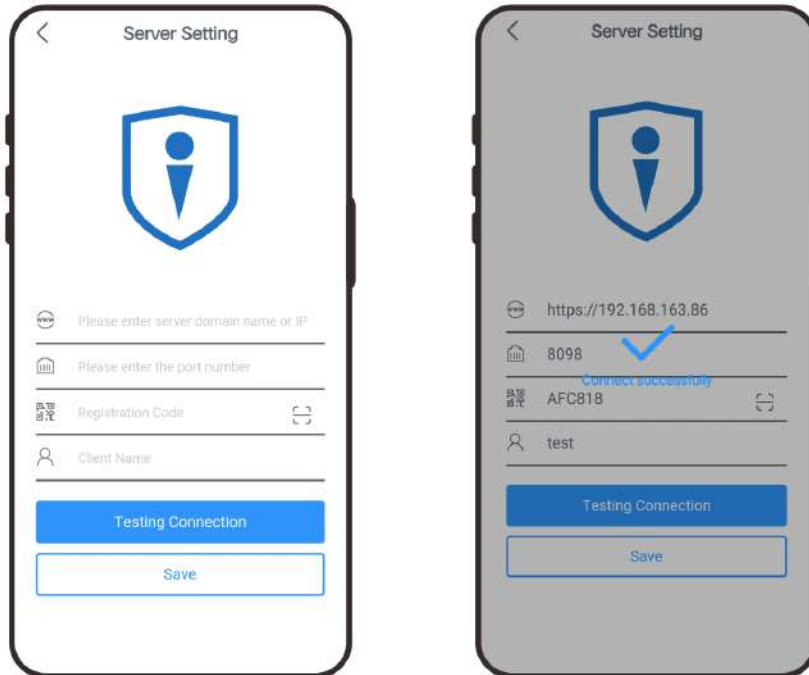

The Mobile Credential function is only valid when logging in as an employee, tap on Employee to switch to employee login screen. Enter the employee ID and password (Default: 123456) to login.

- 6. Tap **Mobile Credential** on the App, and a QR code will appear, which includes employee ID and card number (static QR code only includes card number) information.
- 7. The QR code can replace a physical card on a specific device to achieve contactless authentication to open the door.

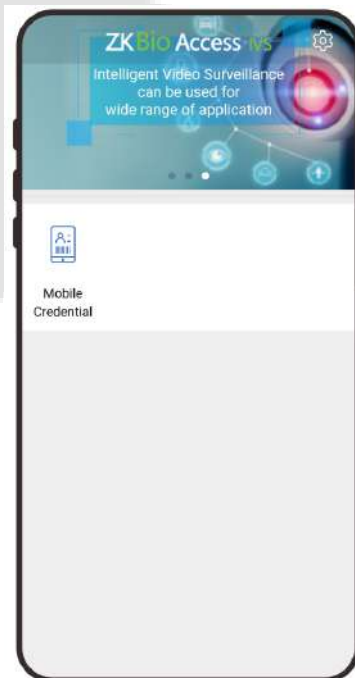

- 8. When using this function for the first time, the App will prompt to authorize the modification of screen brightness settings, as shown in the figure:

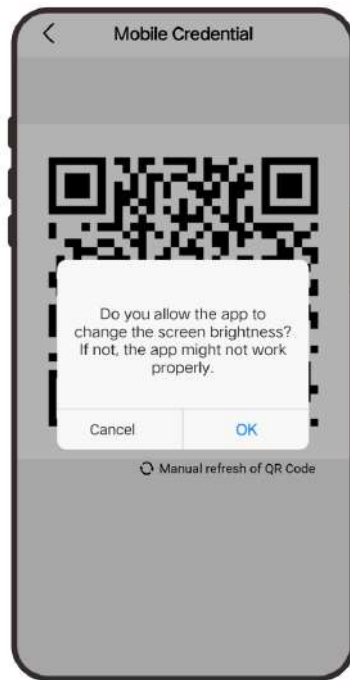

- 9. The QR code refreshes automatically for every 30s and supports manual refresh.





Note: For other specific operations, please refer to ZKBio CVAcess User Manual.

18 Connecting to Wireless Doorbell★

Note: This function needs to be used with the wireless doorbell.

18.1 Connect the Wireless Doorbell

1. First, power on the wireless doorbell. Then, press and hold the music button  for 1.5 seconds until the indicator flashes to indicate it's in pairing mode. After that, click on the SpeedFace-V4L Pro icon , if the wireless doorbell rings and the indicator flashes, it means the connection is successful.



SpeedFace-V4L Pro

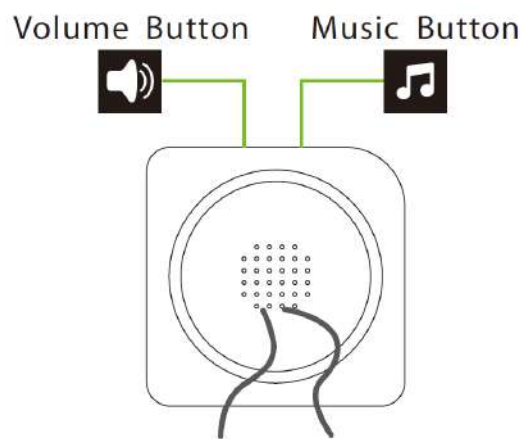

Wireless Doorbell

2. After a successful pairing, clicking the icon  of SpeedFace-V4L Pro will ring the wireless doorbell.

Note: Generally, each SpeedFace-V4L Pro connects to 1 wireless doorbell.

18.2 Unbinding the Wireless Doorbell

Power off the wireless doorbell first, then re-installing the batteries while pressing and holding the music button  until the indicator is on, indicating that the unbinding is successful.

18.3 Settings

On the device, tap on  > **System** > **Video Intercom Parameters** > **Doorbell Setting** to set the doorbell.

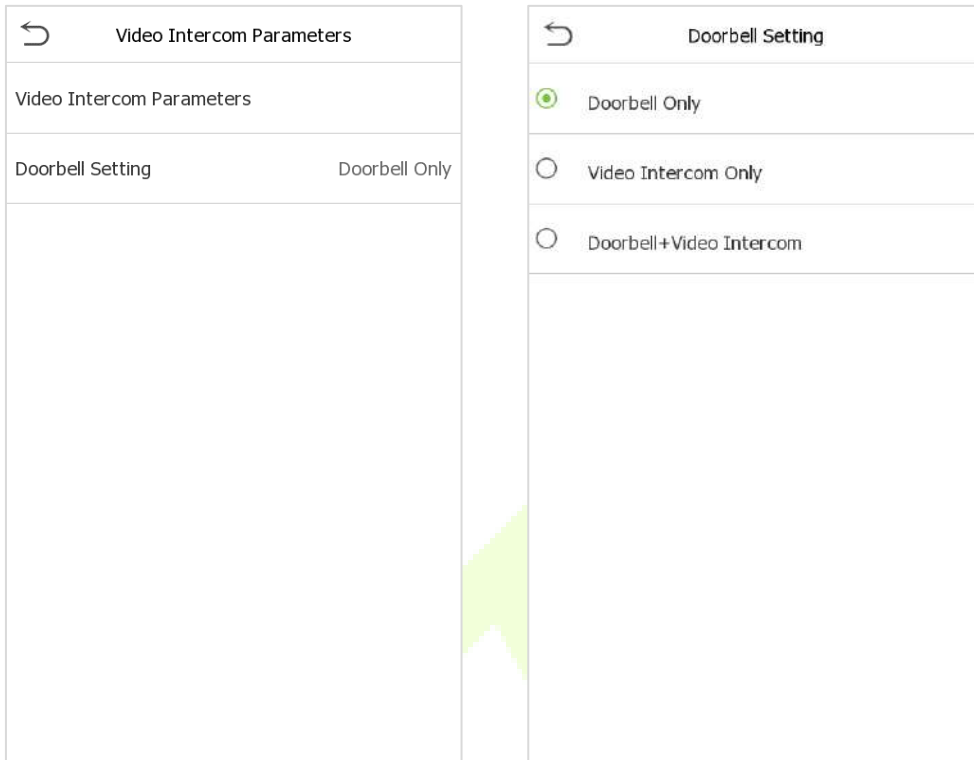

Function Description:

Function Name	Description
Doorbell Setting	<p>Doorbell Only: When the user clicks on the doorbell button, only the doorbell rings.</p> <p>Video Intercom Only: When the user clicks on the doorbell button, only the device makes a call.</p> <p>Doorbell+Video Intercom: When the user clicks on the doorbell button, the doorbell rings and the device makes a call at the same time.</p>

Appendix 1

Requirements of Live Collection and Registration of Visible Light Face Templates

- 1) It is recommended to perform registration in an indoor environment with an appropriate light source without underexposure or overexposure.
- 2) Do not place the device towards outdoor light sources like door or window or other harsh light sources.
- 3) Dark-color apparels, different from the background color is recommended for registration.
- 4) Please expose your face template and forehead properly and do not cover your face template and eyebrows with your hair.
- 5) It is recommended to show a plain facial expression. (A smile is acceptable, but do not close your eyes, or incline your head to any orientation).
- 6) Two templates are required for a person with eyeglasses, one template with eyeglasses and the other without the eyeglasses.
- 7) Do not wear accessories like a scarf or mask that may cover your mouth or chin.
- 8) Please face template right towards the capturing device, and locate your face template in the template capturing area as shown in the template below.
- 9) Do not include more than one face template in the capturing area.
- 10) A distance of 50cm to 80cm is recommended for capturing the template. (The distance is adjustable, subject to body height).



Requirements for Visible Light Digital Face Template Data

The digital photo should be straight-edged, colored, half-portrayed with only one person, and the person should be uncharted and in casuals. Persons who wear eyeglasses should remain to put on eyeglasses for getting photo captured.

- **Eye distance**

200 pixels or above are recommended with no less than 115 pixels of distance.

- **Facial expression**

Neutral face template or smile with eyes naturally open are recommended.

- **Gesture and angel**

Horizontal rotating angle should not exceed $\pm 10^\circ$, elevation should not exceed $\pm 10^\circ$, and depression angle should not exceed $\pm 10^\circ$.

- **Accessories**

Masks or colored eyeglasses are not allowed. The frame of the eyeglasses should not cover eyes and should not reflect light. For persons with thick eyeglasses frame, it is recommended to capture two templates, one with eyeglasses and the other one without the eyeglasses.

- **Face template**

Complete face template with clear contour, real scale, evenly distributed light, and no shadow.

- **Template format**

Should be in BMP, JPG or JPEG.

- **Data requirement**

Should comply with the following requirements:

- 1) White background with dark-colored apparel.
- 2) 24bit true color mode.
- 3) JPG format compressed template with not more than 20kb size.
- 4) Resolution should be between 358 x 441 to 1080 x 1920.
- 5) The vertical scale of head and body should be in a ratio of 2:1.
- 6) The photo should include the captured person's shoulders at the same horizontal level.
- 7) The captured person's eyes should be open and with clearly seen iris.
- 8) Neutral face template or smile is preferred, showing teeth is not preferred.
- 9) The captured person should be clearly visible, natural in color, no harsh shadow or light spot or reflection in face template or background. The contrast and lightness level should be appropriate.

Appendix 2

Privacy Policy

Notice:

To help you better use the products and services of ZKTeco (hereinafter referred as "we", "our", or "us") a smart service provider, we consistently collect your personal information. Since we understand the importance of your personal information, we took your privacy sincerely and we have formulated this privacy policy to protect your personal information. We have listed the privacy policies below to precisely understand the data and privacy protection measures related to our smart products and services.

Before using our products and services, please read carefully and understand all the rules and provisions of this Privacy Policy. If you do not agree to the relevant agreement or any of its terms, you must stop using our products and services.

I. Collected Information

To ensure the normal product operation and help the service improvement, we will collect the information voluntarily provided by you or provided as authorized by you during registration and use or generated as a result of your use of services.

1. **User Registration Information:** At your first registration, the feature template (**Fingerprint template/Face template template/Palm template**) will be saved on the device according to the device type you have selected to verify the unique similarity between you and the User ID you have registered. You can optionally enter your Name and Code. The above information is necessary for you to use our products. If you do not provide such information, you cannot use some features of the product regularly.
2. **Product information:** According to the product model and your granted permission when you install and use our services, the related information of the product on which our services are used will be collected when the product is connected to the software, including the Product Model, Firmware Version Number, Product Serial Number, and Product Capacity Information. **When you connect your product to the software, please carefully read the privacy policy for the specific software.**

II. Product Security and Management

1. When you use our products for the first time, you shall set the Administrator privilege before performing specific operations. Otherwise, you will be frequently reminded to set the Administrator privilege when you enter the main menu interface. **If you still do not set the Administrator privilege after receiving the system prompt, you should be aware of the possible security risk (for example, the data may be manually modified).**

2. All the functions of displaying the biometric information are disabled in our products by default. You can choose Menu > System Settings to set whether to display the biometric information. If you enable these functions, we assume that you are aware of the personal privacy security risks specified in the privacy policy.
3. Only your user ID is displayed by default. You can set whether to display other user verification information (such as Name, Department, Photo, etc.) under the Administrator privilege. **If you choose to display such information, we assume that you are aware of the potential security risks (for example, your photo will be displayed on the device interface).**
4. The camera function is disabled in our products by default. If you want to enable this function to take pictures of yourself for attendance recording or take pictures of strangers for access control, the product will enable the prompt tone of the camera. **Once you enable this function, we assume that you are aware of the potential security risks.**
5. All the data collected by our products is encrypted using the AES 256 algorithm. All the data uploaded by the Administrator to our products are automatically encrypted using the AES 256 algorithm and stored securely. If the Administrator downloads data from our products, we assume that you need to process the data and you have known the potential security risk. In such a case, you shall take the responsibility for storing the data. You shall know that some data cannot be downloaded for sake of data security.
6. All the personal information in our products can be queried, modified, or deleted. If you no longer use our products, please clear your personal data.

III. How we handle personal information of minors

Our products, website and services are mainly designed for adults. Without consent of parents or guardians, minors shall not create their own account. If you are a minor, it is recommended that you ask your parents or guardian to read this Policy carefully, and only use our services or information provided by us with consent of your parents or guardian.

We will only use or disclose personal information of minors collected with their parents' or guardians' consent if and to the extent that such use or disclosure is permitted by law or we have obtained their parents' or guardians' explicit consent, and such use or disclosure is for the purpose of protecting minors.

Upon noticing that we have collected personal information of minors without the prior consent from verifiable parents, we will delete such information as soon as possible.

IV. Others

You can visit https://www.zkteco.com/cn/index/Index/privacy_protection.html to learn more about how we collect, use, and securely store your personal information. To keep pace with the rapid development of technology, adjustment of business operations, and to cope with customer needs, we will constantly deliberate and optimize our privacy protection measures and policies. Welcome to visit our official website at any time to learn our latest privacy policy.

Eco-friendly Operation



The product's "eco-friendly operational period" refers to the time during which this product will not discharge any toxic or hazardous substances when used in accordance with the prerequisites in this manual.

The eco-friendly operational period specified for this product does not include batteries or other components that are easily worn down and must be periodically replaced. The battery's eco-friendly operational period is 5 years.

Hazardous or Toxic substances and their quantities

Component Name	Hazardous/Toxic Substance/Element					
	Lead (Pb)	Mercury (Hg)	Cadmium (Cd)	Hexavalent chromium (Cr6+)	Polybrominated Biphenyls (PBB)	Polybrominated Diphenyl Ethers (PBDE)
Chip Resistor	×	○	○	○	○	○
Chip Capacitor	×	○	○	○	○	○
Chip Inductor	×	○	○	○	○	○
Diode	×	○	○	○	○	○
ESD component	×	○	○	○	○	○
Buzzer	×	○	○	○	○	○
Adapter	×	○	○	○	○	○
Screws	○	○	○	×	○	○

○ indicates that the total amount of toxic content in all the homogeneous materials is below the limit as specified in SJ/T 11363—2006.

× indicates that the total amount of toxic content in all the homogeneous materials exceeds the limit as specified in SJ/T 11363—2006.

Note: 80% of this product's components are manufactured using non-toxic and eco-friendly materials. The components which contain toxins or harmful elements are included due to the current economic or technical limitations which prevent their replacement with non-toxic materials or elements.

ZKTeco Middle East, Bay Square, Building 1,
Office 502 & 503, Business Bay, Dubai, UAE
Phone : +971 4 3927 649
www.zkteco.me

