

# QUICK START GUIDE

Applicable Models: ProCapture-X

---

Version: 1.0

Date: Nov. 2016

# Safety Precautions

Before installation, please read the following safety precautions for user safety and to prevent product damage.



**Do not** install the device in a place subject to direct sun light, humidity, dust or soot.



**Do not** place a magnet near the product. Magnetic objects such as magnet, CRT, TV, monitor or speaker may damage the device.



**Do not** place the device next to heating equipment.



**Do not** to let liquid like water, drinks or chemicals leak inside the device.



**Do not** let children touch the device without supervision.



**Do not** drop or damage the device.



**Do not** disassemble, repair or alter the device.



**Do not** use the device for any purpose other than those specified.



**Clean** the device often to remove dust on it. In cleaning, do not splash water on the device but wipe it out with smooth cloth or towel.

**Contact** your supplier in case of a problem!

# Device Overview

1. Not all products have the functions with ★, the real product shall prevail.
2. The connection cables are not equipped along with the device.

## Front

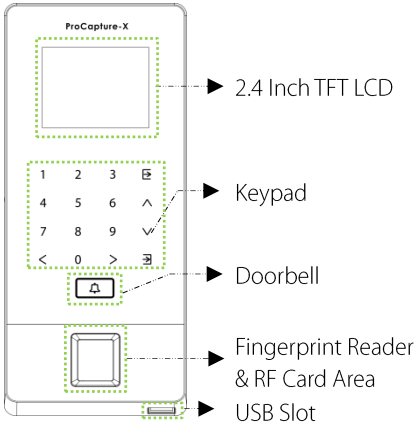

## Side

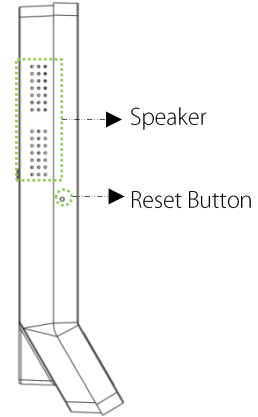

## Back

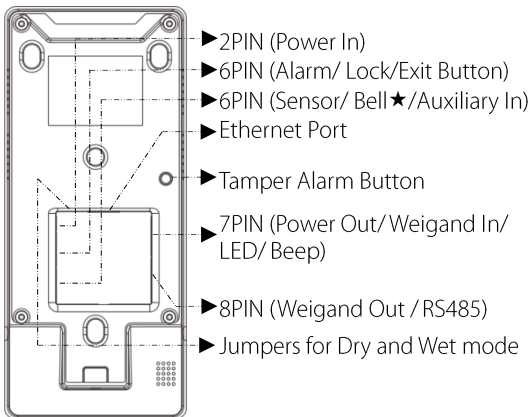

## Bottom

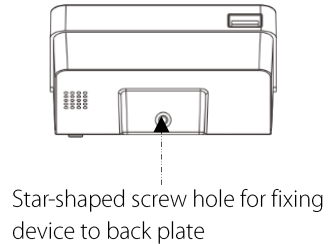

# Device Overview

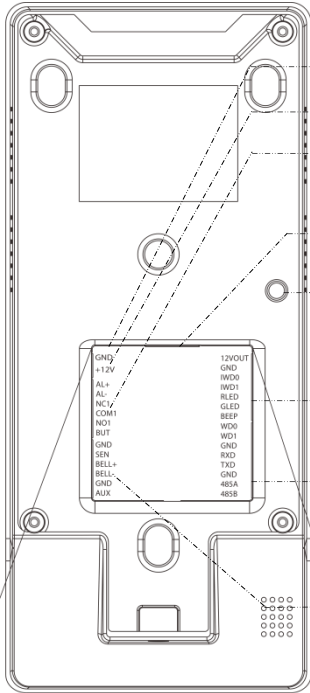

- Power In
- Alarm
- Lock
- Exit Button

- Power Out
- Wiegand In
- Beep, LED
- Wiegand Out
- RS485

- Door Sensor
- Doorbell
- Auxiliary In

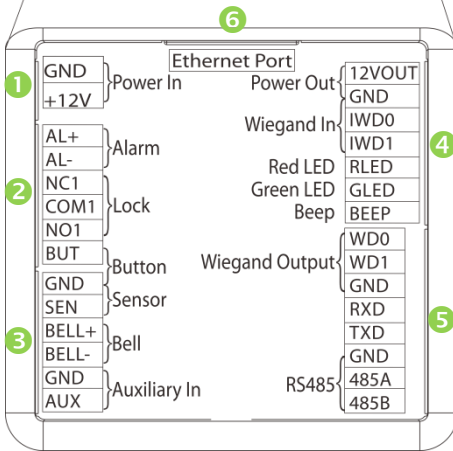

# Device Dimensions & Installation

## ❖ Product Dimensions

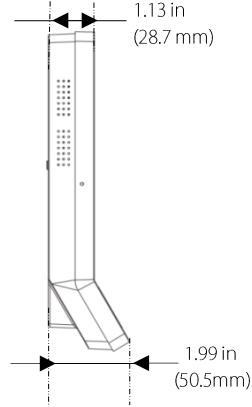
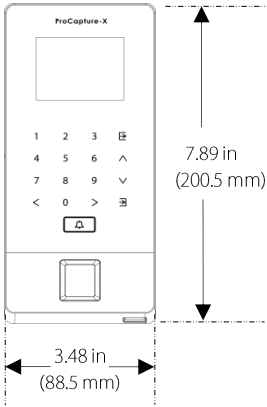

## ❖ Mounting the Device on Wall

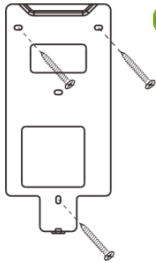

- 1 Fix the back plate onto the wall using wall mounting screws.

**Note:** We recommend drilling the mounting plate screws into solid wood (i.e. stud/beam). If a stud/beam cannot be found, use supplied drywall plastic anchors.

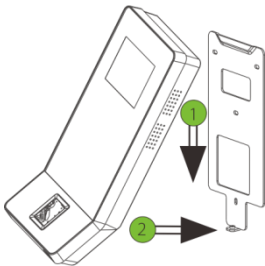

- 2 Insert the device to back plate.

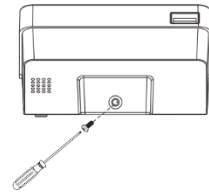

- 3 Use security screws to fasten the device to back plate.

# Power Connection

## ❖ Without UPS

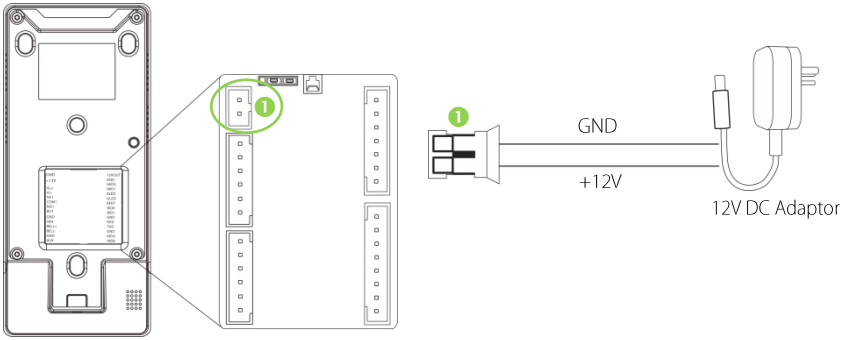

## ❖ With UPS (Optional)

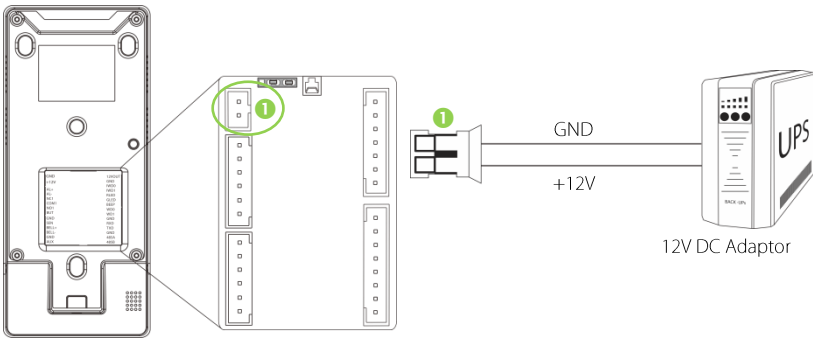

## ❖ Recommended Power Supply

- 12V±10%, at least 500MA.
- To share the power with other devices, use a power supply with higher current ratings.

# Ethernet Connection

## ❖ LAN Connection

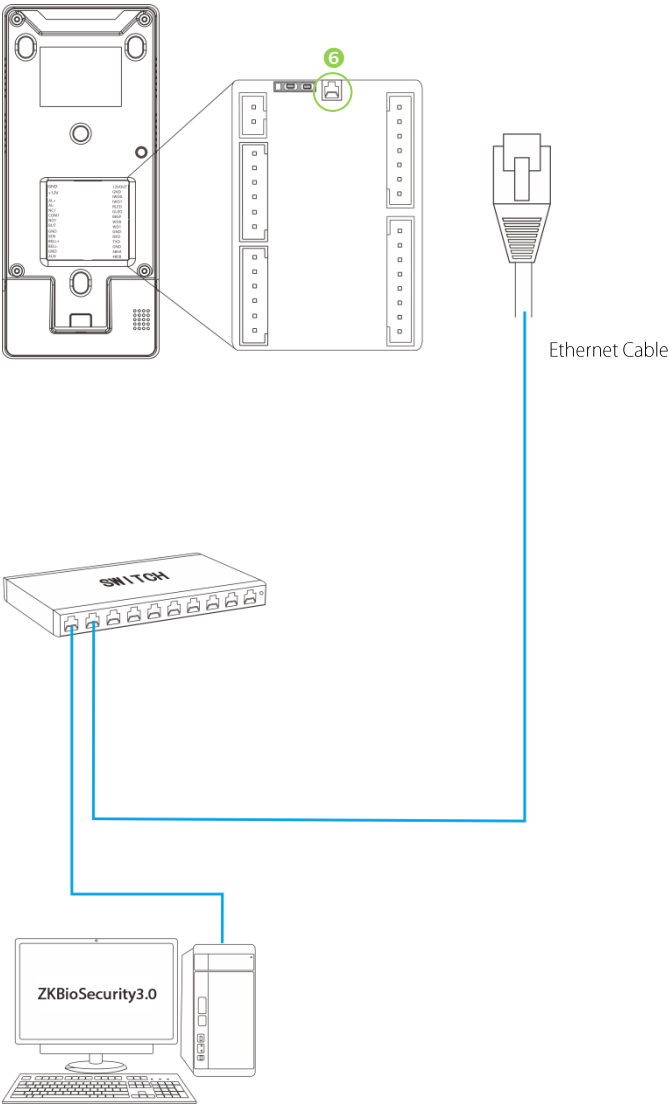

**Note:** The device can be connected to PC directly by Ethernet cable.

# RS485 Connection

## ❖ RS485 Fingerprint Reader Connection

### DESCRIPTION

+12V	
GND	✗
IWD0	✗
IWD1	✗
RLED	✗
GLED	✗
BEEP	✗

4

✗ Do not use

### DESCRIPTION

WD0	✗
WD1	✗
GND	✗
RXD	✗
TXD	✗
GND	
485A	
485B	

5

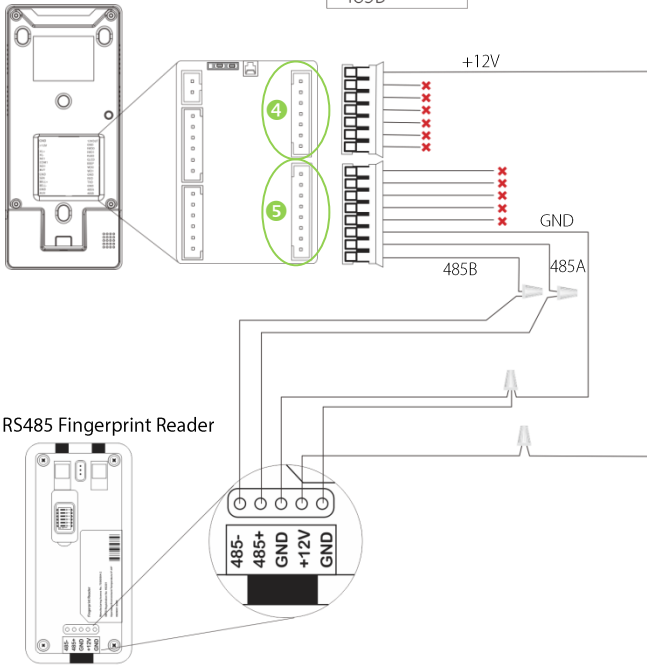

## ❖ DIP Settings

1. There are six DIP switches on the back of RS485 reader, switches 1-4 are for RS485 address, switch 5 is reserved, switch 6 is for reducing noise on long RS485 cable.
2. If RS485 fingerprint reader is powered from the terminal, the length of wire should be less than 100 meters or 330 ft.
3. If the cable length is more than 200 meters or 600 ft., the number 6 switch should be ON as below.

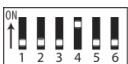



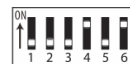

← Distance: More than 200 meters →





# Lock Relay Connection

## ❖ Dry Mode and Wet Mode

1. The device supports “Dry Mode” and “Wet Mode” by setting the jumper. The factory default jumper setting is set as “Dry Mode”, that is, shorten 1-2 and 3-4 .
2. If there is no enough power supply under the working circumstance, “Wet Mode” can also be used, namely, shorten 2-3 and 4-5 .
3. If you want to switch “Dry Mode” to “Wet Mode”, you must take off the jumpers and change  to .

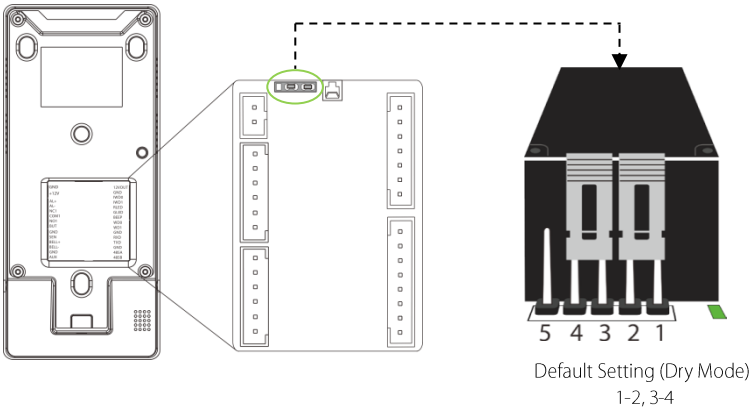

## ❖ Switching Dry Mode to Wet Mode

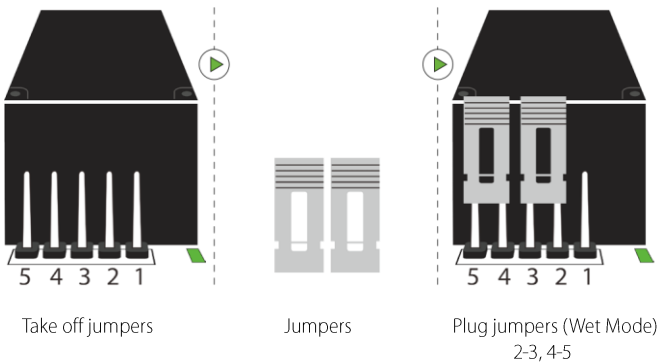

# Lock Relay Connection (Dry Mode)

## ❖ Device Not Sharing Power with the Lock

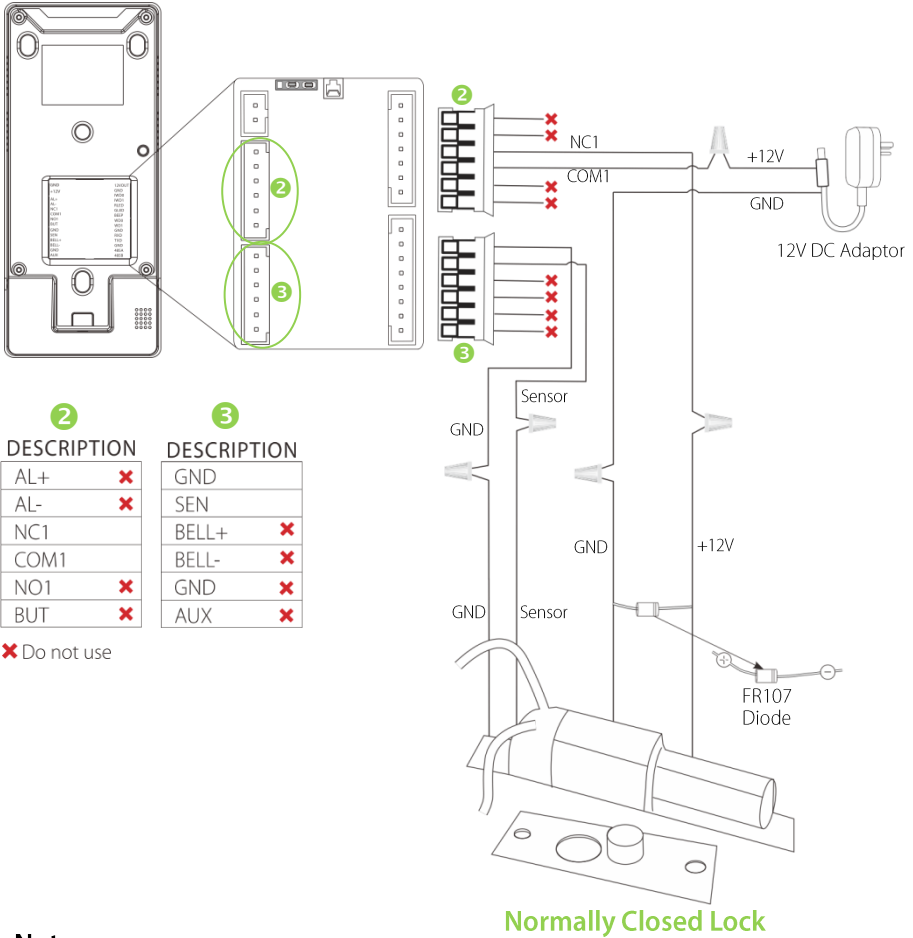

### Notes:

1. The system supports **NO LOCK** and **NC LOCK**. For example the **NO LOCK** (normally opened at power on) is connected with '**NO1**' and '**COM1**' terminals, and the **NC LOCK** (normally closed at power on) is connected with '**NC1**' and '**COM1**' terminals.
2. When electrical lock is connected to the Access Control System, you must parallel one FR107 diode (equipped in the package) to prevent the self-inductance EMF from affecting the system.

 Do not reverse the polarities.

# Lock Relay Connection (Wet Mode)

## ❖ Device Sharing Power with the Lock

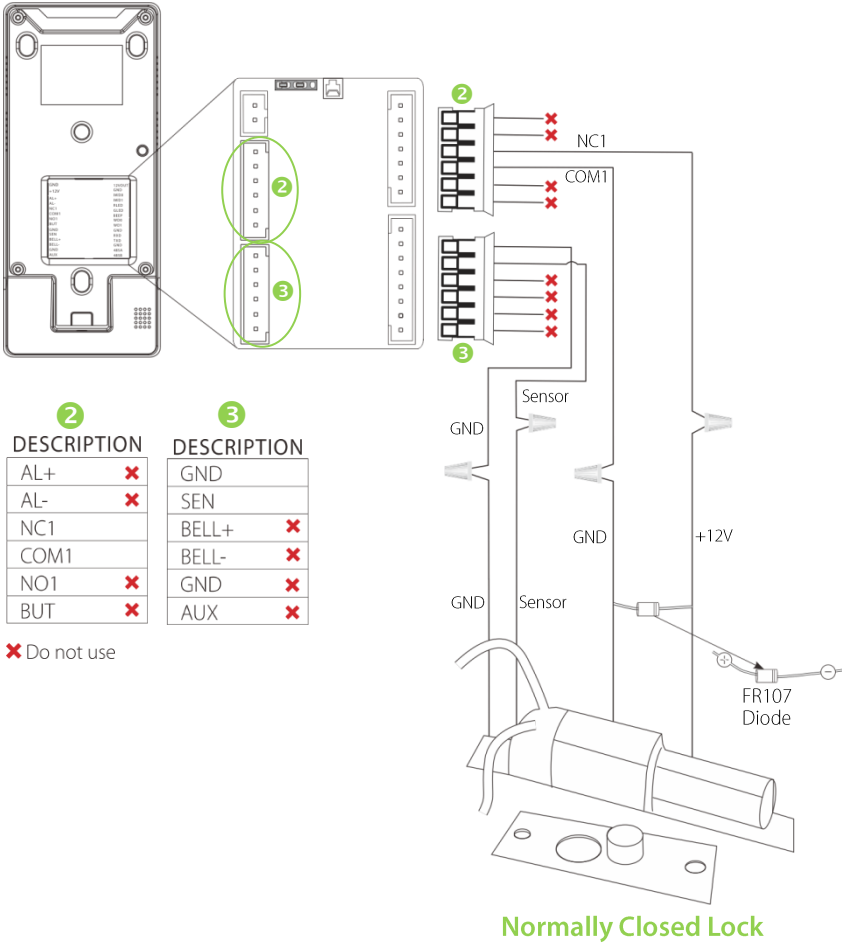

# Wiegand Output Connection

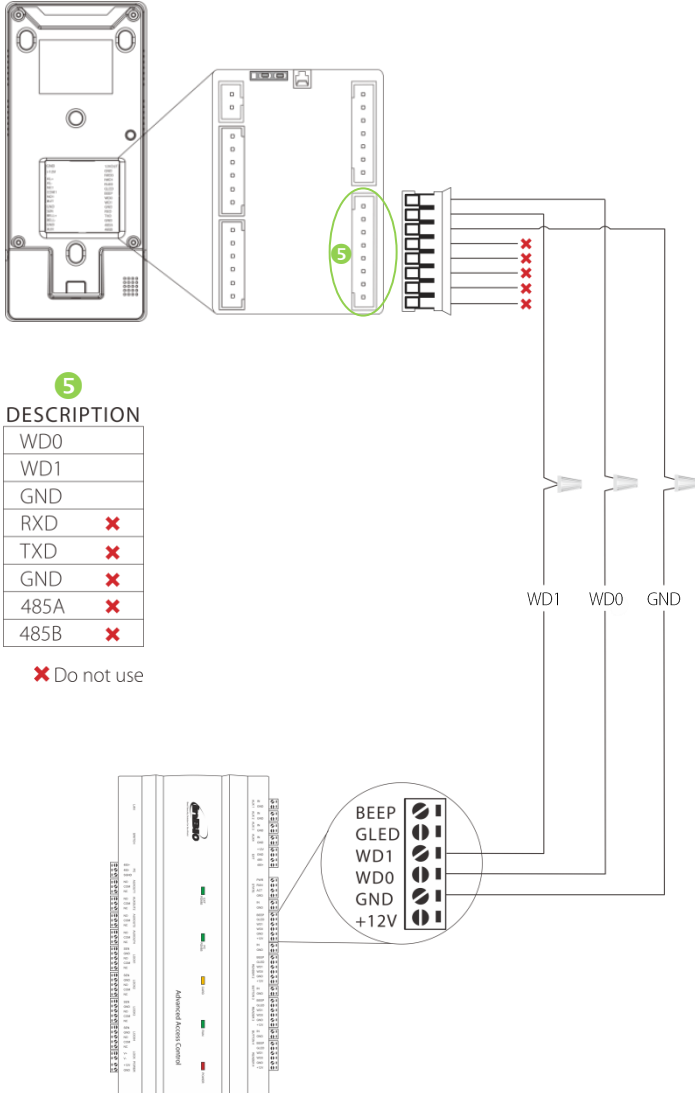

# Standalone Installation

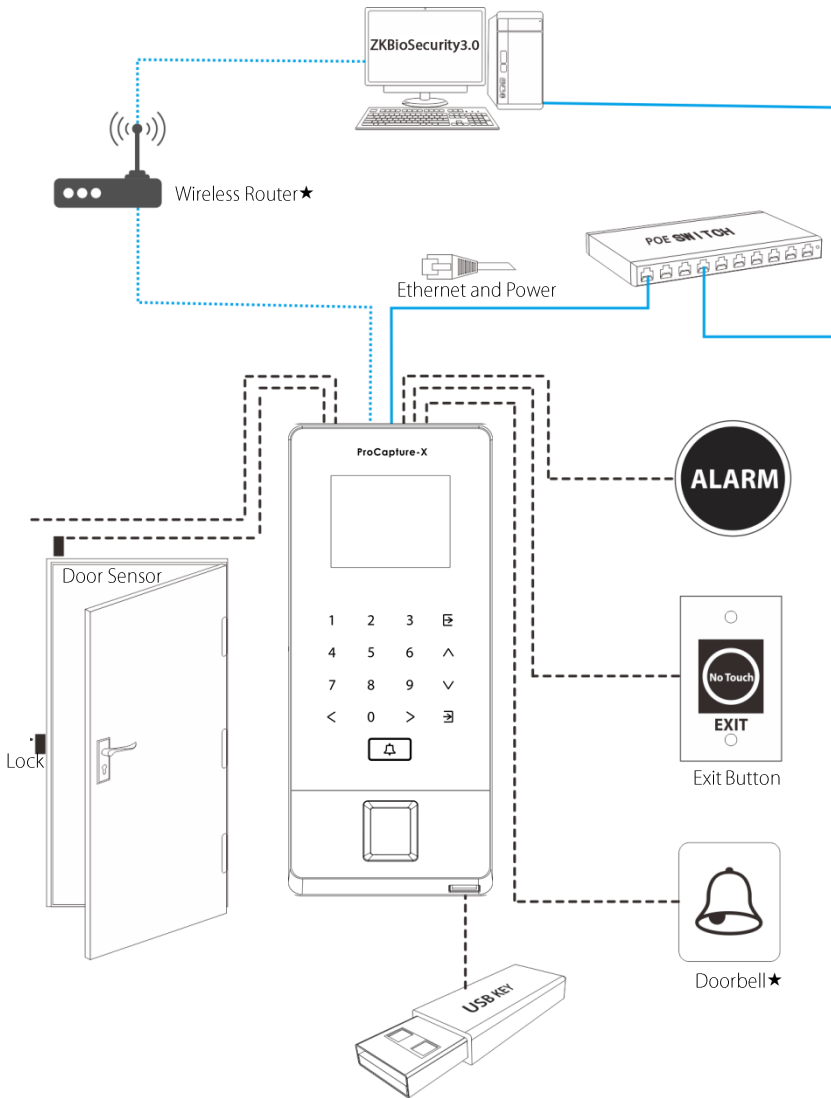

# Device Operation

## ❖ Date / Time Settings

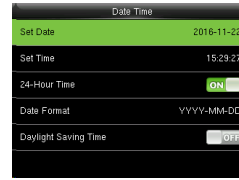
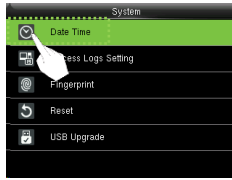

Press **M/OK** icon to enter the main menu> System > Date Time to set date and time.

## ❖ Adding User

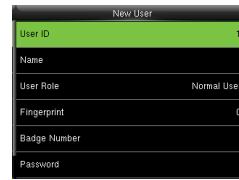
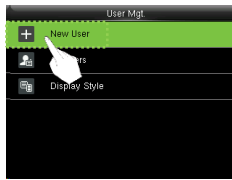

Press **M/OK** icon to enter the main menu> User Mgt. > New User to enter the adding New User interface.

Settings include inputting user ID, user name, choosing user role (Super Admin / Normal User), registering FP / badge number★ / password, and setting access control role.

## ❖ Ethernet Settings

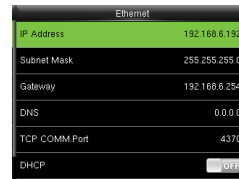
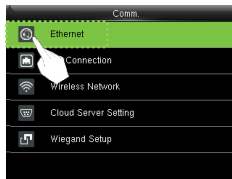

Press **M/OK** icon to enter the main menu > Comm. > Ethernet.

The Parameters below are the factory default values. Please adjust them according to the actual network.

**IP Address:** 192.168.6.192

**Subnet Mask:** 255.255.255.0

**Gateway:** 192.168.6.254

**DNS:** 0.0.0.0

**TCP COMM. Port:** 4370

**DHCP:** Dynamic Host Configuration Protocol, which is to dynamically allocate IP addresses for clients via server. If DHCP is enabled, IP cannot be set manually.

**Display in Status Bar:** To set whether to display the network icon  on the status bar.

# Device Operation

## ❖ WIFI Settings★

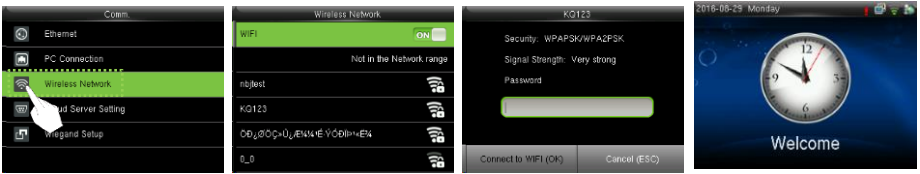

1. Press **M/OK** icon to enter the main menu > Comm. > Wireless Network;
2. Press **M/OK** icon to open WIFI, and search for available WIFI within the network automatically;
3. Select an available WIFI, press **M/OK** icon to input the password;
4. When the Webserver is connected successfully, the initial interface will display the  logo.

## ❖ ADMS Settings

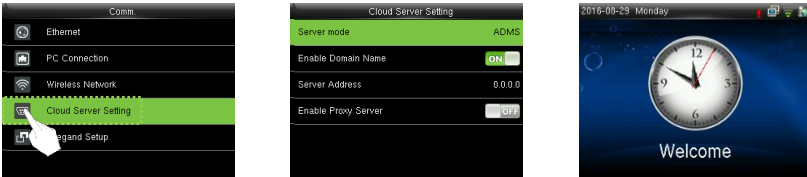

Press **M/OK** icon to enter the main menu > Comm. > Cloud Server Setting to enter the ADMS interface. Set the parameters which are used for connecting with the ADMS server.

When the Webserver is connected successfully, the initial interface will display the  logo.

**Enable Domain Name:** When this function is turned on, the domain name mode "http://..." will be used, such as <http://www.XXX.com>. XXX denotes the domain name when this mode is on; when this mode is off, enter the IP address format in XXX.

**Server Address:** IP address of the ADMS server.

**Server Port:** Port used by the ADMS server.

**Enable Proxy Server:** Method of enabling proxy. To enable proxy, please set the IP address and port number of the proxy server. Entering proxy IP and server address will be the same.

# Device Operation

## ❖ Access Control Settings

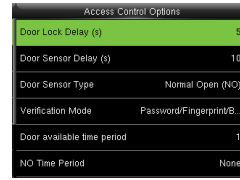
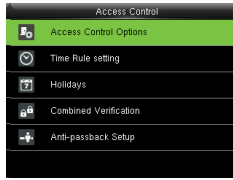

Press **M/OK** icon to enter the main menu > Access Control to enter Access Control setting interface.

To gain access, the registered user must meet the following conditions:

1. User's access time falls within either user's personal time zone or group time zone.
2. User's group must be in the access combo (when there are other groups in the same access combo, verification of members of those groups are also required to unlock the door).

**Access Control Options:** To set parameters of the lock and other related devices.

**Time Rule setting:** It is the minimum unit of access control option.

**Holidays:** Set some days as holidays, and then set Time Schedule of those days.

**Combined Verification:** Make various groups into different access controls to achieve multi-verification and improve security.

**Anti-Passback Setup:** To prevent someone following the employee into the company.

## ❖ Access Control Combination Settings

**E.g.:** Add an access control combination which requires 2 persons' verification from both group 1 (set in User Management) and group 2.

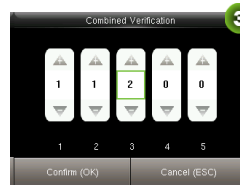
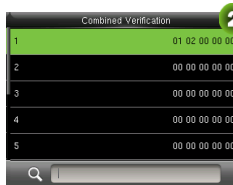
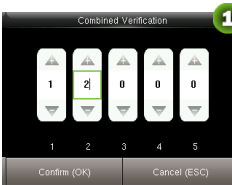

1. In "Combined Verification" List, click the desired combination to modify, and enter the interface (as shown in figure 1).



# Device Operation

2. Click "+/-" to change the number, and click "Confirm" to save and back to "Combined Verification" (as shown in figure 2).

## Note:

1. A single Access Control Combination can consist of a maximum of 5 user groups (in order to open door, verification of all 5 users is required).
2. If the combination is set as shown in figure 3, a user from access group 2 must obtain verification of two users from access group 1 in order to open door.
3. Set all group number to zero to reset access control combination.

## ❖ Troubleshooting

### 1. Fingerprint cannot be read or it takes too long?

- Check whether a finger or fingerprint sensor is stained with sweat, water, or dust.
- Retry after wiping off finger and fingerprint sensor with dry paper tissue or a mildly wet cloth.
- If a fingerprint is too dry, blow on the finger and retry.

### 2. "Invalid time zone" is displayed after verification?

- Contact Administrator to check if the user has the privilege to gain access within that time zone.

### 3. Verification succeeds but the user cannot gain access?

- Check whether the user privilege is set correctly.
- Check whether the lock wiring is correct.

### 4. The Tamper Alarm rings?

- When the device is tampered, the device will send a signal to the speaker then the icon  is displayed on the top right corner and the speaker is ringing. Only the [Speaker Alarm] (Access Control >Access Control Options>Speaker Alarm) is [ON] can user heard the ringing.

Please install the device properly.

# Green Label

ZK Building, Wuhe Road, Gangtou, Bantian, Buji Town,  
Longgang District, Shenzhen China 518129

Tel: +86 755-89602345

Fax: +86 755-89602394

[www.zkteco.com](http://www.zkteco.com)

