

User Manual

Comet Series Speed Gate

Applicable Model(s): Comet-S1000, Comet-S1200

Date: February 2024

Doc Version: 1.1

English

Thank you for choosing our product. Please read the instructions carefully before operation. Follow these instructions to ensure that the product is functioning properly. The images shown in this manual are for illustrative purposes only.



For further details, please visit our Company's website

www.zkteco.com.

Copyright © 2024 ZKTECO CO., LTD. All rights reserved.

Without the prior written consent of ZKTeco, no portion of this manual can be copied or forwarded in any way or form. All parts of this manual belong to ZKTeco and its subsidiaries (hereinafter the "Company" or "ZKTeco").

Trademark

ZKTeco is a registered trademark of ZKTeco. Other trademarks involved in this manual are owned by their respective owners.

Disclaimer

This manual contains information on the operation and maintenance of the ZKTeco equipment. The copyright in all the documents, drawings, etc. in relation to the ZKTeco supplied equipment vests in and is the property of ZKTeco. The contents hereof should not be used or shared by the receiver with any third party without express written permission of ZKTeco.

The contents of this manual must be read as a whole before starting the operation and maintenance of the supplied equipment. If any of the content(s) of the manual seems unclear or incomplete, please contact ZKTeco before starting the operation and maintenance of the said equipment.

It is an essential pre-requisite for the satisfactory operation and maintenance that the operating and maintenance personnel are fully familiar with the design and that the said personnel have received thorough training in operating and maintaining the machine/unit/equipment. It is further essential for the safe operation of the machine/unit/equipment that personnel has read, understood and followed the safety instructions contained in the manual.

In case of any conflict between terms and conditions of this manual and the contract specifications, drawings, instruction sheets or any other contract-related documents, the contract conditions/documents shall prevail. The contract specific conditions/documents shall apply in priority.

ZKTeco offers no warranty, guarantee or representation regarding the completeness of any information contained in this manual or any of the amendments made thereto. ZKTeco does not extend the warranty of any kind, including, without limitation, any warranty of design, merchantability or fitness for a particular purpose.

ZKTeco does not assume responsibility for any errors or omissions in the information or documents which are referenced by or linked to this manual. The entire risk as to the results and performance obtained from using the information is assumed by the user.

ZKTeco in no event shall be liable to the user or any third party for any incidental, consequential, indirect, special, or exemplary damages, including, without limitation, loss of business, loss of profits, business interruption, loss of business information or any pecuniary loss, arising out of, in connection with, or

relating to the use of the information contained in or referenced by this manual, even if ZKTeco has been advised of the possibility of such damages.

This manual and the information contained therein may include technical, other inaccuracies or typographical errors. ZKTeco periodically changes the information herein which will be incorporated into new additions/amendments to the manual. ZKTeco reserves the right to add, delete, amend or modify the information contained in the manual from time to time in the form of circulars, letters, notes, etc. for better operation and safety of the machine/unit/equipment. The said additions or amendments are meant for improvement /better operations of the machine/unit/equipment and such amendments shall not give any right to claim any compensation or damages under any circumstances.

ZKTeco shall in no way be responsible (i) in case the machine/unit/equipment malfunctions due to any non-compliance of the instructions contained in this manual (ii) in case of operation of the machine/unit/equipment beyond the rate limits (iii) in case of operation of the machine and equipment in conditions different from the prescribed conditions of the manual.

The product will be updated from time to time without prior notice. The latest operation procedures and relevant documents are available on <http://www.zkteco.com>

If there is any issue related to the product, please contact us.

ZKTeco Headquarters

Address ZKTeco Industrial Park, No. 32, Industrial Road,
Tangxia Town, Dongguan, China.

Phone +86 769 - 82109991

Fax +86 755 - 89602394

For business-related queries, please write to us at: sales@zkteco.com.

To know more about our global branches, visit www.zkteco.com.

About the Company

ZKTeco is one of the world's largest manufacturer of RFID and Biometric (Fingerprint, Facial, Finger-vein) readers. Product offerings include Access Control readers and panels, Near & Far-range Facial Recognition Cameras, Elevator/floor access controllers, Turnstiles, License Plate Recognition (LPR) gate controllers and Consumer products including battery-operated fingerprint and face-reader Door Locks. Our security solutions are multi-lingual and localized in over 18 different languages. At the ZKTeco state-of-the-art 700,000 square foot ISO9001-certified manufacturing facility, we control manufacturing, product design, component assembly, and logistics/shipping, all under one roof.

The founders of ZKTeco have been determined for independent research and development of biometric verification procedures and the productization of biometric verification SDK, which was initially widely applied in PC security and identity authentication fields. With the continuous enhancement of the development and plenty of market applications, the team has gradually constructed an identity authentication ecosystem and smart security ecosystem, which are based on biometric verification techniques. With years of experience in the industrialization of biometric verifications, ZKTeco was officially established in 2007 and now has been one of the globally leading enterprises in the biometric verification industry owning various patents and being selected as the National High-tech Enterprise for 6 consecutive years. Its products are protected by intellectual property rights.

About the Manual

This manual introduces the operations of **Comet Series Speed Gate**.

All figures displayed are for illustration purposes only. Figures in this manual may not be exactly consistent with the actual products.

Features and parameters with ★ are not available in all devices.

Document Conventions

Conventions used in this manual are listed below:

GUI Conventions

| For Software | |
|------------------|--|
| Convention | Description |
| Bold font | Used to identify software interface names e.g. OK, Confirm, Cancel. |
| > | Multi-level menus are separated by these brackets. For example, File > Create > Folder. |
| For Device | |
| Convention | Description |
| <> | Button or key names for devices. For example, press <OK>. |
| [] | Window names, menu items, data table, and field names are inside square brackets. For example, pop up the [New User] window. |
| / | Multi-level menus are separated by forwarding slashes. For example, [File/Create/Folder]. |

Symbols





| Convention | Description |
|---|--|
|  | This represents a note that needs to pay more attention to. |
|  | The general information which helps in performing the operations faster. |
|  | The information which is significant. |
|  | Care taken to avoid danger or mistakes. |
|  | The statement or event that warns of something or that serves as a cautionary example. |

Table of Contents

| | |
|---|-----------|
| 1 OVERVIEW..... | 8 |
| 1.1 FEATURES | 8 |
| 1.2 APPEARANCE AND SYSTEM COMPONENTS | 9 |
| 1.2.1 APPEARANCE..... | 9 |
| 1.2.2 SYSTEM COMPONENTS..... | 10 |
| 1.3 MECHANICAL SYSTEM..... | 11 |
| 1.4 ELECTRONIC CONTROL SYSTEM | 11 |
| 1.5 WORKING PRINCIPLE..... | 12 |
| 1.6 SYSTEM COMPOSITION..... | 13 |
| 1.7 TECHNICAL SPECIFICATIONS | 14 |
| 2 FUNCTION INTRODUCTION | 16 |
| 2.1 FINGERPRINT VERIFICATION★ | 16 |
| 2.2 CARD VERIFICATION..... | 17 |
| 2.3 QR CODE VERIFICATION..... | 18 |
| 2.4 PALM VERIFICATION★ | 18 |
| 2.5 FACIAL VERIFICATION★ | 19 |
| 3 CONTROL SYSTEM INTRODUCTION | 22 |
| 3.1 ACCESS CONTROL BOARD★ | 22 |
| 3.2 MASTER MOTOR DRIVING CONTROLLER BOARD | 24 |
| 3.3 SLAVE MOTOR DRIVING CONTROLLER BOARD | 26 |
| 3.4 LIGHT CURTAIN CONTROL BOARD | 28 |
| 3.5 LIGHT CONTROL BOARD..... | 29 |
| 3.6 WIRING DIAGRAM..... | 30 |
| 3.7 MENU OF SPEED GATE | 31 |
| 3.8 VOICE PLAYBACK CONTENT CORRESPONDENCE TABLE | 45 |
| 3.9 ERROR CODE FOR TURNSTILE..... | 48 |
| 4 MAINTENANCE | 49 |
| 4.1 CHASSIS MAINTENANCE..... | 49 |
| 4.2 MOVEMENT MAINTENANCE..... | 49 |
| 4.3 POWER SUPPLY MAINTENANCE | 49 |
| 5 TROUBLESHOOTING..... | 50 |
| 6 PACKING LIST | 51 |

Revision History

| Revision | Date | Author | Reviewer | Description |
|----------|------------|-------------|----------|---|
| V1.0 | 08/09/2023 | Yang Kaijin | | Original Document |
| V1.1 | 02/23/2024 | Yang Kaijin | | The appearance of the device, wiring diagram and function menu have been changed. Voice playback have been added. |

1 Overview

Speed gate Comet series is high-end pedestrian passage gate device developed, produced and sold by ZKTeco, boasting a durable aluminum shell treated for anti-corrosion. Its motor, powered by a precision-type planetary reducer BLDC (Brushless DC) motor. Equipped with high-quality infrared sensors, it delivers accurate detection, and strong anti-interference, and adapts to various environments with multiple logic judgments. Featuring the latest driver technology, it supports multiple mode switching and includes protections against over-current, over-voltage, and over-temperature, making it ideal for office buildings, commercial establishments, and other upscale locations.

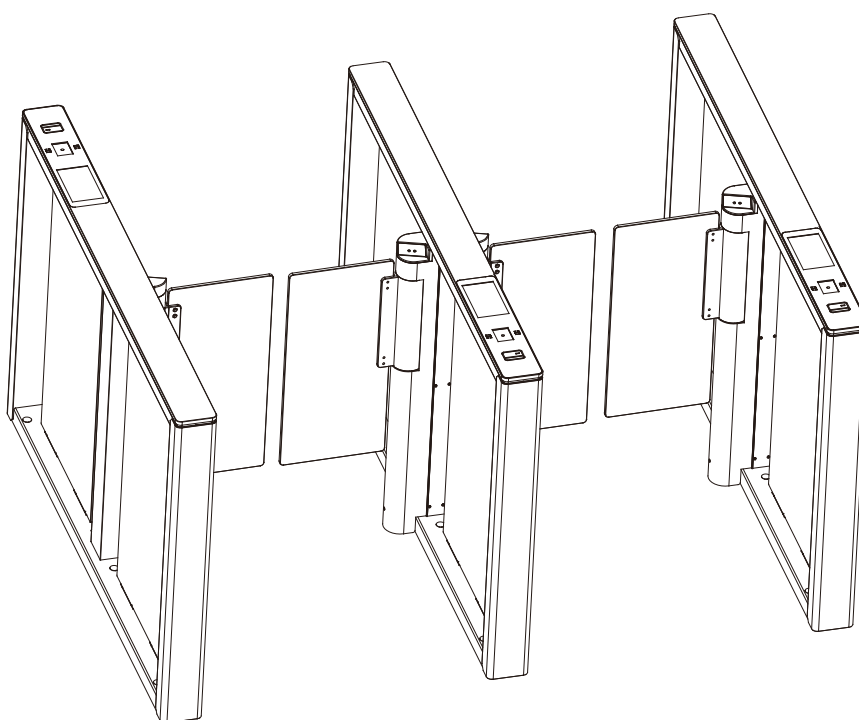

1.1 Features

- Long service life, capable of opening and closing the gate more than 6 million times when measured.
- Multi alarm function, such as break-in, wrong direction entry and door open overtime alert.
- Emergency mode automatically opens the gate in case of power failure or fire signal trigger.
- Security function prevents unauthorized entry by engaging a pair of clutches if the barrier is forced, automatically resetting after engagement.
- Self-protection function to prevent strong intrusion, excessive current and other special circumstances, such as damage to the product, death, etc.

- Multiple anti-pinch functions ensure pedestrian safety, including infrared anti-pinch protection and secondary infrared blocking.
- Unload the force when encountering blocking to prevent bruising pedestrians.
- Combined with peripheral verification devices, it supports face, human ID, RFID card, ESD device, sweep code and other verification methods.
- Memory function allows passage of multiple people after several consecutive swipes.
- Development interfaces available for system integration.
- Aluminum alloy case ensures long-lasting durability.
- Operates smoothly, silently, and consumes low power.
- An embedded LED strip is situated along the barrier's side, offering a spectrum of 7 RGB colours and a range of visual effects. This feature is fully customizable to meet our customer's unique preferences.

1.2 Appearance and System Components

1.2.1 Appearance

The appearance and dimensions of the Comet series are shown in the figure below:

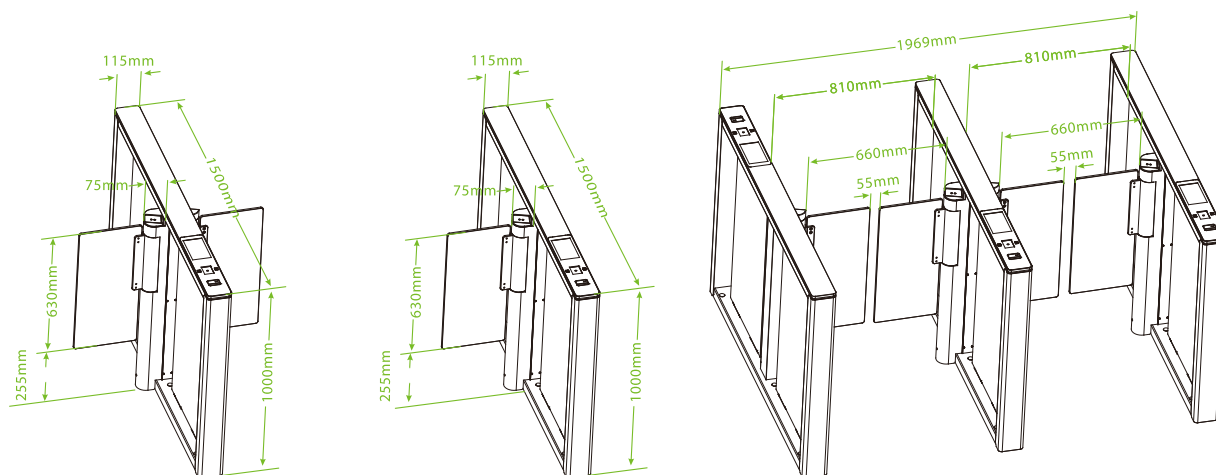

1.2.2 System Components

The system components of the Comet series are shown below:

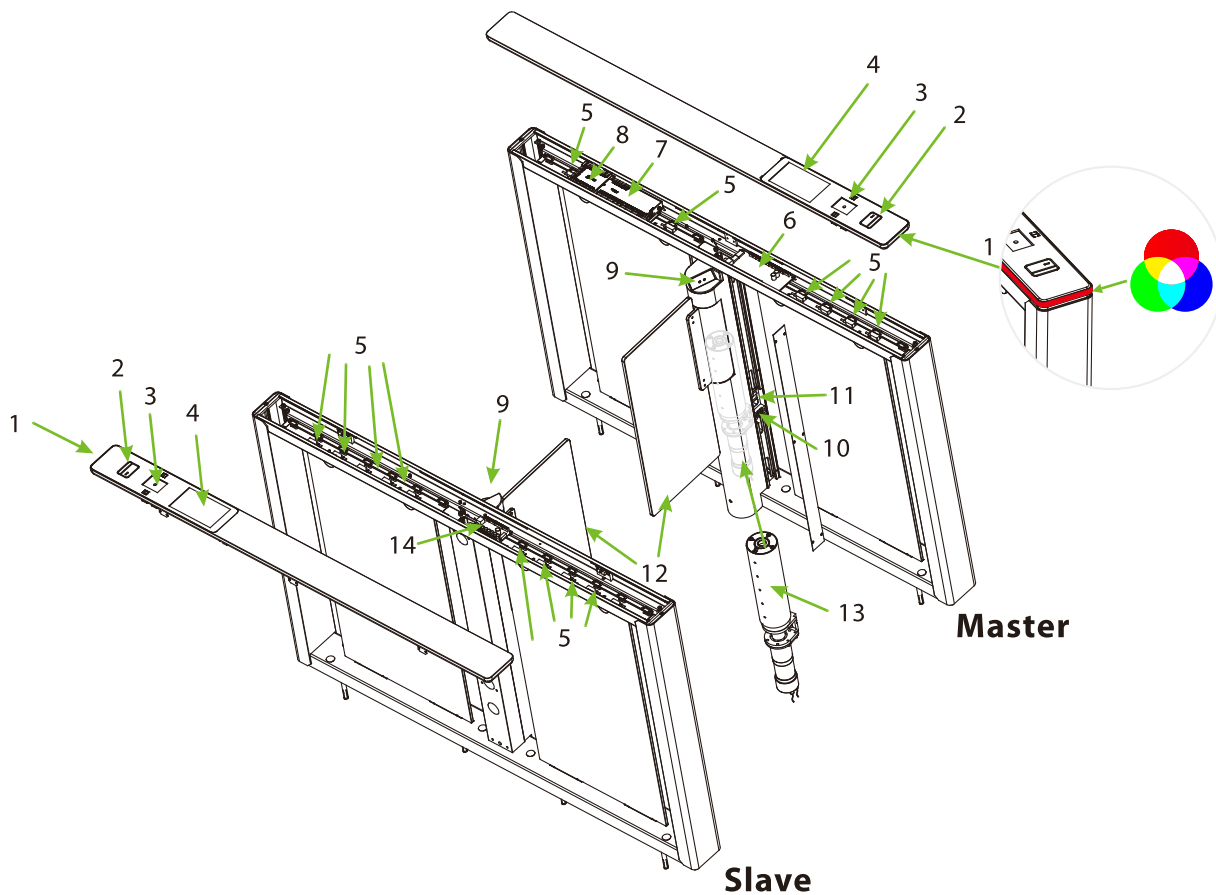

| | |
|--|---|
| 1. Traffic Indicator | 2. Card Reading |
| 3. Verification Units★ | 4. 7-inch Touchscreens★ |
| 5. Infrared Sensor | 6. Master Turnstile Controller Board |
| 7. Access Controller Board ★ | 8. Infrared Expansion★ |
| 9. Facial Recognition Machine ★ | 10. Power Supply |
| 11. Motor Switch | 12. Swing Arm |
| 13. Motor | 14. Slave Turnstile Controller Board |

1.3 Mechanical System

The mechanical system of the turnstile consists of the chassis and the core component. The chassis serves as a carrier where the Traffic Indicator, Reader, QR code scanner/Palm scanner★, Fingerprint reader★, Camera★, Infrared Sensor and the Door lock are installed. The core component mainly consists of the Motor, Frame, Bearing and Swing Arm.

1.4 Electronic Control System

The electronic control system of a turnstile mainly consists of the Reader/QR code scanner/ Palm scanner★/Fingerprint reader★/Camera★, Infrared Sensor, Turnstile Control Board, Traffic Indicator and Alarm.

Reader: The reader reads the data on the card and transmits it to the Access Controller.

Fingerprint Reader★: The device compares the fingerprint that is being pressed onto the fingerprint reader with all the fingerprint data and sends it to the Access Controller.

Palm Scanner★: The device compares the palm image collected by the palm module with all the palm data templates in the device and sends it to the Access Controller.

QR code Reader: The device compares the acquired QR code with all QR code data registered in the device and sends it to the Access Controller.

Camera★: The device compares the collected facial images with all of the face data registered in the device and then sends it to the Access Controller.

Infrared Sensor: It detects the position of the pedestrian and plays a role in ensuring safety and protection.

Turnstile Control Board: The Turnstile control board is the system's control center that receives signals from the Card reader/fingerprint reader★/QR code reader/ Palm scanner★/Camera★. The IR performs logical calculation and processing of these signals and then sends executive commands to the Traffic Indicator, Electric Motor, and alarm.

Traffic Indicator: When the gate is closed, the system will illuminate the red indicator. However, when someone successfully passes the verification, the system will illuminate the green indicator.

Alarm: The alarm gives the voice and light alarm if the system detects any unauthorized entry to the passage, false direction entry, anti-tailgate and other violations.

1.5 Working Principle

1. When the device is powered on, the device undergoes a Power-On Self-Test (POST). If no issues are detected during the test, the device will operate normally. If a failure is detected, the system will display relevant error messages on the digital tube, allowing the user to quickly identify and resolve the problem.

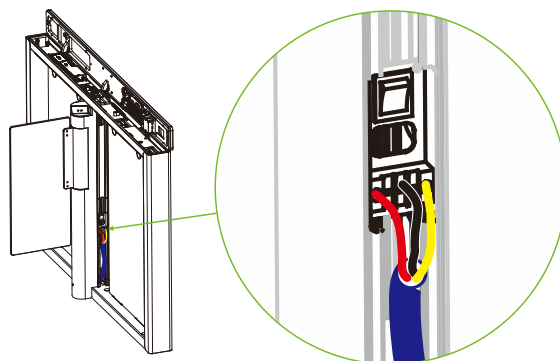

2. When a valid card/fingerprint★/QR code/Palm★/Face★, the display will show whether it is successful or not, and the buzzer will give a positive audible prompt to the pedestrian, indicating that successfully verified. Then, the card reader/fingerprint reader★/QR code reader/Palm scanner★/Camera★ sends signals to the Access Controller to request permission to pass through the passage. The Access Controller will send the signal to the Turnstile Control Board.
3. After receiving the signal from the card/fingerprint★/QR code/Palm★/Face★ and the Infrared Sensor, the Turnstile Control Board will send valid control signals to the servo motor driver. At this time, if the system is in forbidden passing mode, the mode indicator light will turn red, and the Turnstile Control Board will not accept signals of card/fingerprint★/QR code/Palm★/Face★.
4. After the passenger passes through the channel in accordance with the opening direction of the swing arm, the Infrared Sensor will continuously monitor the pedestrian's movement throughout the passage. It will continue to send signals to the Turnstile Control Board until the pedestrian completes the passage.
5. If the pedestrian enters the passage without verifying their identification or presents an invalid card/fingerprint★/QR code/Palm★/Face★ the system will sound an audible alarm to alert the pedestrian to stop. The alarm signal will persist until the pedestrian retreats from the passage. Only after a card/fingerprint★/QR code/Palm★/Face★ is successfully verified can the pedestrian process through the passage.

Note: Make sure the ground wire of the system is reliably connected to avoid personal injuries or other accidents.

1.6 System Composition

The single-passage management system consists of two single-core speed gates. The multi-passage management system consists of two single-core speed gates and multiple dual-core speed gates.

- **The single-lane management system:**

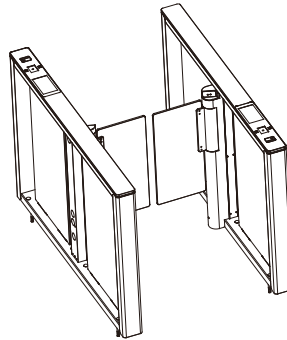

- **The multi-lane management system:**

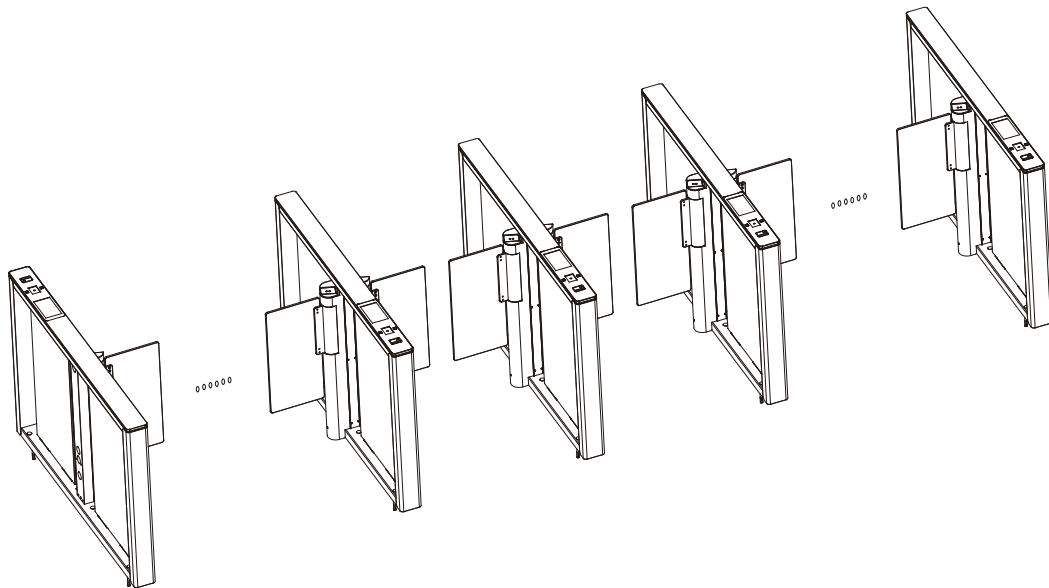

1.7 Technical Specifications

| Feature | Specification |
|------------------------------|---|
| Communication | TCP/IP, RS485 |
| Input Voltage | AC110V/240V, 50/60Hz |
| Input Control Signal | Dry contact |
| Output Voltage | DC 24V |
| Protection Level | N/A |
| Time of Gate Opening/Closing | 0.8 to 3s |
| Operating Humidity | 5% to 80% (Non-condensing) |
| Operating Temperature | -28°C to 60°C (Standard) |
| Throughput Rate | Up to 25 people/min (Using credentials) |
| Infrared Sensor | 8 pairs |
| LED Indicator | Support (RGB color) |
| Working Environment | Indoor |
| Drive Unit | Brushless motor |
| Barrier Movement | Swing |
| Lane Width | 660mm (Option: 900mm) |
| MCBF | 6 Millions |
| Dimension (mm) (L*W*H) | 1500*115*998.4 |
| Net Weight | 50kg*2 (±5kg) |

| | |
|-------------------|--|
| Gross Weight | 64kg*2 (± 5 kg) |
| Noise | <60dB |
| Certifications | CE and FCC |
| Traffic Indicator | Green: Lane available Red: Lane unavailable |

2 Function Introduction

2.1 Fingerprint Verification★

In this verification mode, the device compares the fingerprint that is being pressed onto the fingerprint reader with all the fingerprint data sends and it to the Access Controller.

The device enters the fingerprint authentication mode when a user presses their finger onto the fingerprint scanner.

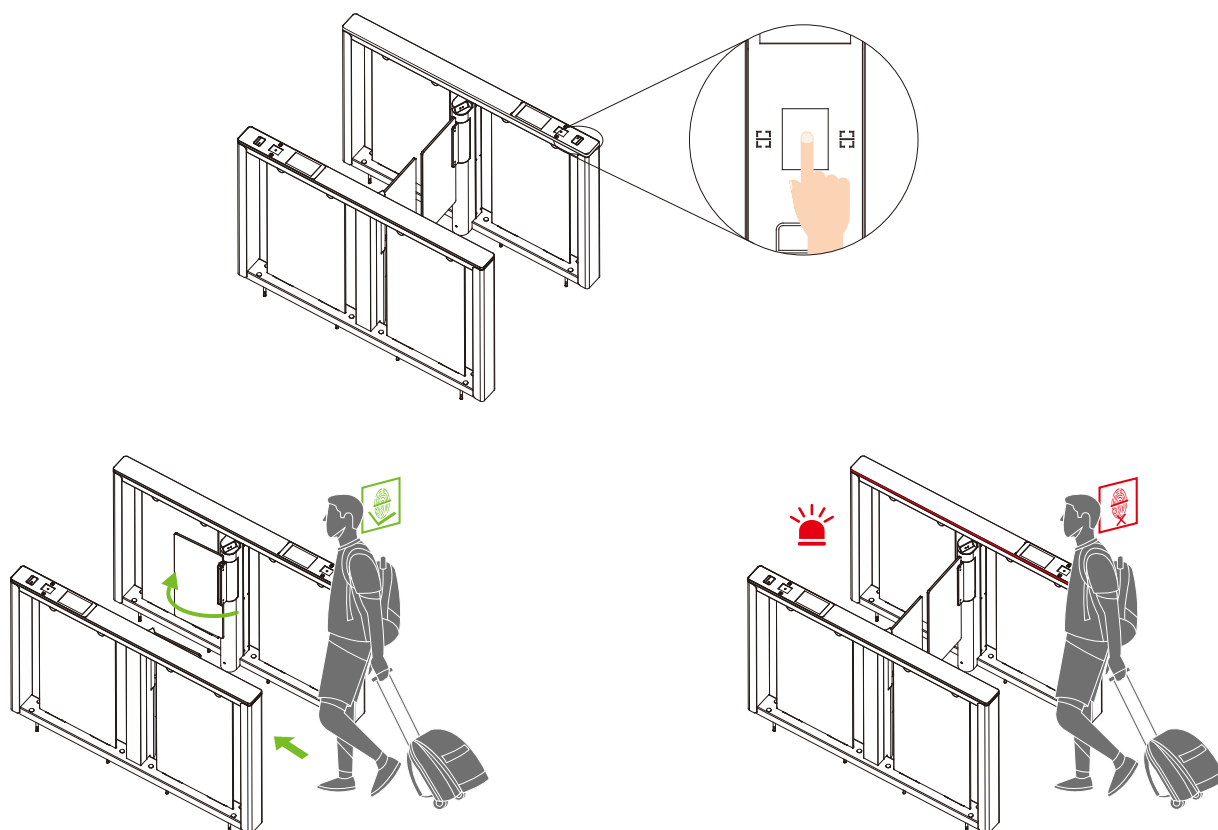

Recommended fingers: It is recommended to use the index, middle, or ring finger for registration and avoid using the thumb or little finger, as they are difficult to accurately press onto the fingerprint reader.

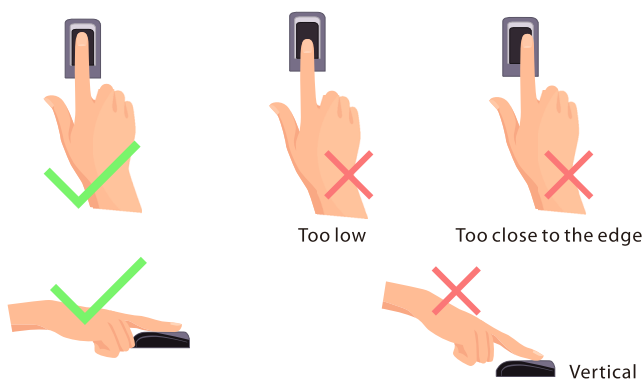

Note: Please ensure that you use the correct method when pressing your fingers onto the fingerprint reader for registration and identification. It is important to follow the proper guidelines to avoid any recognition issues. Please note that our company will not be liable for any recognition issues that may arise from incorrect usage of the product. We reserve the right to make the final interpretation and modifications of this matter.

2.2 Card Verification

In the Card Verification mode, the device compares the card number in the card induction area with all the card number data registered in the device and sends it to the Access Controller.

When a user presses their card on the card reading area, the device enters card authentication mode.

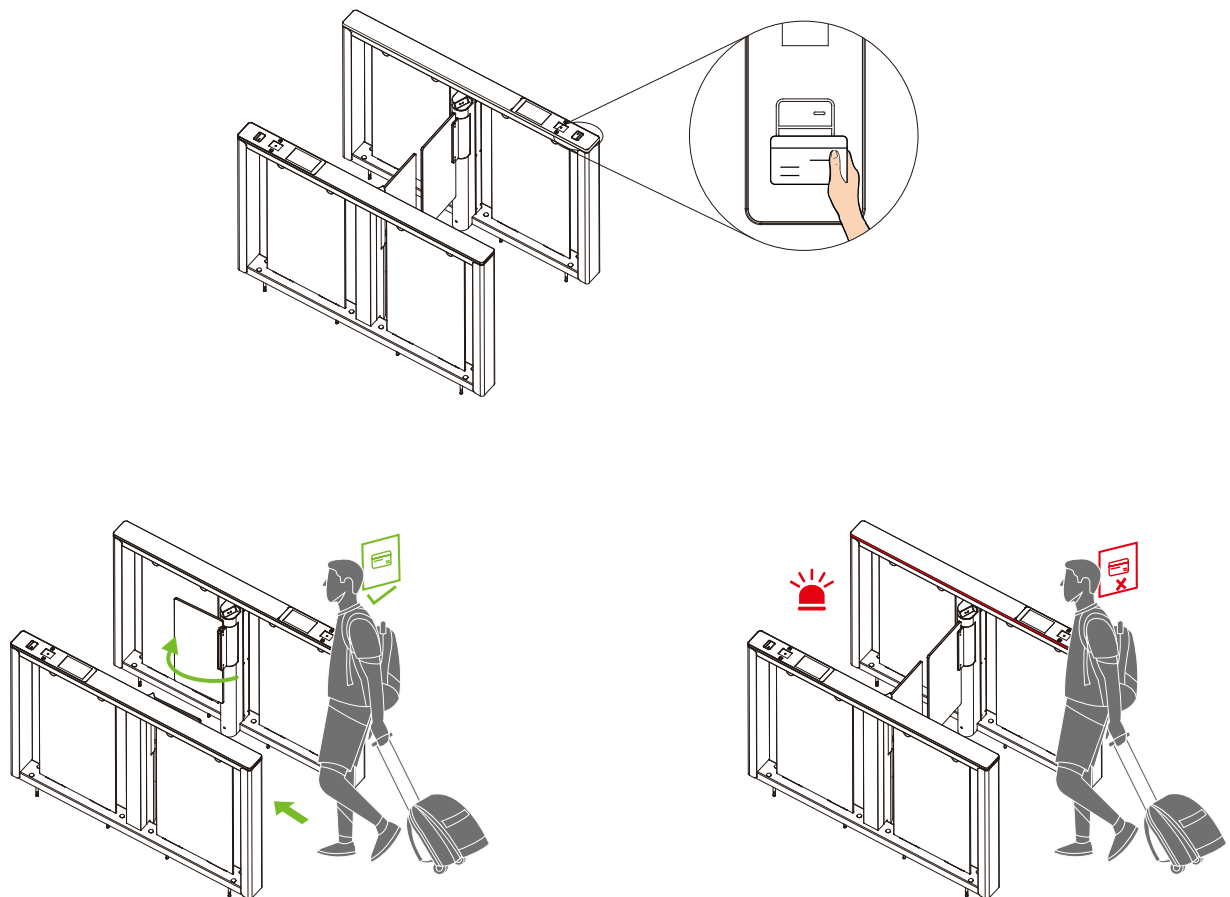

2.3 QR Code Verification

In the QR code Verification mode, the device scans the QR code on the user's mobile phone using the QR code scanner. It then compares the scanned data with the registered QR code and sends the result to the Access Controller.

When the user places the mobile phone displaying the QR code on top of the QR code scanner, the device enters the QR code authentication mode.

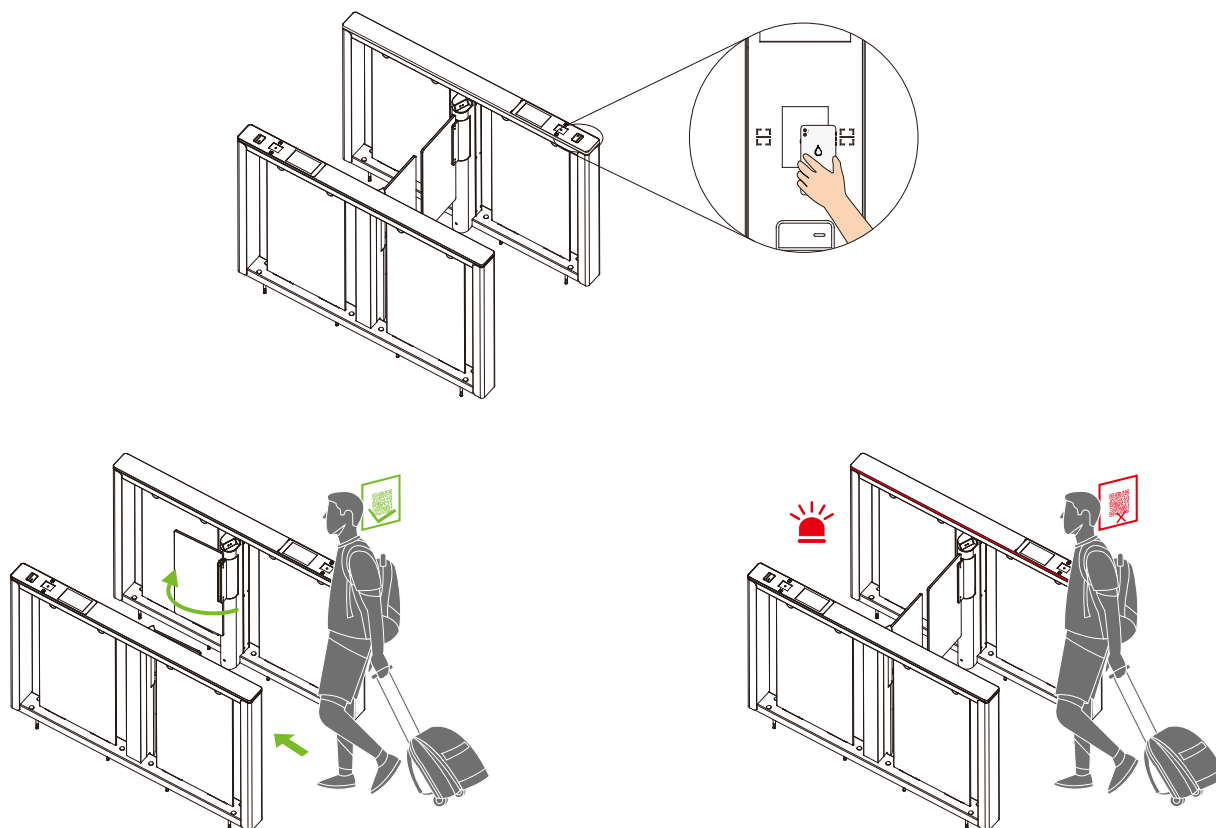

2.4 Palm Verification★

This verification mode compares the palm image collected by the palm module with all the palm data templates in the device and sends it to the Access Controller. When the user places his/her palm 20 to 50cm above the palm scanner, the device enters the palm verification mode.

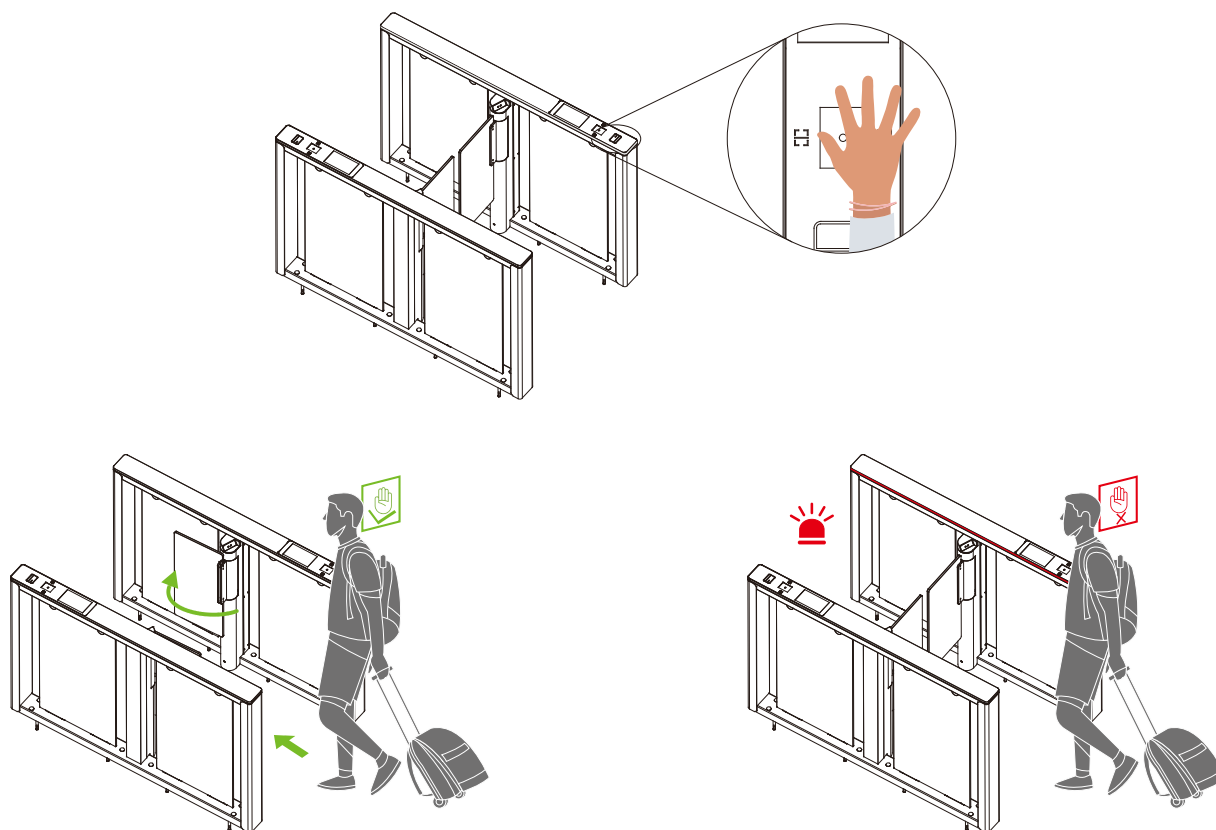
**Note:**

1. Place your palm within 20 to 50 cm of the device.
2. Place your palm in the palm collection area, such that the palm is placed parallel to the device.
3. Make sure to keep space between your fingers.

2.5 Facial Verification★

In this verification mode, the device compares the collected facial images with all registered face data in the device and then sends it to the Access Controller.

Please try to keep your face centered on the screen during authentication. When registering your face, ensure that you face toward the camera and remain still.

Recommended Standing Posture and Facial Expression:



Note: Please keep your facial expression and standing posture natural while enrollment or verification.

Recommended Distance and Angle for Facial Recognition:

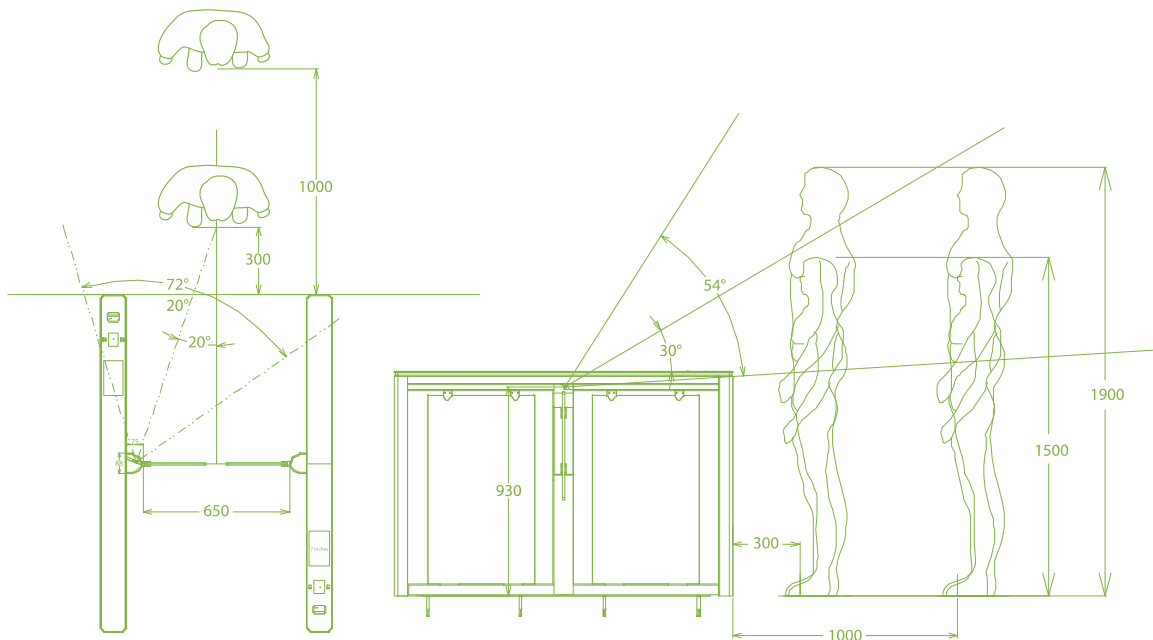

(mm)

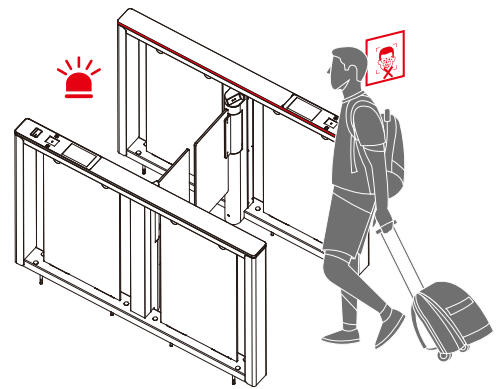
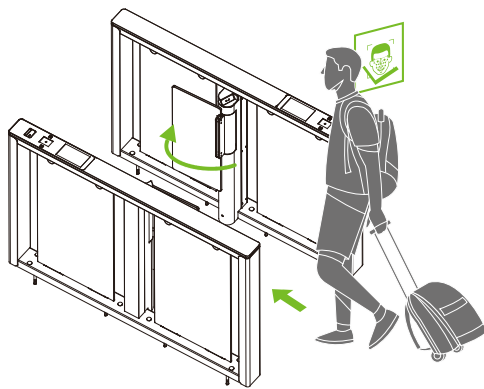





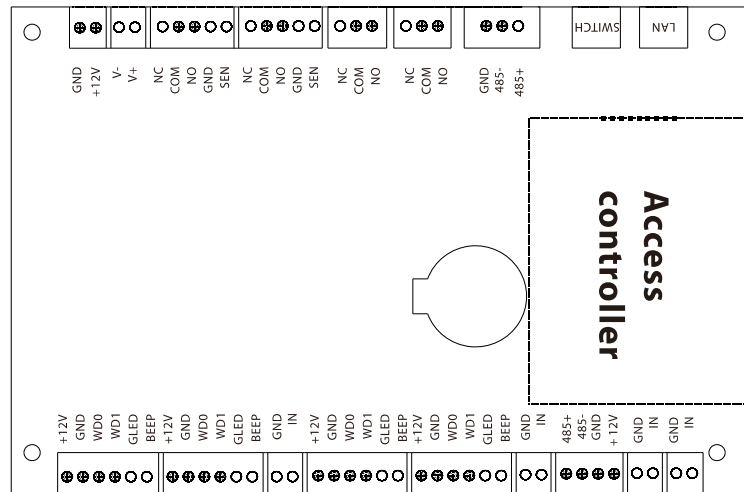

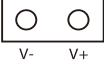
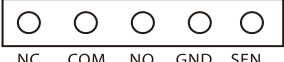

3 Control System Introduction

3.1 Access Control Board★



| Terminal | Description |
|----------|-----------------|
| | Reader |
| | Reader |
| | Button |
| | Reader |
| | Reader |
| | Button |
| | RS485 |
| | Auxiliary Input |

| | |
|---|------------------|
|  | Auxiliary Input |
|  | Power In |
|  | Lock |
|  | Lock |
|  | Lock |
|  | Auxiliary Output |
|  | Auxiliary Output |
|  | 485 Connections |
|  | Switch |
|  | Ethernet |

3.2 Master Motor Driving Controller Board

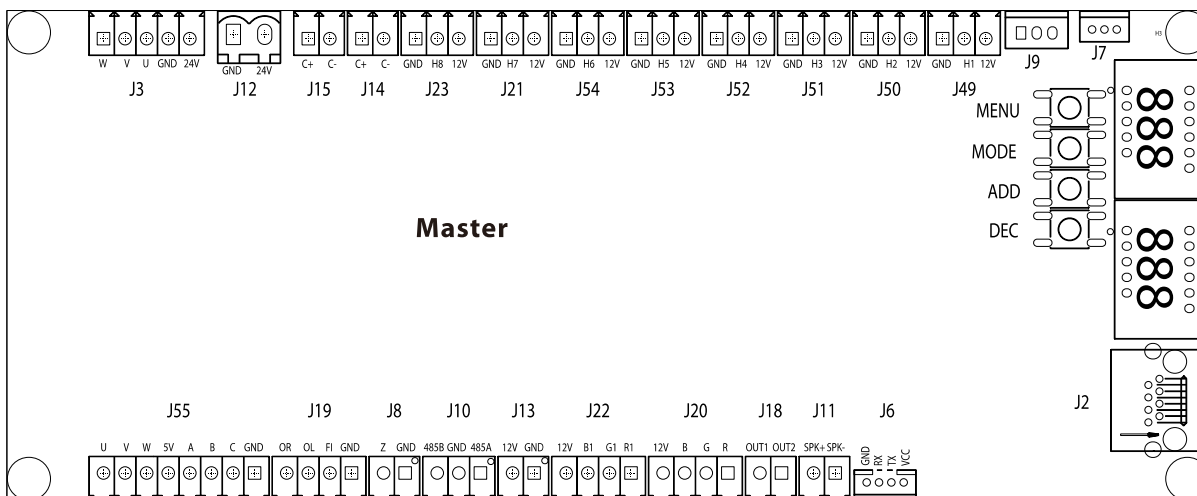

There are 4 keys on the master motor driving controller, "MENU", "MODE", "ADD" and "DEC".







MENU: Used to access the Settings menu and confirm modified values



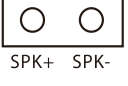
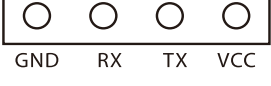

MODE: Returns to the previous menu and cancels the current operation.

ADD: Navigate to the upper menu item and increase the value.

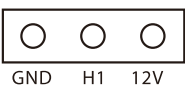
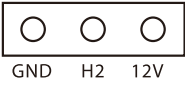
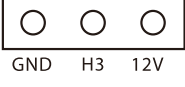
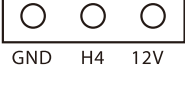
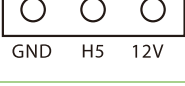
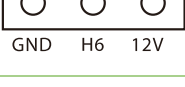
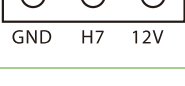
DEC: Navigate to the lower menu item and decrease the value.

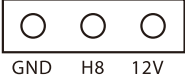

| Terminal | No. | Description |
|----------|-----|---------------------------------------|
| | J55 | Motor |
| | J19 | Open Input and Firefighting Interface |
| | J8 | Reserved |
| | J10 | RS485 |
| | J13 | Power in |

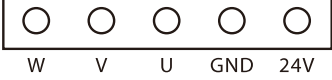



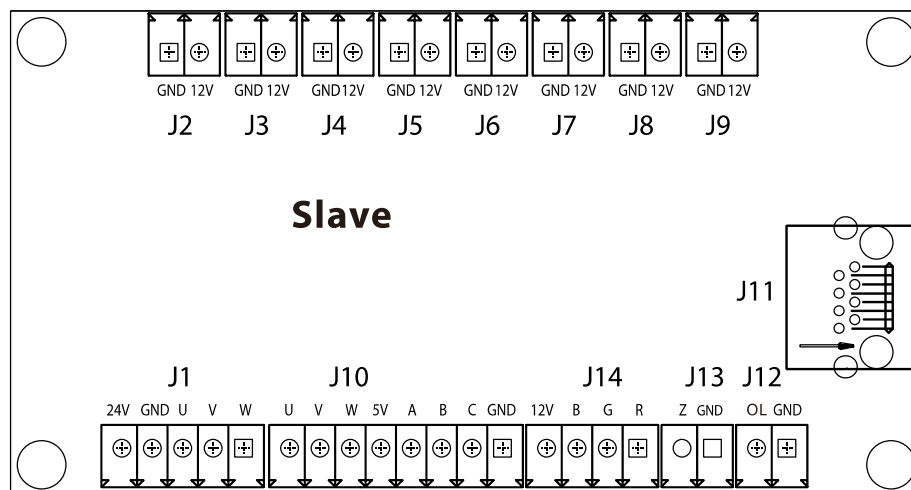





| | | |
|---|-----|--------------------------|
|  | J22 | Indicator light |
|  | J20 | Indicator light |
|  | J18 | Reserved |
|  | J11 | Speaker |
|  | J6 | RS232 communication |
|  | J2 | Ethernet/POE interface |
|  | J7 | IR sensor receiving port |
|  | J9 | Reserved |
|  | J49 | IR sensor receiving port |
|  | J50 | IR sensor receiving port |
|  | J51 | IR sensor receiving port |
|  | J52 | IR sensor receiving port |
|  | J53 | IR sensor receiving port |
|  | J54 | IR sensor receiving port |
|  | J21 | IR sensor receiving port |

| | | |
|---|-----|--------------------------|
|  | J23 | IR sensor receiving port |
|  | J14 | Clutch |
|  | J15 | Clutch |
|  | J12 | 24V DC power supply |
|  | J3 | Motor line |

3.3 Slave Motor Driving Controller Board

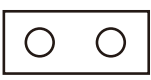
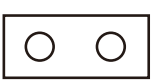

| Terminal | No. | Description |
|---|-----|-----------------|
|  | J1 | Motor line |
|  | J10 | Motor |
|  | J14 | Indicator light |

| | | |
|---|-----|-----------------------------------|
|  | J13 | Reserved |
|  | J12 | Open Input |
|  | J11 | Ethernet/POE interface |
|  | J9 | Infrared sensor transmitting port |
|  | J8 | Infrared sensor transmitting port |
|  | J7 | Infrared sensor transmitting port |
|  | J6 | Infrared sensor transmitting port |
|  | J5 | Infrared sensor transmitting port |
|  | J4 | Infrared sensor transmitting port |
|  | J3 | Infrared sensor transmitting port |
|  | J2 | Infrared sensor transmitting port |

3.4 Light Curtain Control Board

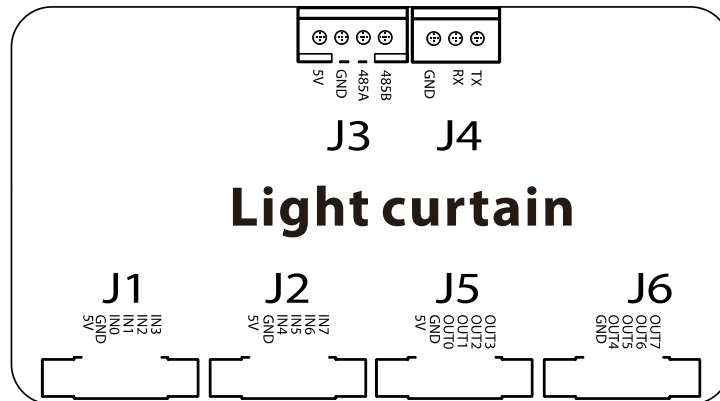

| Terminal | No. | Description |
|----------|-----|-----------------------------------|
| | J1 | Reserved |
| | J2 | Reserved |
| | J5 | Reserved |
| | J6 | Reserved |
| | J3 | RS485 |
| | J4 | Infrared sensor transmitting port |

3.5 Light Control Board

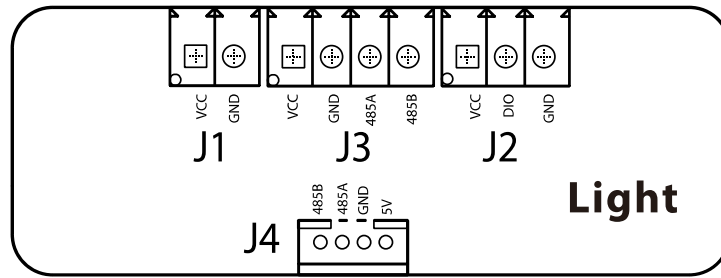

| Terminal | No. | Description |
|--------------------------------------|-----|--------------------|
| <p>485B 485A GND 5V</p> | J4 | RS485 |
| <p>VCC DIO GND</p> | J2 | Indicator light |
| <p>VCC GND 485A 485B</p> | J3 | Indicator light |
| <p>VCC GND</p> | J1 | 5V DC power supply |

3.6 Wiring Diagram

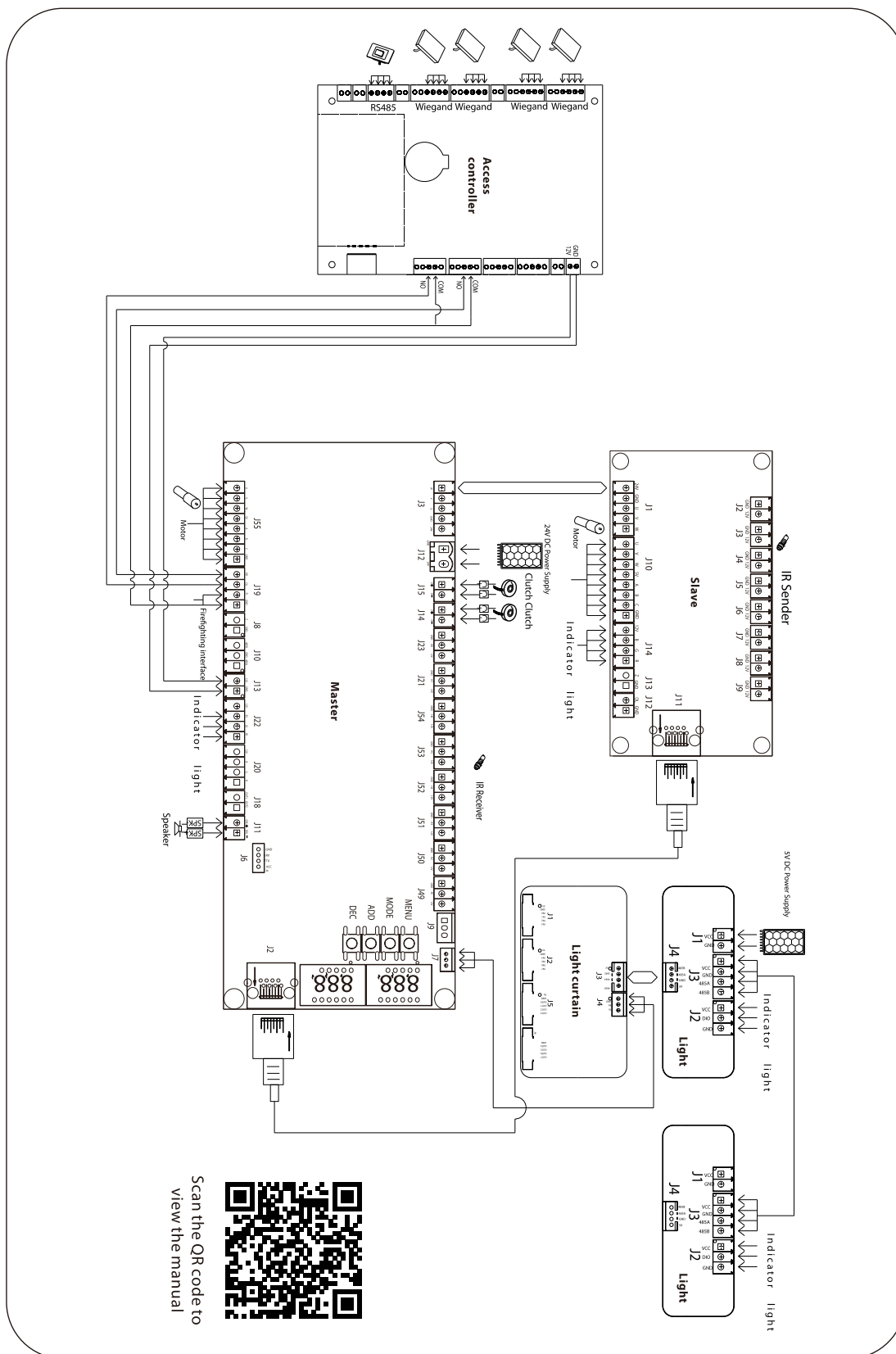

3.7 Menu of Speed Gate

Display Mode (01EXXX)

- (01E000) Displays current position of the gate
- (01E001) Infrared input signal
- (01E002) Controls input signal
- (01E003) Test mode (the digital LED displays "---" in the test mode)
- (01E004) Version number (Default)
- (01E005) Master Hall, slave Hall
- (01E006) Slave position
- (01E007) Light curtain infrared status

Opening Mode Setting (02EXXX)

- (02E001) Two-way controlled, both need verification (Default).

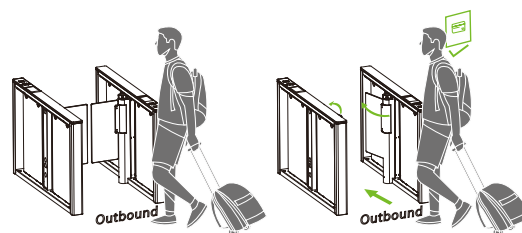
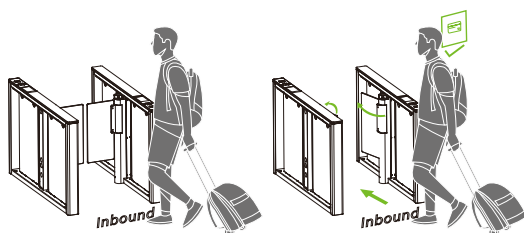

- (02E002) In need verification, out free.

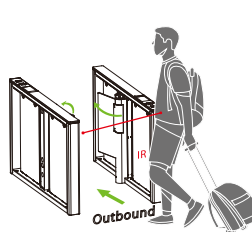
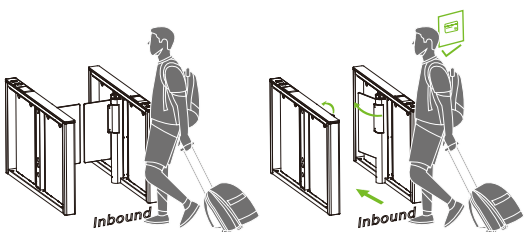

- (02E003) In free, out need verification.

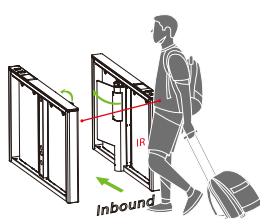

- (02E004) Two-way free.

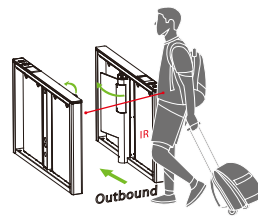
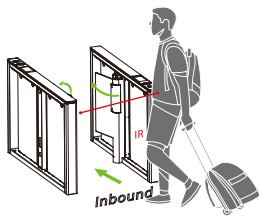

- (02E005) In need verification, out prohibited.

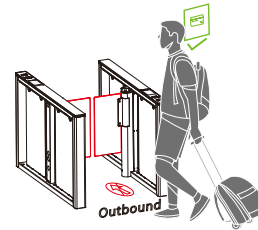
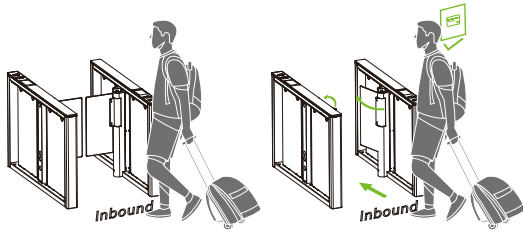

- (02E006) In prohibited, out need verification.

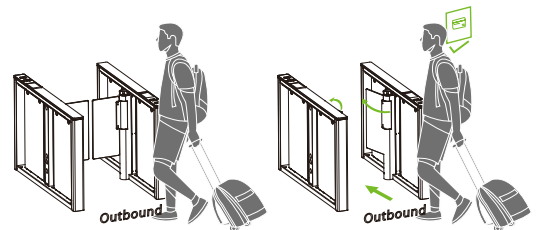
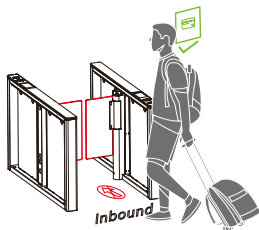

- (02E007) In free, out prohibited.

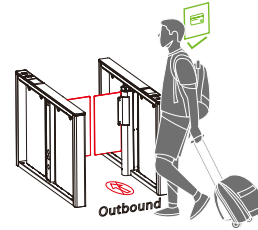
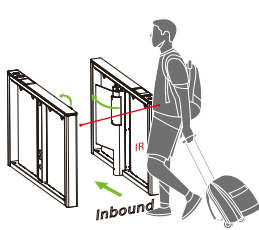

- (02E008) In prohibited, out free.

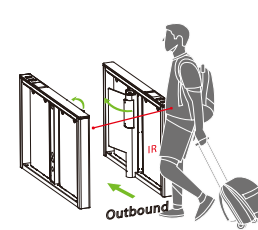
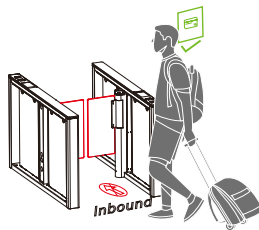

- (02E009) Two-way prohibited.

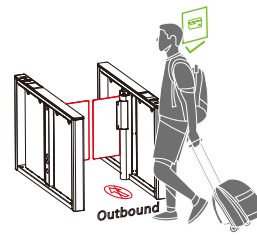
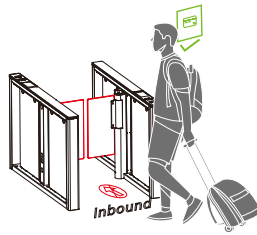

- (02E010) Two-way normally open.

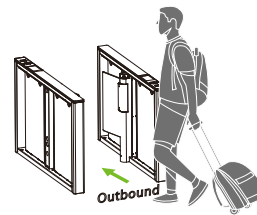
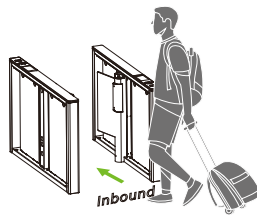

Gate Opening Speed (03EXXX)

To adjust the gate opening speed, you can set a larger number for a faster opening. The Gate Opening Speed can be configured between 5 and 30, with a default value of 22.

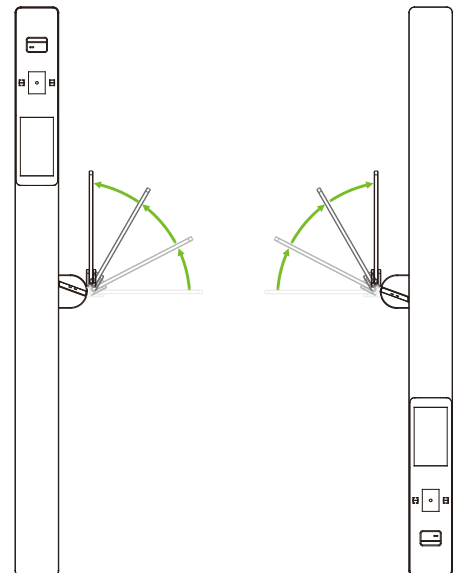
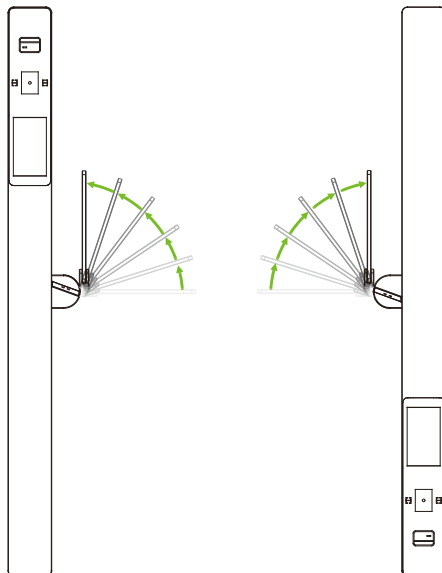
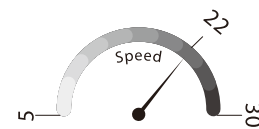
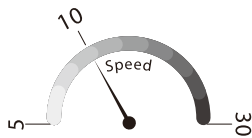

Gate Opening Deceleration Distance (04EXXX)

A larger number increases the deceleration time, enhancing the stability of the swing arm operation. The Gate Opening Deceleration Distance can be set between 0 and 50, with a default value of 15.

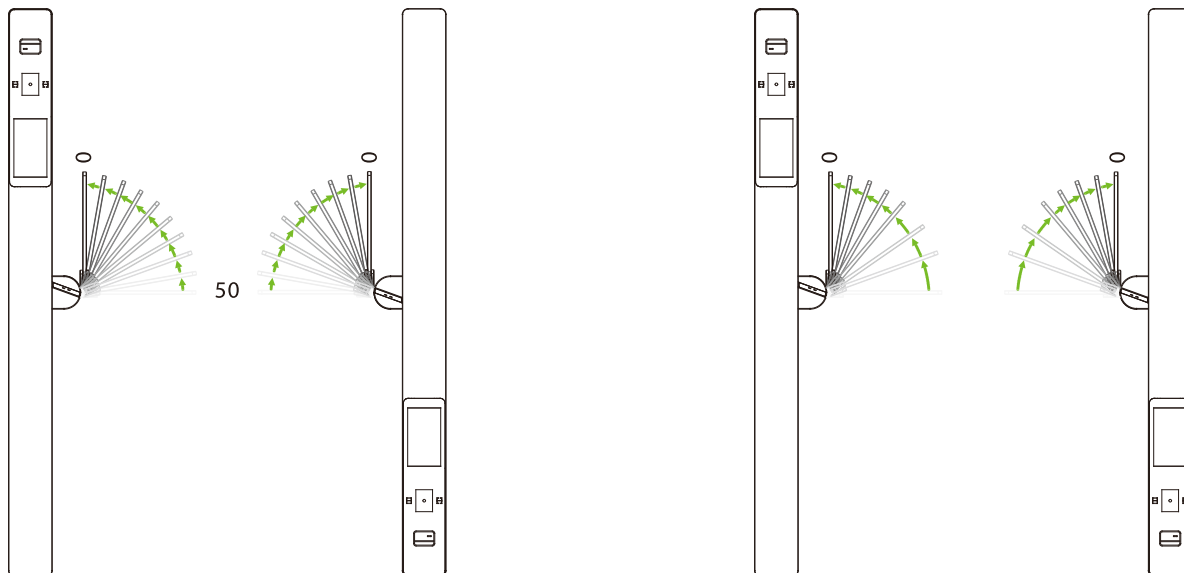

Gate Opening Compensation Speed (05EXXX)

This setting is used when the swing arm cannot fully open or shakes during operation. A larger number results in faster compensation speed. The Gate Opening Compensation Speed can be set between 0 and 50, with a default value of 20.

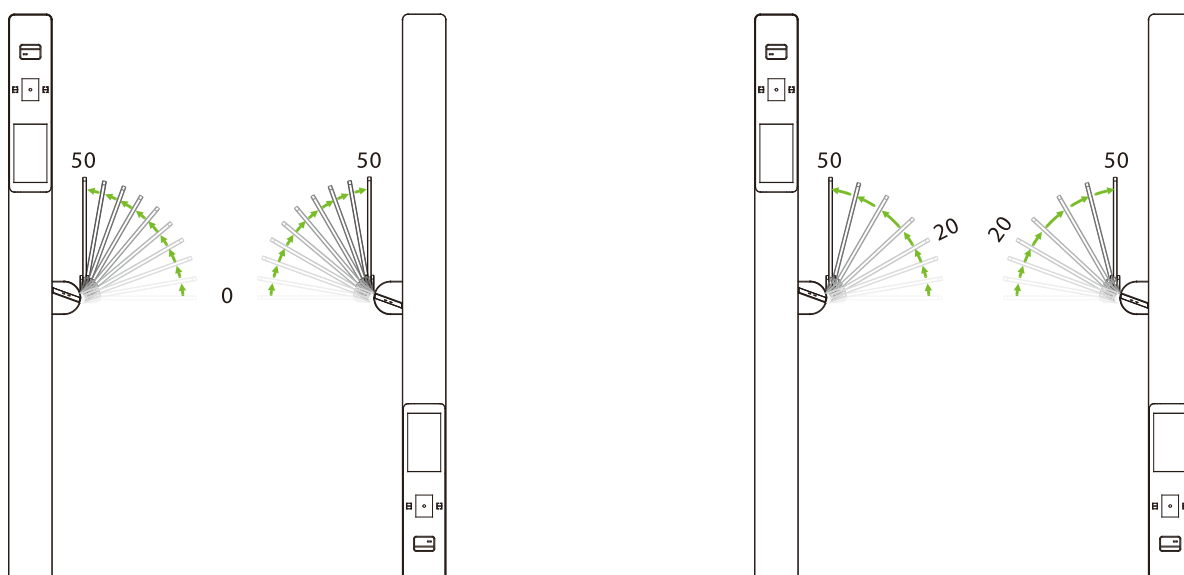

Infrared Quantity Selection (06EXXX)

Choose the number of pairs of infrared sensors to apply to the device. The normal infrared mode supports a maximum of 8 pairs. If more than 8 pairs are needed, it switches to light curtain mode, requiring the corresponding configuration of the light curtain board.

Note: After selecting the number of logical infrared pairs, the available infrared interfaces are equipped with anti-pinch functionality.

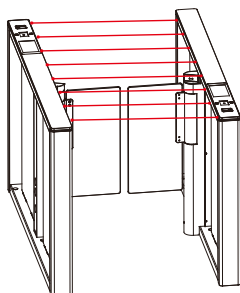

Master Position Adjustment (07EXXX)

1. Adjust the position only when Comet the series is installed properly.
2. During zero position setup, you can manually adjust the swing arm for fine-tuning. If the barrier exceeds a specific angle, the adjustment becomes invalid (indicated by a digital LED displaying 07E000).

Swing Barrier

- (07E001) Zero position
- (07E002) Right position
- (07E003) Left position

Flap Barrier

- (07E001) Zero position
- (07E002) Open position

Slave Position Adjustment (08EXXX)

- (08E001) Zero position
- (08E002) Right position
- (08E003) Left position

Motor Type Selection (09EXXX)

Choose the motor type, which can be set from 0 to 4. Please ensure to set the motor type of this turnstile accurately according to the actual product.

- (09E000) L-shaped swing barrier
- (09E001) Flap barrier
- (09E002) Speed gate
- (09E003) Integrated planetary motors
- (09E004) Split planetary motors

RS485 Address (10EXXX)

It can be set between 0 to 254 and the default value is 0.

Open Duration Time (11EXXX)

The valid time period after a successful verification can be configured. Once the set time is reached, the gate will automatically close. The longer the number set, the longer the valid time. The valid value ranges from 2 to 60 seconds, with a default value of 5 seconds.

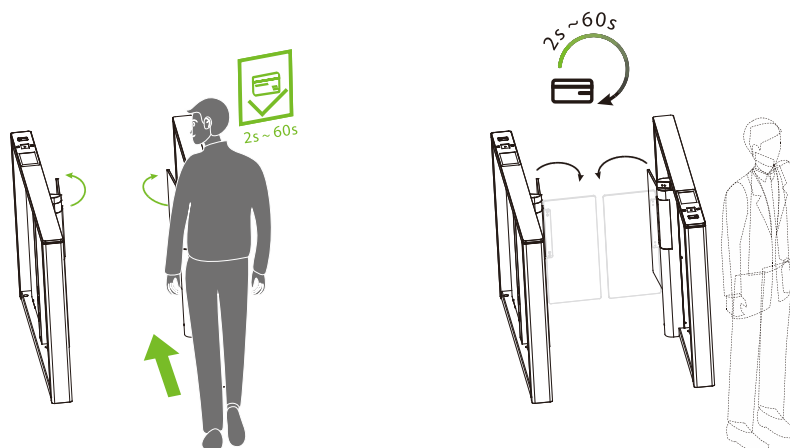

Gate Closing Delay Time (12EXXX)

Set the delay time of gate closing after passing. The valid value for gate closing delay time can be set between 0 to 60s and the default value is 0s.

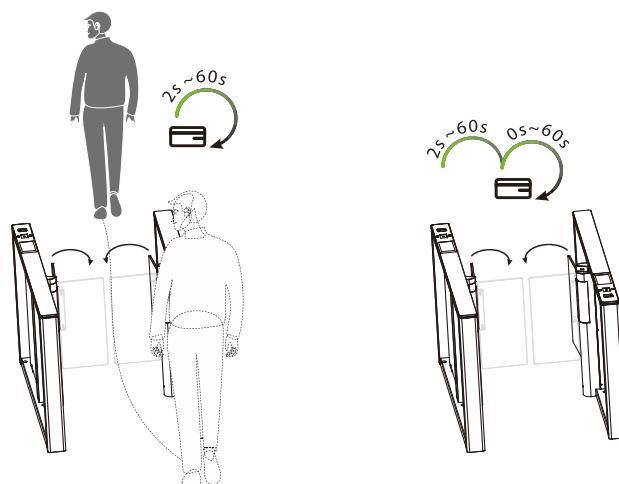

Movement Replacement (13EXXX)

The master motor board is designed to accommodate different turnstiles, and the turnstiles vary in the type of movement.

- (13E000) Swing barrier A (Swing barrier)
- (13E001) Swing barrier B (Swing barrier)
- (13E002) AA (Speed gate)
- (13E003) BB (Flap barrier in the International Zone)
- (13E004) AB (Flap barrier for China)
- (13E005) BA (Flap barrier for China)

Gate Opening Memory (14EXXX)

When more than two legal access signals are given at the same time (including the same direction and the opposite direction), the system will remember all pass requests and complete each pass in turn.

- (14E000) Close (Default)
- (14E001) Open

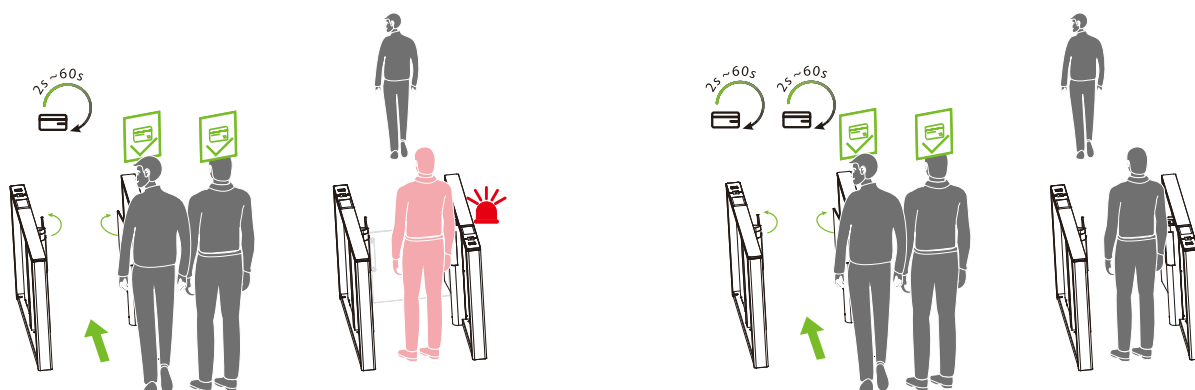

Authentication in Lane (15EXXX)

It allows pedestrian verification during the IR sensor triggered.

- (15E000) Allow (Default)
- (15E001) Forbidden

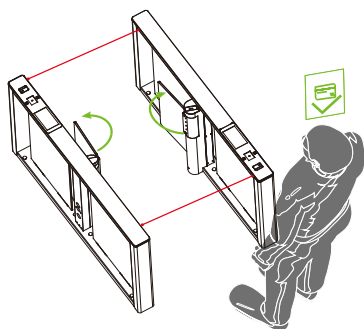

Normal mode

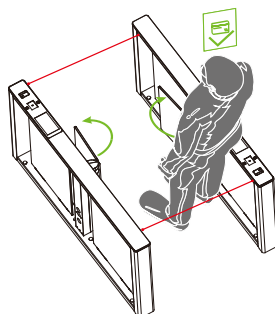

Allow authentication in lane

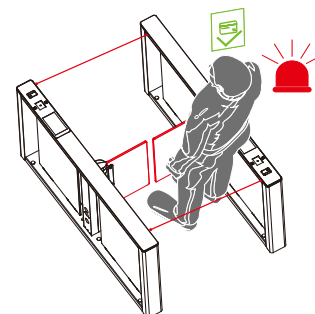

Forbidden authentication in lane

Volume Setting (16EXXX)

Volume Setting is used for adjusting the volume of the device. The larger the number is set, the louder the volume. The valid value for Volume Setting can be set between 1 to 100 and the default value is 70.

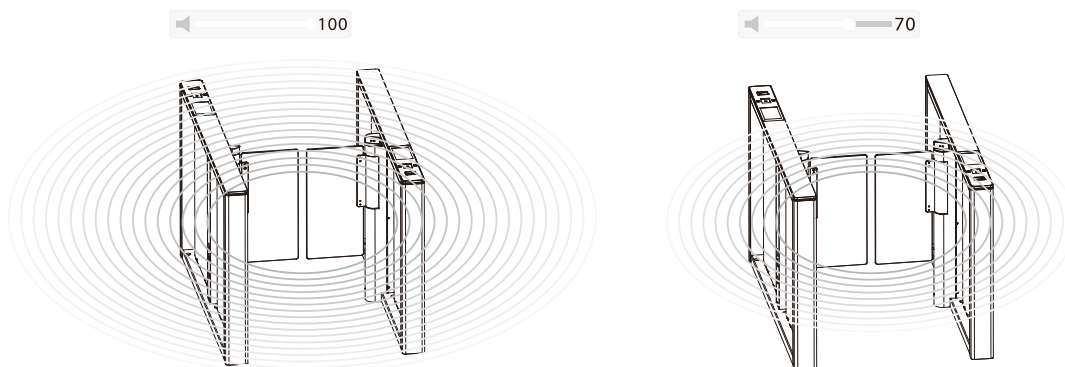

Close Alarm Tone (17EXXX)

When the alarm tone is turned off, the Turnstile will not emit an alarm tone when encountering an alarm situation. The following figure shows an example of the prohibition of authentication in lane:

- (17E000) Close
- (17E001) Open (Default)

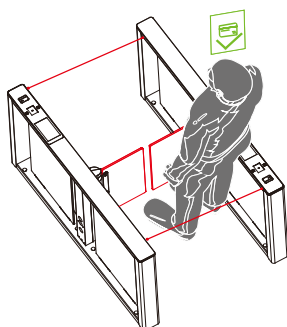

Close Alarm Tone

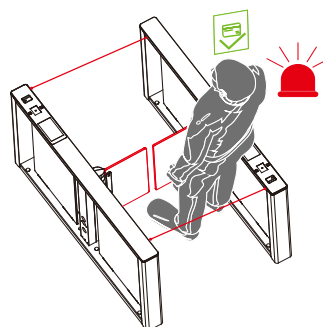

Open Alarm Tone

Bluetooth Switch (18EXXX)

Turn on the Bluetooth function to facilitate the device to connect to the cell phone software to use. For security reasons, Bluetooth will be turned off automatically if it is still not successfully connected to the cell phone software after 50 seconds of Bluetooth being turned on.

- (18E000) Close
- (18E001) Open

Stay Duration Time (19EXXX)

Set the duration of stay in the channel after successful verification. The valid value for Stay Duration Time can be set between 5 to 30 seconds and the default value is 10s.

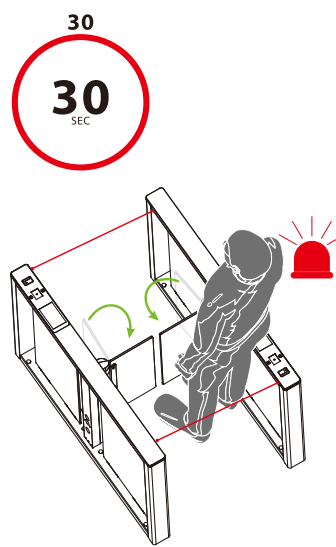
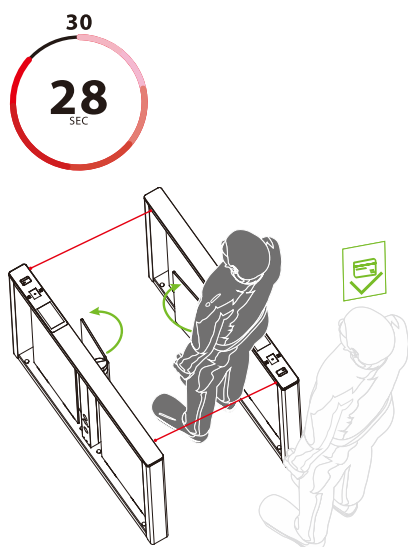

Force Adjustment (20EXXX)

The larger the number, the greater the efficiency of the gate opening and closing force. The valid value for Force Adjustment can be set between 10 to 60 and the default value is 40.

Fire Opening Direction (21EXXX)

According to the external fire device, select the corresponding type of trigger mode.

- (21E000) Entry direction (Default)
- (21E001) Exit direction

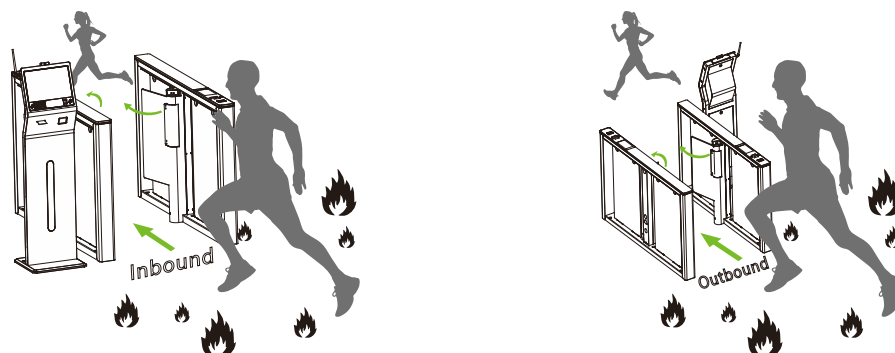

Clutch Locking Stroke (22EXXX)

Set the angle at which the clutch starts. The larger the number, the bigger the angle. The valid value for Clutch Locking Stroke can be set between 0 to 99, and the default value is 0. When setting it to 0 do not lock it, adapting it to movements without a clutch.

Clutch Locking Mode (23EXXX)

When the gate is unlocked in an unauthorized way, the clutch gets locked automatically. The Clutch Locking Mode can be set as:

- (23E000) Automatic unlock (Default)
- (23E001) Authentication to unlock.



Restore Factory Setting (24EXXX)

- (24E001) Restore factory settings.
- (24E002) Restart the device.

Anti-pinch Area Setting (25EXXX)

- (25E000) All Infrared anti-pinch (Default)
- (25E001) First and last pair are not anti-pinch.

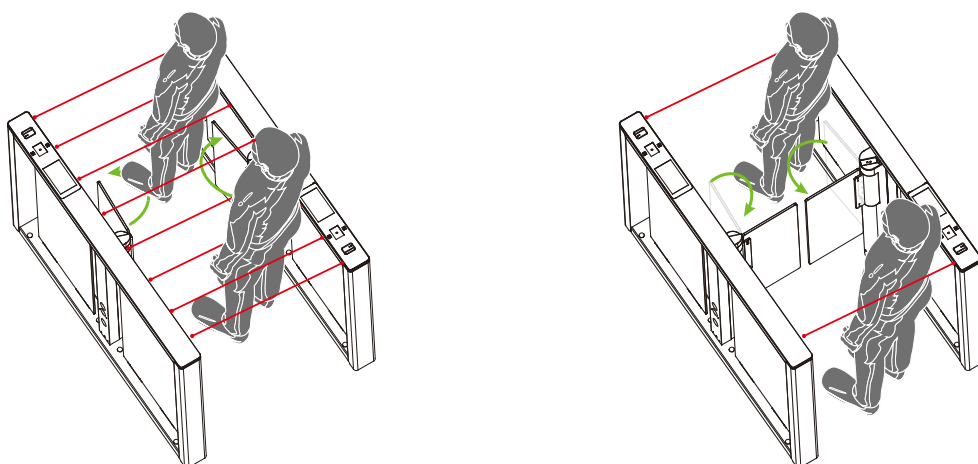

False Direction Entry (26EXXX)

When the Anti-pinch Area Setting needs to be set to (25E001) only, the False Direction Entry (26E000) is effective.

- (26E000) Close (For flap barrier)
- (26E001) Only alarm (Default)
- (26E002) No detection

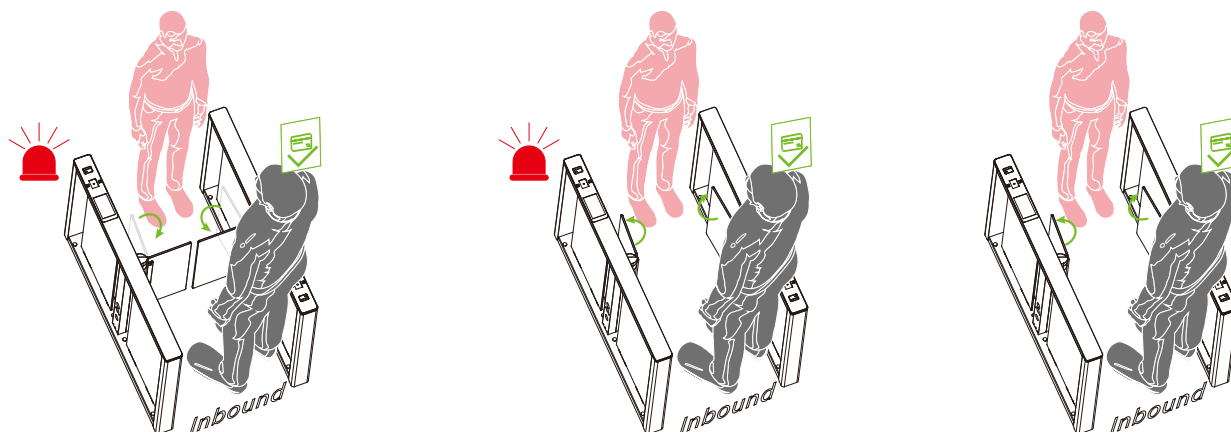

Anti-tailgate Setting (27EXXX)

When the Anti-pinch Area Setting needs to be set to (25E001) only, the Anti-tailgate Setting (27E000) is effective.

- (27E000) Close (For flap barrier)
- (27E001) Only alarm (Default)
- (27E002) No detection

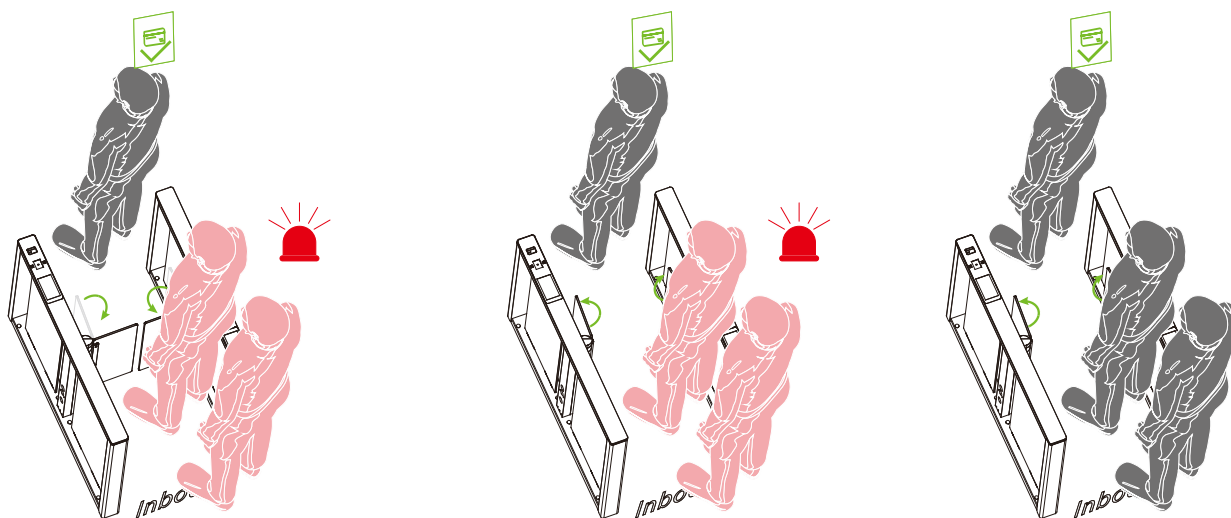

Gate Closing Position (28EXXX)

When the Anti-pinch Area Setting needs to be set to (25E001) only, the Gate Closing Position (28E001) is effective.

- (28E000) Last pair (Default)
- (28E001) Penultimate pair

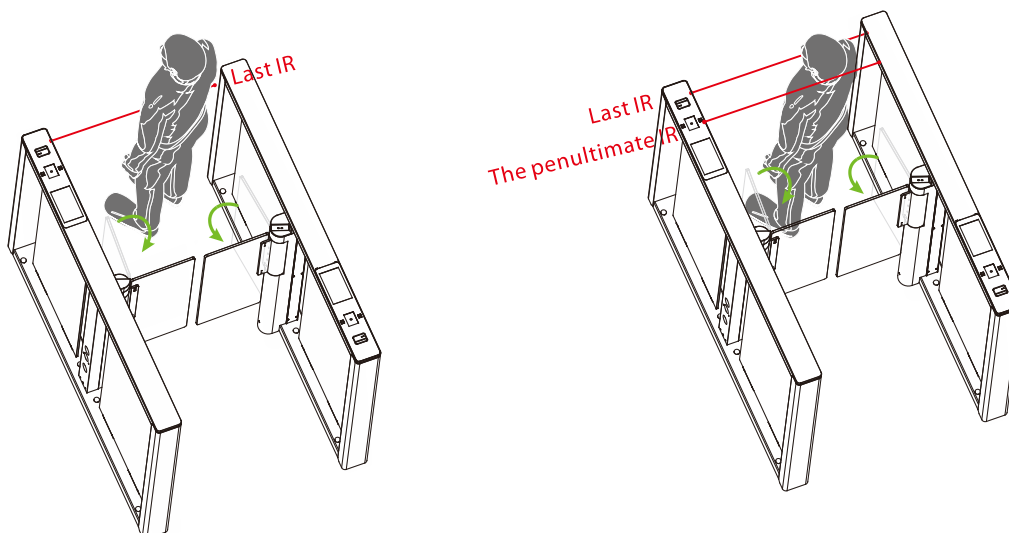

Anti-pinch Action Setting (29EXXX)

- (29E000) Stop (Default)
- (29E001) Open
- (29E002) Close the function

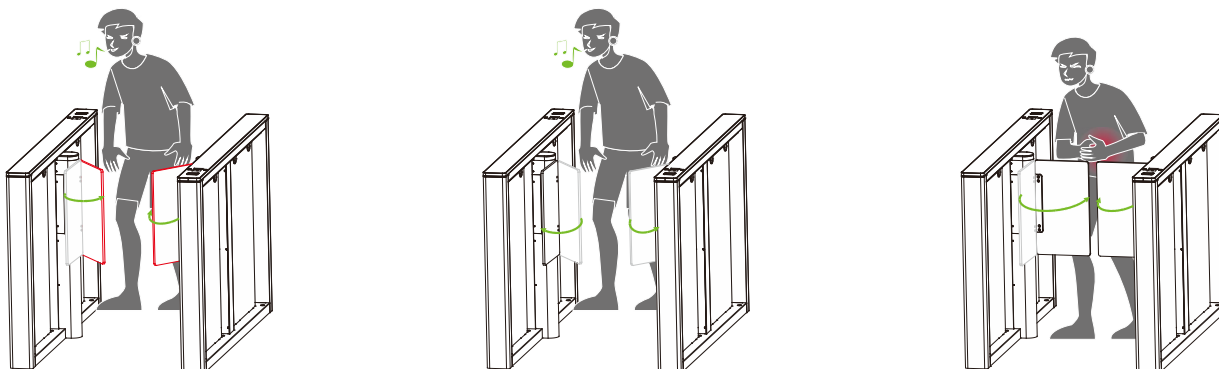

Voice Switching (30EXXX)

Sets whether the device announces a voice or an alarm tone.

- (30E000) Voice playback

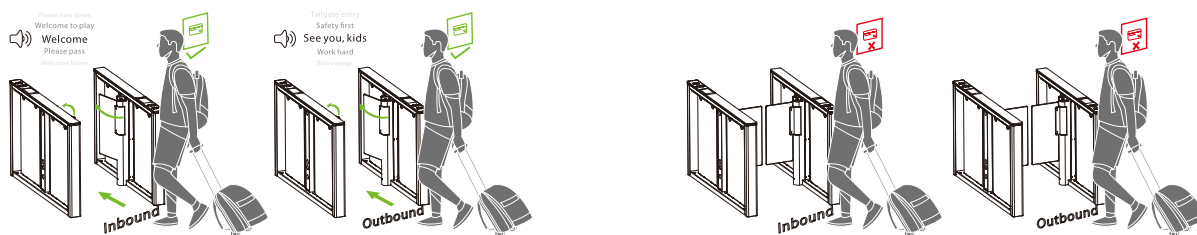

- (30E001) Alarm tone (Default)

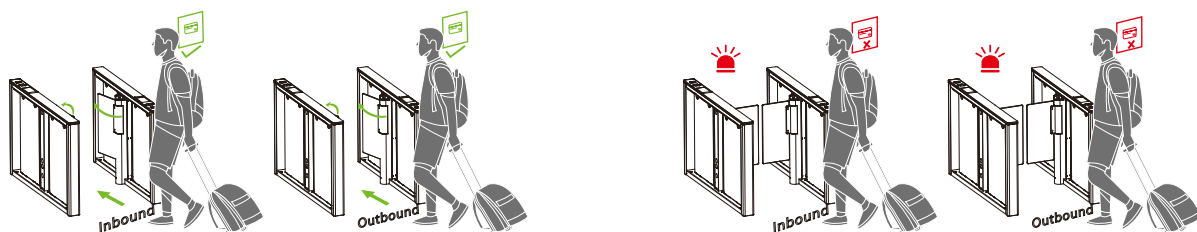

Swing Arm Type (31EXXX)

- (31E000) Ordinary swing arm (Default)
- (31E001) Larger swing arm

- (31E002) Ultra swing arm

Right Synchronous Adjustment (32EXXX)

You can adjust the synchronization of the Master through this menu, the larger the value, the faster the response of the Master to open the gate, the setting range lies between 30 to 200, and the default value is 100.

Left Synchronous Adjustment (33EXXX)

You can adjust the synchronization of the Slave through this menu, the larger the value, the faster the response of the Slave to open the gate, the setting range lies between 30 to 200, and the default value is 100.

Entrance Direction Voice (34EXXX)

Select the voice to enter the direction, the setting range lies between 0 to 60, and the default value is 0.

Exit Direction Voice (35EXXX)

Select the voice to exit the direction, the setting range lies between 0 to 60, and the default value is 17.

Zero Position Strength Adjustment (36EXXX)

Set the strength of the swing arm to return to the zero position, the larger the value, the stronger the strength, the valid value of the zero position strength adjustment is 1 to 10, and the default value is 2.

Standby Colour (37EXXX)

An embedded LED strip is situated along the barrier's side, offering a spectrum of 7 RGB colors and a range of visual effects. This feature is fully customizable to meet our customer's unique preferences.

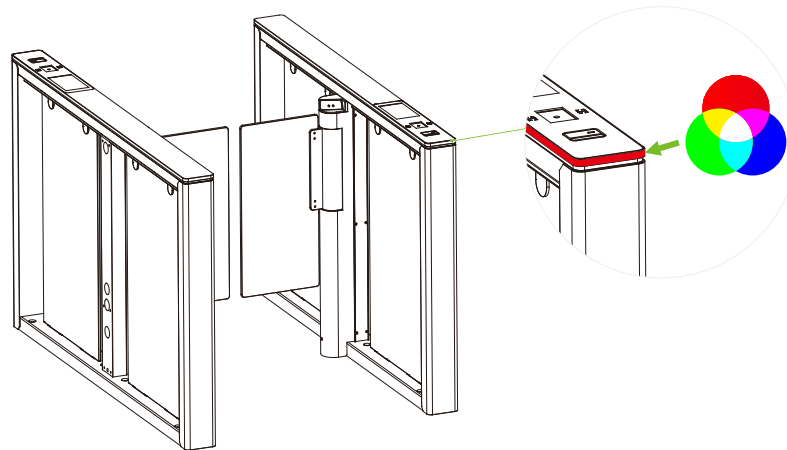

3.8 Voice Playback Content Correspondence Table

| Item | Voice Content | | |
|--------------------------------------|--------------------------------|------|-----------|
| Control board program failure | System failure! | 0001 | Not valid |
| Inbound verification passed | Welcome! | 0060 | Valid |
| | Welcome home! | 0061 | Valid |
| | Peace be with you! | 0062 | Valid |
| | I wish you good health! | 0063 | Valid |
| | Please pass! | 0064 | Valid |
| | We welcome your patronage! | 0065 | Valid |
| | Please be safe! | 0066 | Valid |
| | Welcome to play! | 0067 | Valid |
| | Have a nice trip! | 0068 | Valid |
| | Please slow down! | 0069 | Valid |
| | Be safe, please wear a helmet! | 0070 | Valid |

| | | | |
|---|---|------|-----------|
| | Successful registration and good luck! | 0071 | Valid |
| | Welcome home, and have a good trip! | 0072 | Valid |
| | Ticket checks approved. Welcome aboard! | 0073 | Valid |
| | Get to work safely and get home safely! | 0074 | Valid |
| | Please pass in order! | 0075 | Valid |
| | "Dong" | 0076 | Valid |
| Outbound Verification passed | Bon voyage! | 0080 | Valid |
| | Welcome to the next visit! | 0081 | Valid |
| | Safety first | 0086 | Valid |
| | Work hard! | 0087 | Valid |
| | See you, kids! | 0088 | Valid |
| | Please authenticate and pass! | 0004 | Not valid |
| | Tailgate entry! | 0014 | Not valid |
| False direction entry without authentication | False direction entry! | 0016 | Not valid |
| | Prohibited, please use other access! | 0007 | Not valid |
| Verify that the stay in the channel at the time of passage exceeds 5s! | Pass quickly and do not linger! | 0015 | Not valid |
| Illegal ramming of the swing arm | Forced entry, please be advised! | 0008 | Not valid |

| The following abnormal alarms | | |
|--------------------------------------|--|------|
| Please verify outside the channel | The device is set up to "Prohibit authentication in Lane ", and personnel entering the channel are prompted to exit the out-of-channel verification. | 0005 |
| System reboot in progress | System reboot prompts | 0006 |
| Fire switch activation | A fire signal is detected and the fire setting is executed. | 0011 |
| Infrared anomaly | Infrared anomaly detected | 0012 |
| Alarm tone 2 | Alarm tone playback in alarm status | 0031 |
| | Welcome | 0002 |
| | Bon voyage! | 0003 |
| | Out-of-channel card swipe | 0004 |
| | "Dong" | 0029 |
| | Break-in | 0009 |
| | Please reboot the system. | 0013 |
| | Please correct the zero position | 0017 |
| | 0030 Sound effect 1 | 0030 |

3.9 Error Code for Turnstile

| Error Code | Cause |
|---------------|--|
| ER0002 | Power-on Self-test failure, Hall Limit Detection Error |
| ER0004 | Run Timeout |
| ER0008 | Clutch Locked |
| ER016 | The code disk detection failed. |
| ER032 | Electric Motor Shaft Lock Protection failure |

4 Maintenance

4.1 Chassis Maintenance

The chassis is made of aluminum stainless steel or cold rolled sheet steel. If it has been used for a long time, the surface may have rust stains. Clean the surface thoroughly with a clean cloth regularly. Apply anti-rust oil on the surface, but do not cover the infrared sensor.

4.2 Movement Maintenance

Before performing maintenance, turn off the power. Open the door, wipe the surface dust, and apply lubricant for smooth movement.

4.3 Power Supply Maintenance

- Switch off the power supply before maintenance.
- Check the power plug connection, if found loose, fix it properly.
- Do not change any connection position randomly.
- Periodically check the insulation of the external power supply.
- Do periodic checks for any kind of leakage.
- Check if the technical parameters of the interface are normal.
- Check the service life of the electronic components and replace them accordingly.







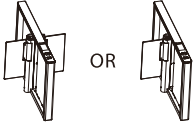

Caution: All maintenance procedures mentioned above for speed gates must be conducted by a professional technician, particularly for the movement and electric control components. To ensure operational safety, always switch off the power supply when the speed gate is not in use.

5 Troubleshooting

| No. | Failure Descriptions | Analysis and Solution |
|-----|--|---|
| 1 | The mode indicator light does not respond or the indication is incorrect. | Check that the control panel mode indicator wiring is correct or that the contact is poor. |
| 2 | After swiping the card, there is only a speed gate unlocked. | Check the mode setting of the master and slave devices and the 8-core, and 2-core connection lines. See the wiring diagram for the specific connection circuit. |
| 3 | The speed gate doesn't close when the opening delay time is ended. | Check to see if the opening delay time is too long or whether the IR sensor is covered. |
| 4 | When the gate is self-tested, the swing arm is not in the normal closing position! | In the process of self-test, there are obstacles, please remove the obstacles, and restart the self-test after power-on! |

6 Packing List

The package consists of the following items:

| | | |
|---|--------------------------------------|---|
|  | Comet-Series | 1 |
|  | Power Cable | 1 |
|  | Card | 1 |
|  | Expansion Screw M12*100 | 6 |
|  | Washer | 6 |
|  | Expansion Screw Washers | 6 |
|  | Stainless Steel Maintenance Wipes | 1 |
|  | Hex Wrench | 1 |

ZKTeco Industrial Park, No. 32, Industrial Road,

Tangxia Town, Dongguan, China.

Phone : +86 769 - 82109991

Fax : +86 755 - 89602394

www.zkteco.com

