

FaceKiosk Series User Manual

Version: 2.4

Date: 11/26/2018

Declaration

Thank you for choosing our product. Before using this product, read this manual carefully to use the software properly. Proper use will result in good effect and fast verification.

None of the content of this document shall be copied or delivered in any forms or by any means without the prior written consent of our company.

The product described in this manual may include the copyright software of the company and its possible licensors. No one shall copy, distribute, modify, extract, decompile, disassemble, decrypt, reverse engineer, rent, transfer, sublicense, or infringe the software copyright in any form, except that such limitations are prohibited by applicable laws.



Information provided in this manual may differ from actual technical specifications due to the constant development of products. Our company claims no responsibility for any disputes arising out of any discrepancy between actual technical parameters and those described in this document. The document is subject to change without prior notice.

Contents

1. Note	1
1.1. Configurations	1
1.2. Installation	1
1.2.1 Installation Environment	1
1.2.2 Installation Procedure	2
1.3. Precautions	4
1.4. Notes for Access Control Wiring	4
1.4.1 Access Control Interface	4
1.4.2 Connection with Lock	5
1.4.3 Wiegand Output Connection	6
1.4.4 Recommended Identification Distance	6
2. Check-in interface and Main Menu	6
3. Employee Management	9
4. Communication Settings	11
4.1 Wi-Fi Settings	11
4.2 Ethernet Settings	11
4.3 Server Settings	12
5. System Settings	13
5.1 Time and Date	13
5.2 Face Parameters	15
5.3 Attendance Parameters	16
5.4 Stranger Photo Save Function	17
5.5 Stranger Alarm Function	17
5.6 Blacklist Photo Save Function	17
5.7 Blacklist Alarm Function	18
5.8 QR Code Setting	18
6. Data Management	19
6.1 Delete Data	19
6.2 Backup Data	20
6.3 Restore Data	20
7. U Disk Management	21
7.1 Uploading Data over a USB Drive	21
7.2 Downloading Data over a USB Drive	22
8. Record Search	22

8.1 Attendance Record and Photo Search	23
8.2 Meeting Information	24
8.3 Stranger Photo	24
8.4 Blacklist Photo.....	25
9. System Information	26
10. Advertisement Setting.....	26
11. Personal	28
12. Access Control Management.....	30
12.1 Access Control Parameters	30
12.2 Wiegand Output Setting.....	31
13. BioTime 7.0 Connection.....	32
13.1 Adding a Device	32
13.2 User Management	33
13.2.1 Adding a User	33
13.3 Attendance Management	33
14. ZKBiosecurity Connection	34
14.1 Adding a Device	34
14.2 User Management	35
14.2.1 Adding a User	35
14.2.2 Uploading a Photo	36
14.2.3 Importing User Information in Batches	37
14.2.4 Importing User Photos in Batches	38
14.3 Adding Advertisement.....	39
14.3.1 Add Advertising Pictures	39
14.3.2 Add AD Video.....	40
14.3.3 Advertisement Settings	40
14.4 Attendance Management	42
14.5 Scan Code Registration.....	42

1. Note

This user manual is applicable for 21.5-inch, 32-inch and 43-inch FaceKiosk series device. The content of this manual includes the UI display of 43-inch FaceKiosk as an example to show some basic operations of the product.

1.1. Configurations

Product Name	Model/Specifications		Configuration	
FaceKiosk Series	FaceKiosk-V43 FaceKiosk-V32 FaceKiosk-H32 FaceKiosk-H21		LCD brand: New LED or LG LCD Power supply: 110–240 V AC Screen ratio: 16:9 / 9:16 Power: 70 W Standby power consumption: < 5 W Output audio: 8 ohms, 5 W Resolution: 1920 x 1080 / 1080 x 1920 Screen brightness: 300 cd/m ² Technology: Dusting or Drawing	
Main Board	CPU	Rockchip RK3399	Operating system	Android 7.1.2
	Frequency	2.0 GHZ	Built-in storage	32 GB
	Memory	4 GB DDR3	Network port	RJ45 8-core standard port; Wi-Fi port

Note: The specific configurations depend on the actual purchased product.

1.2. Installation

1.2.1 Installation Environment

Notes:

- ❖ FaceKiosk Device adopts visible light face recognition technology, so it is not recommended to place it outside, or in direct sunlight, or in window side, etc.

- ❖ FaceKiosk Device must be stationed at an indoor place with good lighting.
- ❖ The camera is especially designed for face recognition. While placing the device, please do not point the camera towards doors, windows, or other places with strong light, to avoid overexposure of the camera and affecting the face verification effect.

Operating temperature	-10°C to 50°C
Operating humidity	10% – 98%
Storage humidity	10% – 98%

1.2.2 Installation Procedure

- **Installation Procedure (Vertically):**

The upper portion of the device and the base are separately packed. The installation procedure is as follows:

Step 1: Open the packing box of the device from the side. Take out the base and put it on the top of the base box to avoid scratching. Place the packing box upside down, and take out the upper portion (put it on the side and avoid bumping).

Step 2: Remove the protective film from the base and insert the base into the card slot on the upper portion of the device.

Step 3: Open the packing box, take out the screws and wrench. Use screws to secure the base.

Step 4: Keeping the device upper part vertical, remove its protective film.

Step 5: Connect the power supply and turn on the switch at the rear of the machine.

- **Installation Procedure (Wall Hanging):**

The following tools are required for installation:

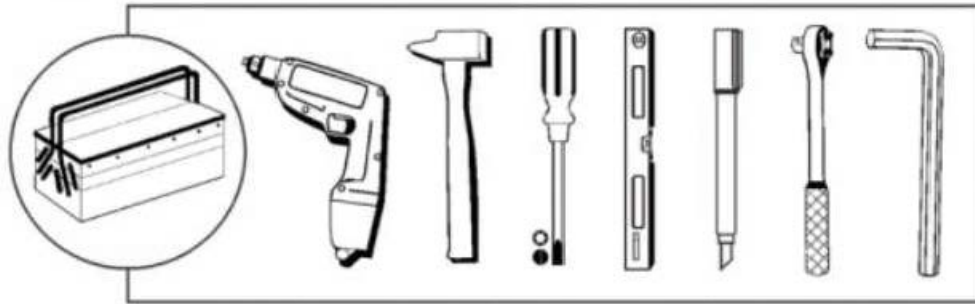

Electric drill, hammer, cross screwdriver, ruler, marker, spanner, hex wrench

Step 1: Unlock the security lock with the key, then use the cross screwdriver to turn the wall-hook screws counter-clockwise by 2-3 cm.

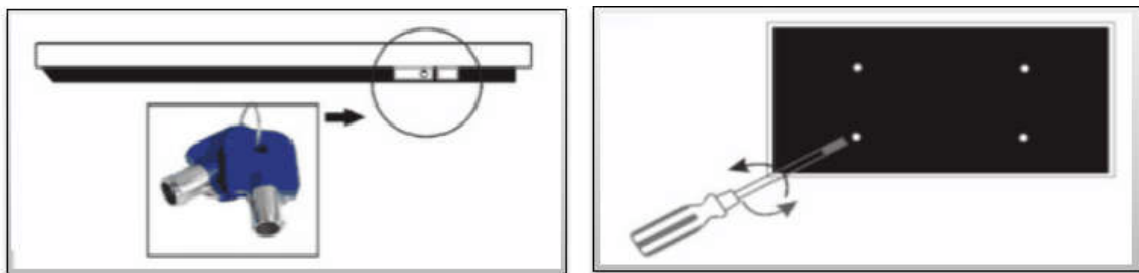

Step 2: Put a cushion on the FaceKiosk device screen to avoid scratching the glass surface. Then push the wall hanging plate towards the lock to remove the hanging plate.

Step 3: Attach the hanging plate on the wall horizontally. Mark the fixing holes with a marker where the screws need to be fixed (Generally the device below 22-inch needs 4-6 screws, device above 42-inch needs 6-8 screws)

Step 4: Drill 6-8 fixing holes with a depth of 50mm by using a 6mm or 8mm drill on the marked holes. (The number of holes depends on the weight of the device.)

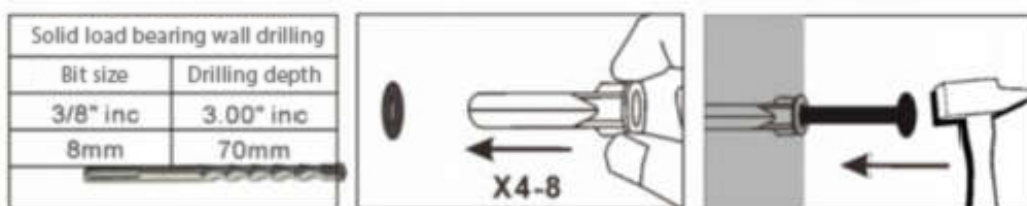

Step 5: Hammer the micelle or explosive screws of accessories into the drilled holes, then lock the hanging board with self-tapping or cap of screw tightly.

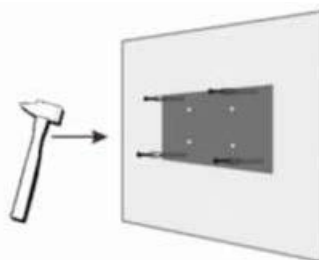

Step 6: There are four hanging holes behind the FaceKiosk device. It's easy to hang it from top to bottom aiming to

the four hanging nails on the hanging board.

Note: Due to the weight factor, the FaceKiosk device above 26-inch should be installed with the help of two people. After installation, make sure that it is fastened properly.

1.3. Precautions

1. This product can be used in an AC voltage range of 110–240 V. If the input voltage is less than 110 V or greater than 240 V, the device will not start or it may get damaged.
2. Use a socket equipped with a ground cable. Use the power cable provided in the device package to ensure proper operation of the device.
3. Keep children away from socket and follow electrical precautions.
4. Keep the device away from water, heat sources, high-voltage power transmission networks, and places with vibration or prone to shocks, to avoid short circuits and instability of the device.
5. Non-professionals should not open the rear door in power-on situation because of the high pressure inside. Shut down the device before opening the rear door.
6. Disconnect the power supply from the device if it will not be used for a longer period.
7. Avoid frequent switching on/off the device to avoid affecting the LCD service life. Start the device 3 minutes after the shutdown.
8. If any kind of liquid enters into the device, disconnect the power supply immediately and contact a professional for repair.
9. If the device emits odors, disconnect its power supply immediately and contact a professional for repair.
10. Set the display brightness and contrast lower than the maximum value, to extend the LCD service life.

Note: This product requires a 110–240 V input voltage and a total power of 70 W. This device has passed the safety inspection and had obtained 3C certification.

1.4. Notes for Access Control Wiring

1.4.1 Access Control Interface

Access Control interface is divided into 5 rows: J5, J6, J7, J8, J9. Currently J8 and J5 interface are used, rest others are reserved.

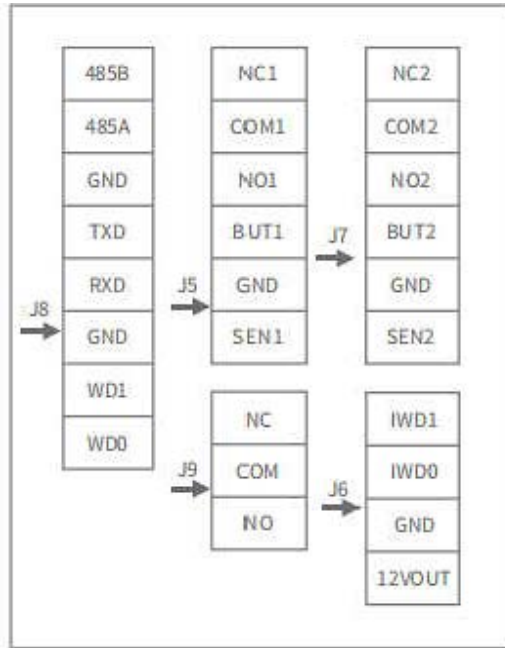

1.4.2 Connection with Lock

Connect the lock with 12V power, NC1 and COM1 into a loop, as follows:

Notes for wiring:

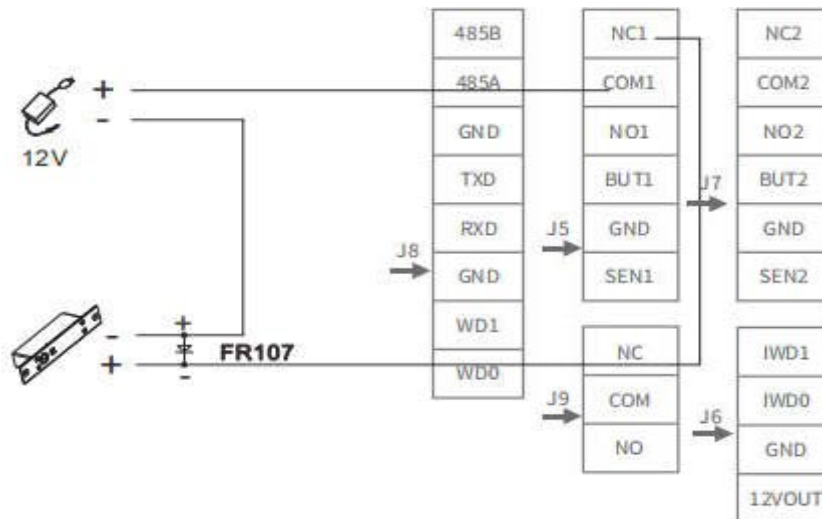

In order to avoid the influence of the self-induced electromotive force produced by the electric lock on the access control system, a diode in parallel need to be connected on the electric lock, when the access controller is connected. Select FR107 diode with a faster response speed. FR107 diode has positive (shown as "+" in the figure) and negative (shown as "-" in the figure) poles. At the time of wiring, connect the "+" of diode to the "-" of electric lock and the "-" of diode to the "+" of electric lock. Keep the diode as close as possible to the electric lock.

1.4.3 Wiegand Output Connection

When the FaceKiosk device needs to be connected to the controller through Wiegand output, connect GND, WD1 and WD0 of the controller's Wiegand input to the GND, WD1 and WD0 of J8 interface.

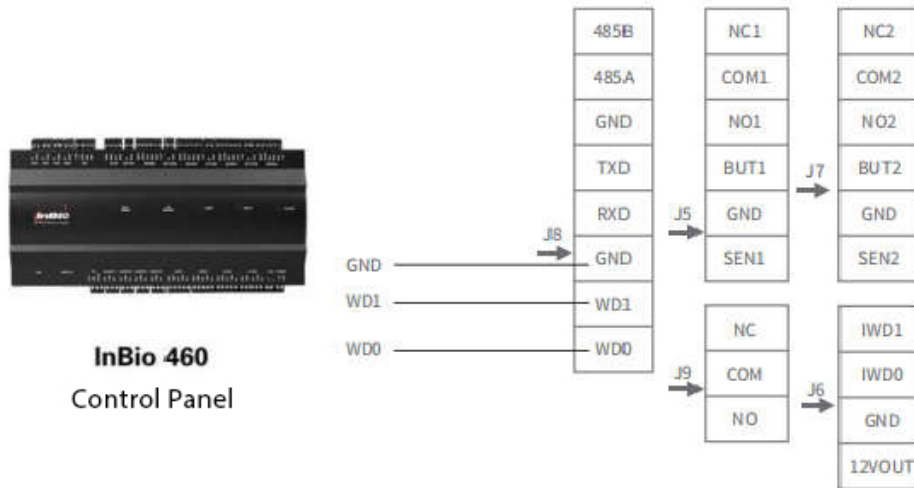

1.4.4 Recommended Identification Distance

The recommended identification distance is about 1m to 5 m from the face of the device. Recommended distance is about 3 m, shown in the following figure.

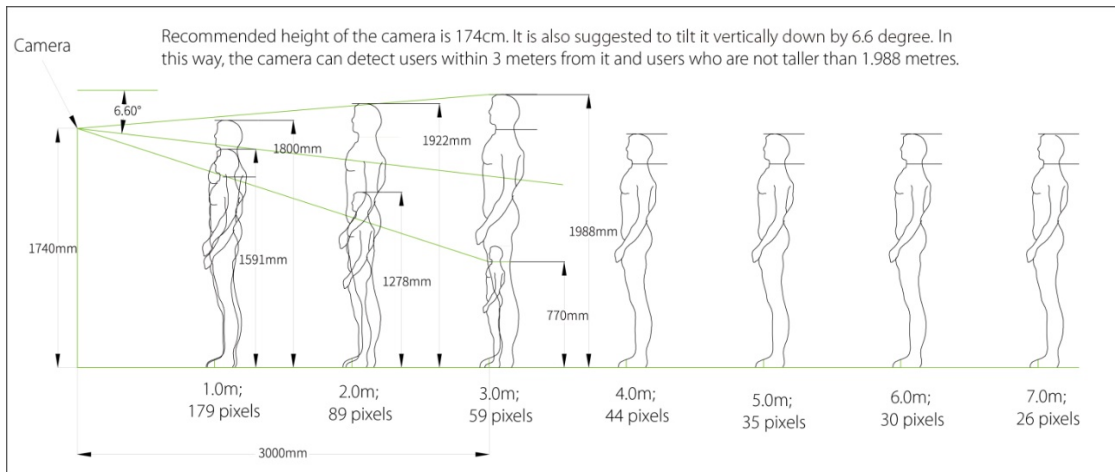

2. Check-in interface and Main Menu

1. The check-in interface is divided into 4 areas: Title bar, Information bar, Monitoring screen and Check-in result.



Title bar: It displays check-in title and main menu button.

Information bar: It displays weather, date, software connection status icon, should arrive, not arrive, actual arrive and QR code. Click should arrive, not arrive and actually arrive to view the relevant statistics.

Monitoring screen: It displays the picture captured by the camera. After detecting any face, it captures the face within the green box and pops up the verification result window after recognition.

Check-in result: It displays the relevant information about the personnel verification result.

2. On the initial screen, press  to open the main menu, as shown in the following figure.

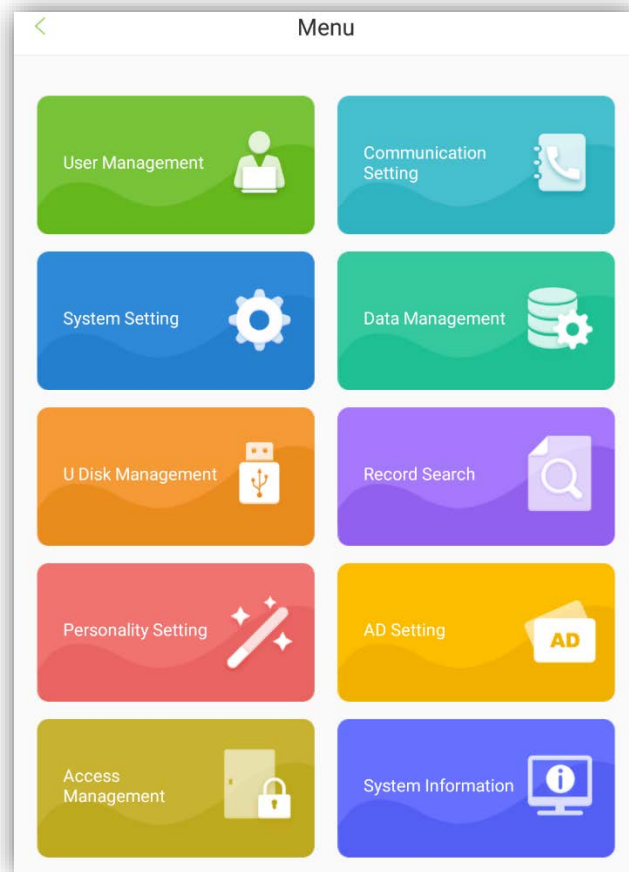

Menu	Function
[User Management]	Adds, edits, views, searches, and deletes basic employee information.
[Communication Setting]	Sets communication parameters such as the network, Wi-Fi, and PUSH.
[System Setting]	Set relevant parameters of the system, include time & date, face parameters, attendance parameters, stranger alarm function, save stranger's photo, blacklist alarm function, save blacklist photo and QR code address setting.
[Data Management]	Clears the device's record data, backup and restore data.
[U Disk Management]	Uploads or downloads data through a USB drive, and sets related parameters.
[Record Search]	Checks the attendance record, meeting information, blacklist data, stranger photo, etc.
[Personality Setting]	Sets voice broadcast, sleep time of device, display of status bar and special effects of VIP, etc.
[AD Setting]	Sets the advertisement playing, advertising frequency, etc.
[Access Control Management]	Sets the access control parameters and Wiegand function.
[System Information]	Views device information such as data capacity, device information, and firmware information.

Note: If the device has no super administrator, press  to access the menu. If the device has a super administrator, then his/her verification is required to access the menu. For security purposes, you are advised to register as an

administrator when using the device for the first time.

3. Employee Management

Click [User Mgt.] on the main menu screen. The personnel list screen is displayed, showing the basic information of all personnel, including their names, employee IDs, and portraits, as shown in the following figure.



Delete an employee: Click  in the upper right corner, select an employee, and click .

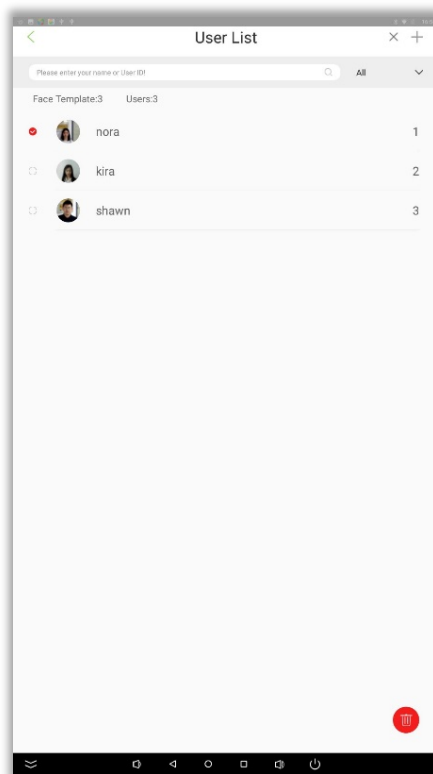

Add an employee: Click < in the upper left corner to return to the employee list screen. Click  in the upper right corner to jump to the [New User] screen, as shown in the following figure.

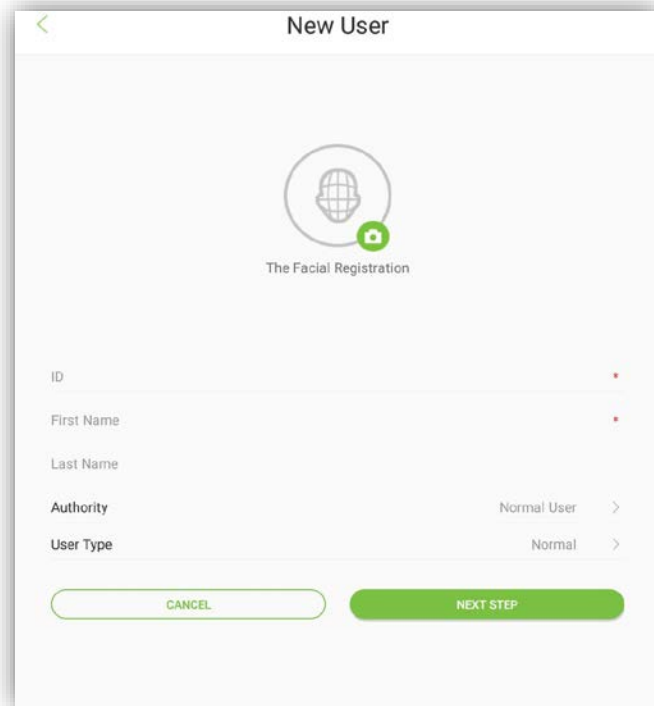

Field description:

[Authority]: It includes Normal user and Administrator. After setting an administrator, administrator verification is required to access the main menu. Administrator can set up the admin password (6 digits).

[Identity Type]: It includes Normal, VIP and Blacklist. Normal type is for normal personnel attendance. The pop-up windows effects after verification differs for VIP and Normal mode. The special effects can be set in [Personal].

If any personnel is set In blacklist, he/she cannot open the door by facial recognition. Blacklist photo capture and blacklist alarm functions can be set in [System setting].

Register a facial template: Click [Next] to call the camera. Click [START FACE ENROLLMENT] and stand in the monitoring area. When your face is identified, the registration is successful and your photo is saved.

4. Communication Settings

For the communication between device and the PC over a network, set communication parameters on the device.

Click [Wi-Fi setting] to connect to the Wi-Fi, or choose [Ethernet setting] to connect to the network by Ethernet.

4.1 Wi-Fi Settings

On the [Communication Setting] screen, click [Wi-Fi] to set WLAN parameters.

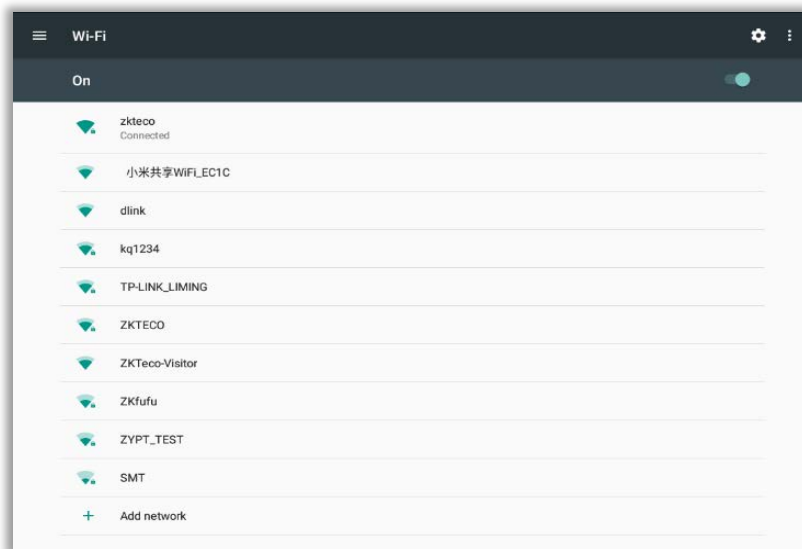

4.2 Ethernet Settings

On the [Communication Settings] screen, click [Ethernet Setting]. The [Ethernet Setting] screen is displayed.

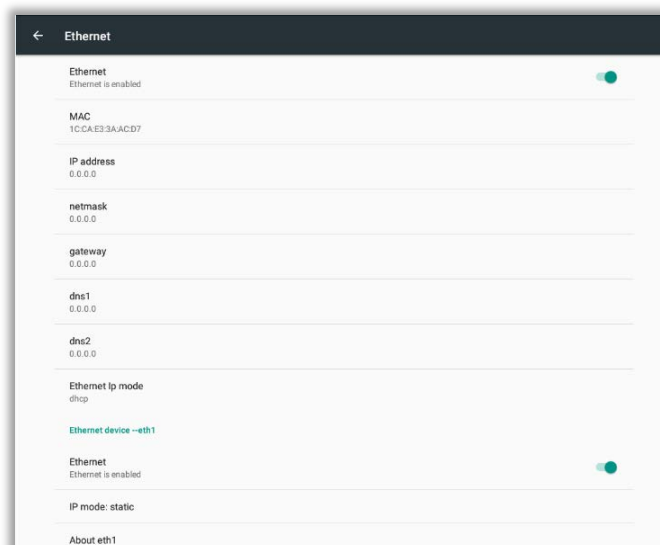

Menu	Function
[Ethernet]	Enables the Ethernet connection.
[IP address]	The default IP address is 192.168.1.201. Change it as required.
[netmask]	The default subnet mask is 255.255.255.0. Change it as required.
[gateway]	The default gateway address is 0.0.0.0. Change it as required.
[DNS]	The default address is 0.0.0.0. Change it as required.
[DHCP]	Assigns dynamic IP addresses to network clients over a server.
[IP Mode]	Only choose static mode can edit the IP.

4.3 Server Settings

Set parameters for connecting to PUSH server. On the [Communication Settings] screen, click [Cloud Server Setting].

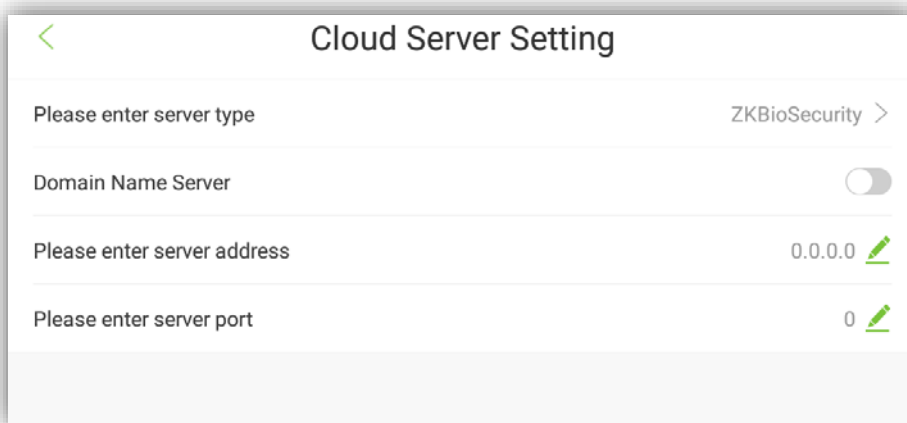

Menu	Function
Please enter server type	Choose the software you want to connect: BioTime, ZKBioSecurity.
Domain name server	Enable the domain name server.
Please enter server address	Set the server IP address of software.
Please enter server port	Set the server port of software.

5. System Settings

Set system parameters based on your requirements.

On the main menu screen, click [**System Setting**].

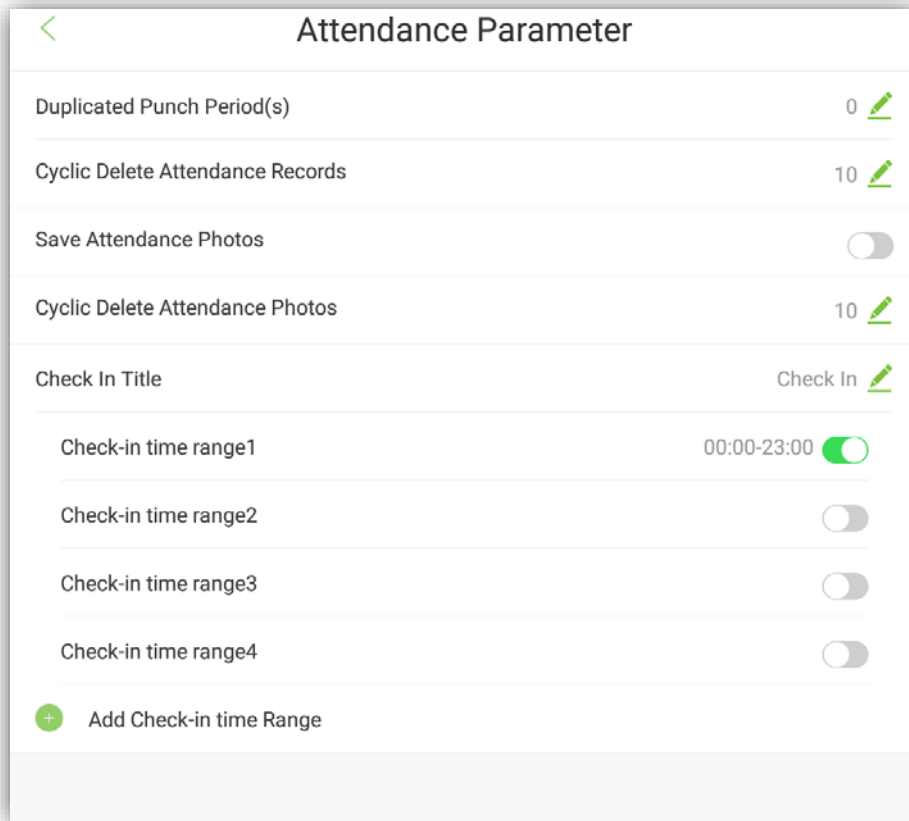

5.1 Time and Date

On the main menu screen, click [**Date & time**].

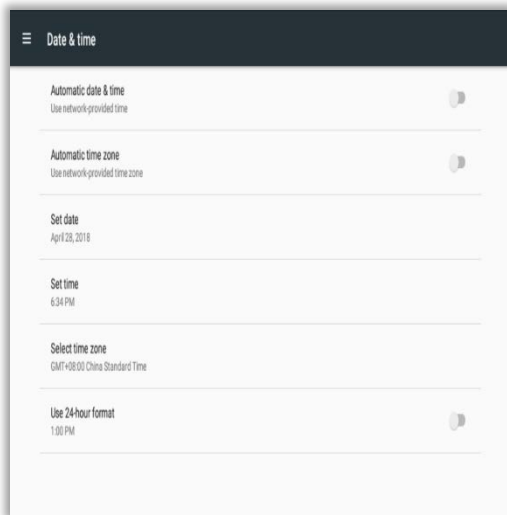

1. Click [**Date & time**].

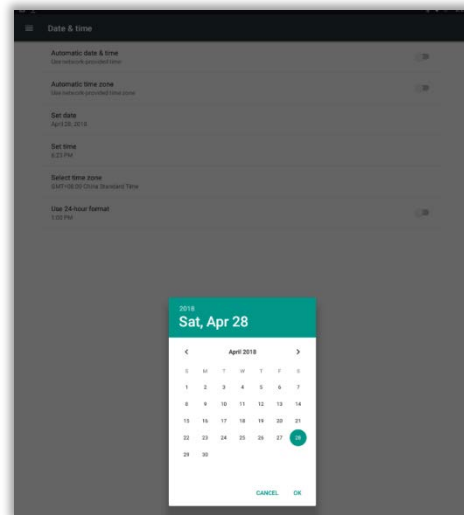

2. Scroll as required to set the year, month, and day, and press the [**OK**] key.

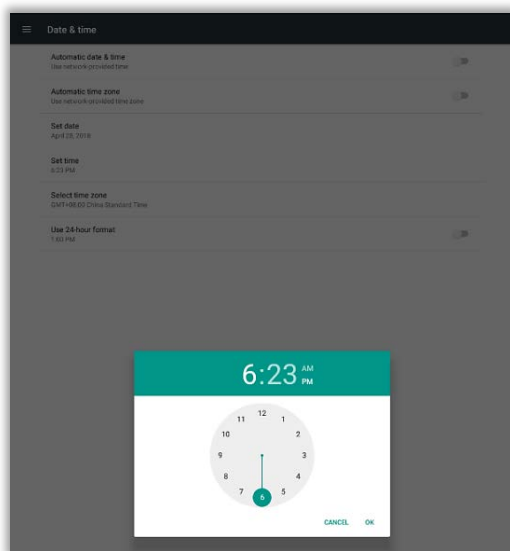

3. On the time and date screen, select [Set time].

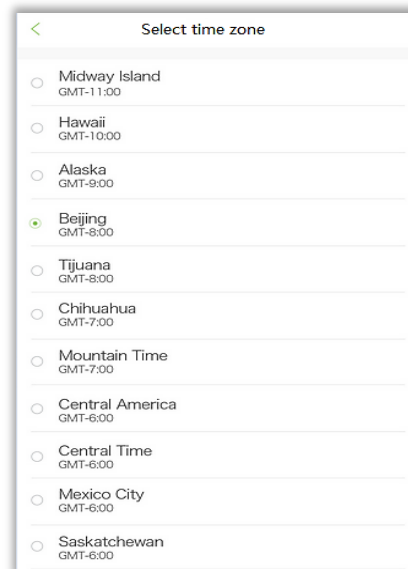

4. On the time and date screen, select [Select time zone], and scroll downwards to set the hour, minute, and second to select a time zone.

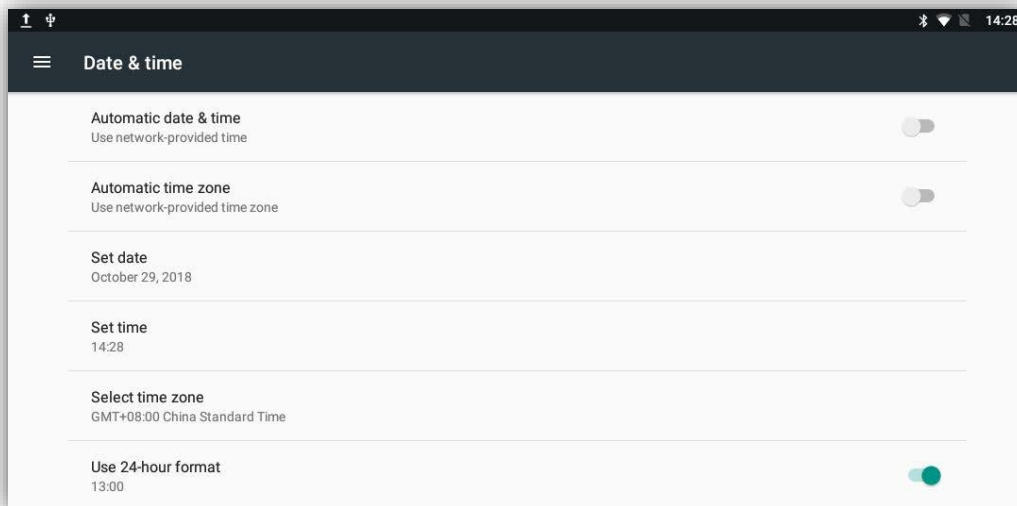

5. Click [Use 24-hour format] to display the time in the 24-hour format.

5.2 Face Parameters

Click [Face parameters] on the system setting interface to enter the following interface:

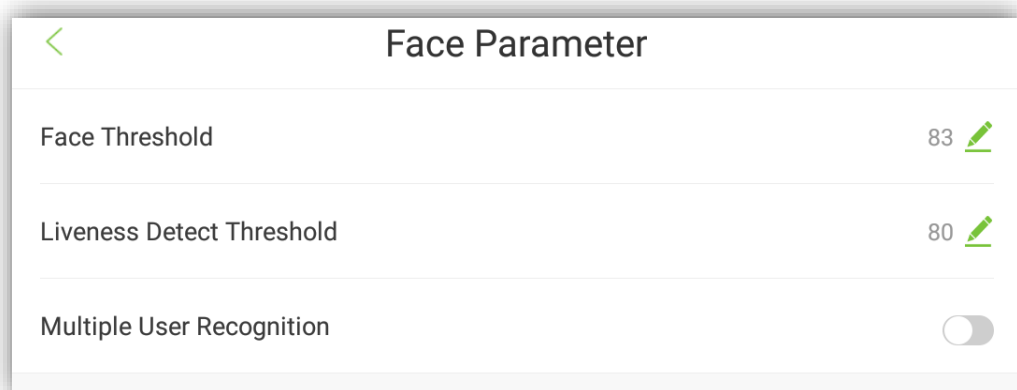

Field Description:

[Face recognition threshold]: Sets the level of similarity between the registered face templates and the verified one in device. The default value is 83, and it ranges from 83 to 95.

[Liveness detection threshold]: Lower value leads to higher accuracy with higher rejection rate. But recognition speed will be influenced. The recommended value is 80, and it ranges from 30 to 80.

[Multiple recognition]: If selected, it will support the multiple recognition function. After enabling, 4-6 persons can be recognized at the same time. It's not recommended in access control scenes.

5.3 Attendance Parameters

The relevant attendance parameters can be self-defined. The interface is as follows:

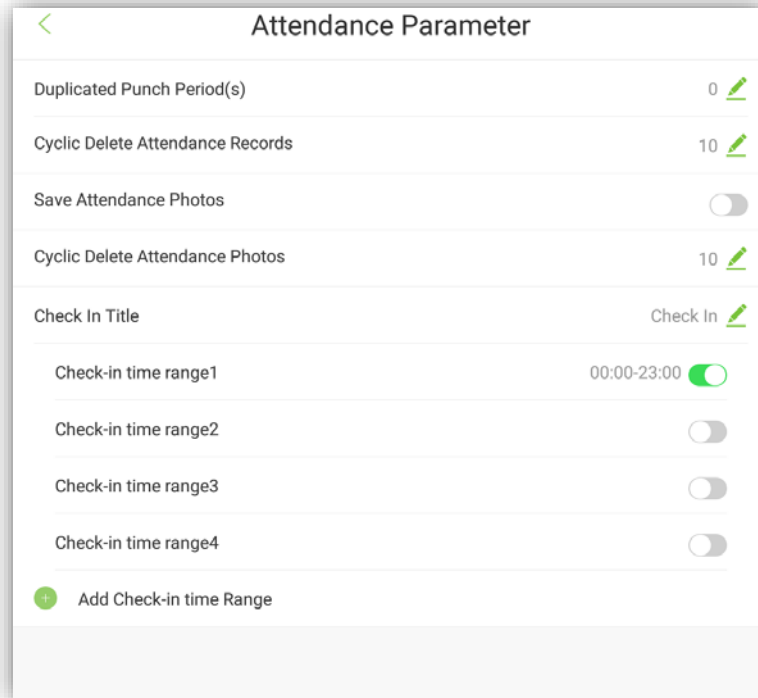

Field Description:

[Duplicate check-in period]: User can set a time-period, in which, repeated attendance record of the same employee will not be considered. (unit: second)

[Cyclic delete attendance record]: It indicates the duration up to which the attendance records will be saved. That means, when attendance record reaches the maximum capacity, it deletes the earliest record in cycle. The maximum capacity of attendance record is 10w. The range value is 0-9999. 0 means no deletion.

[Save attendance photo]: Set if you want to save the captured attendance photo after the face verification. The default is disabled.

[Cyclic delete attendance photo]: When attendance photo reaches to the maximum capacity, it will delete the earliest attendance photo in cycle. The maximum capacity of attendance photo is 1w. The range value is 0-9999. 0 means no deletion.

[Check-in title]: Set the display title of FaceKiosk device. (**Note:** When the device uses BioTime software, meeting title will automatically switch. It is sent by the software.)

[Check-in time range]: The face appearing in the monitoring area will not be identified if the device is not within

the check-in time range. It has 4 check-in time ranges by default. Now it can add more 5 time-ranges.

5.4 Stranger Photo Save Function

In the system setting interface, click [Stranger photos save function] and select to enable. When it is enabled, strangers face appearing in the monitor display interface will be recognized and captured as unregistered person. Captured photo records can be viewed in [Record Search]. When it's disabled, it will not recognize the strangers.

5.5 Stranger Alarm Function

In the system setting interface, click [stranger alarm function] and select to enable. When it is enabled, the alarm bell will sound for 10 seconds if stranger face appears in the monitoring display interface. Click on  in the main interface to turn off the alarm temporarily, as shown below:

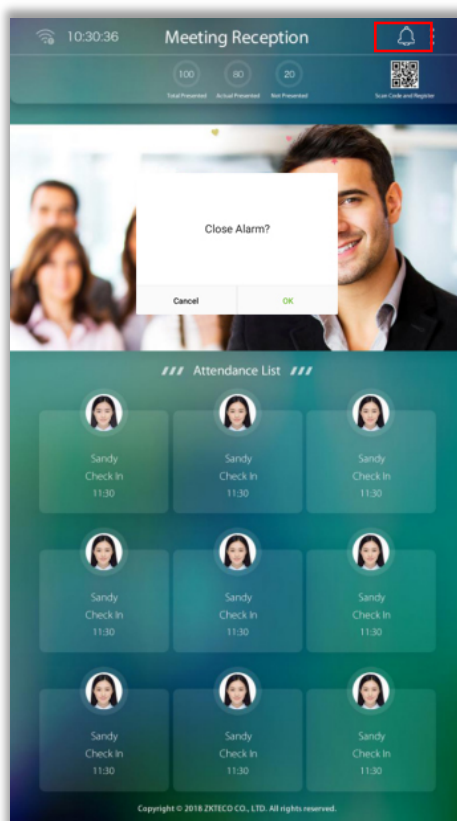

5.6 Blacklist Photo Save Function

In the system setting interface, click [Blacklist photo save function] and select to enable. When it is enabled, person

in blacklist will be captured if they appear in the monitor display interface. Captured photo records can be viewed in [Record Search].

5.7 Blacklist Alarm Function

In the system setting interface, click [Blacklist alarm function] and select to enable. When it is enabled, the alarm bell will sound for 10 seconds if person in blacklist appears in the monitoring display interface. Click on  in the main interface to turn off the alarm temporarily, as shown below:



5.8 QR Code Setting

Click [QR code address] in the system setting interface. User can set the URL address of the main interface QR code to the background server. After setting, use phone to scan the QR code in main interface. Personnel registration information interface can be displayed on the phone. If the firmware version is above 2.0, and the server address set in the device is BioTime or ZKBioSecurity software, the QR code generated in the device check-in interface will automatically obtain the device's serial number information. When user scans the QR code to register, the device's serial number will be seen in the review interface on software.

The format of QR code address is:

ZKBiosecurity3.0 software QR code address setting: http://server IP: port/app/v1/adreg

BioTime7.0 software QR code address setting: http://server IP: /facereg

6. Data Management

Click on [Data Management] in the main interface to perform delete, restore, and backup data operation.

6.1 Delete Data

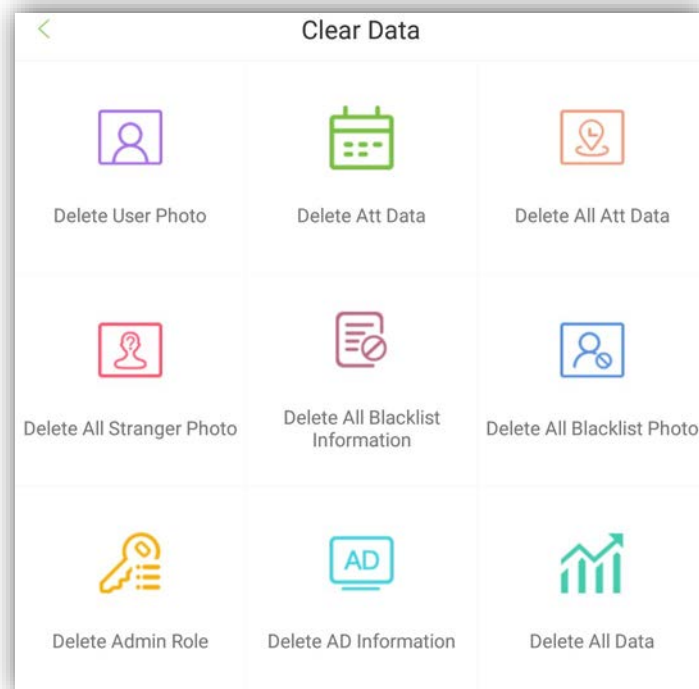

Field Instruction:

[Delete attendance record]: Deletes all attendance record in device, or for a specific period.

[Delete user photo]: Deletes all user's photo from the device.

[Delete advertisement information]: Deletes all or some specific advertisement pictures from the device.

[Delete all attendance photo]: Deletes all attendance photos from the device.

[Delete all blacklist information]: Deletes all blacklist record from the device.

[Delete blacklist photo]: Deletes all blacklist photos from the device.

[Delete stranger's photo]: Deletes all stranger's photo from device.

[Delete administrator's authority]: Deletes the authority of a specific administrator from the device.

[Delete all data]: Deletes all data from the device.

6.2 Backup Data

Click on [Backup & Restore] in the data management module. Click on [Backup data] interface, as shown below:

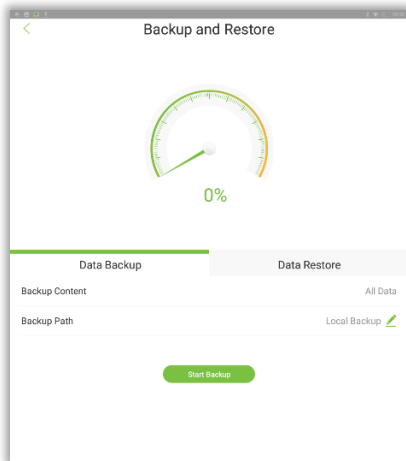

Menu	Function
Backup content	Backup all data in default, cannot be modified.
Backup path	Choose within Local backup and U-disk backup. Local backup: Backup to the specific path of the device in default. U-disk backup: Plug into the U-disk before operation.
After setting the details, click [Start backup] to backup the content to the specific path of device or U-disk.	

6.3 Restore Data

Click on [Backup & Restore] in data management module. Click on [Restore data] as shown below:

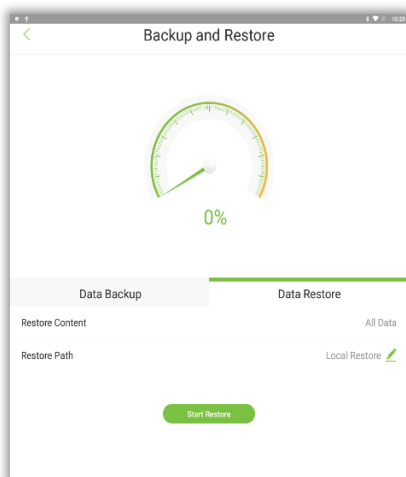

Menu	Function
Restore content	Restore all data in default, cannot be modified.
Restore path	Choose within Local restore and U-disk restore. Local restore: Restore the backup data from the specific path. U-disk restore: Plug into the U-disk before operation.
After setting the details, click [Start restore] to restore the backup data in device or U-disk.	

7. U Disk Management

On the main menu screen, click on [U Disk Management]. The [U Disk Management] screen is displayed. Insert a USB drive into the USB port on the device before uploading and downloading data over the USB drive.

7.1 Uploading Data over a USB Drive

On the [U Disk Management] screen, click on [USB Upload].

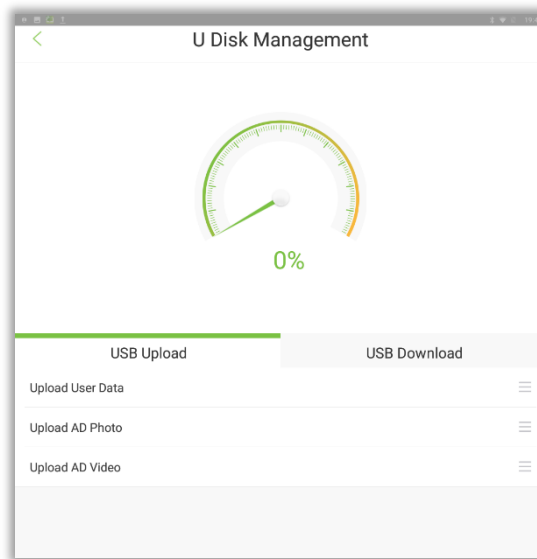

Menu	Function
[Upload User data]	Uploads user information from the USB drive to the device.
[Upload AD Photo]	<ol style="list-style-type: none">1. Storage location for advertisement-related files.2. Create a folder in the root directory of a USB drive and rename it as "ad"; then after, create a new folder "picture" in folder "ad" for saving picture advertisements. Various picture types are supported, including JPG, BMP, GIF, and PNG.
[Upload AD Video]	Create a folder "video" in folder "ad" for saving video advertisements. The supported file formats include AVI, 3GP, WMV, FLV, MP4, MKV.
Precautions	Select either advertising pictures or advertising videos on a device. For example, if advertising pictures are added to a device, advertising videos cannot be added.

7.2 Downloading Data over a USB Drive

On the USB drive management screen, click on [USB Download]. You can import data from the device to other devices over the USB drive for spare use.

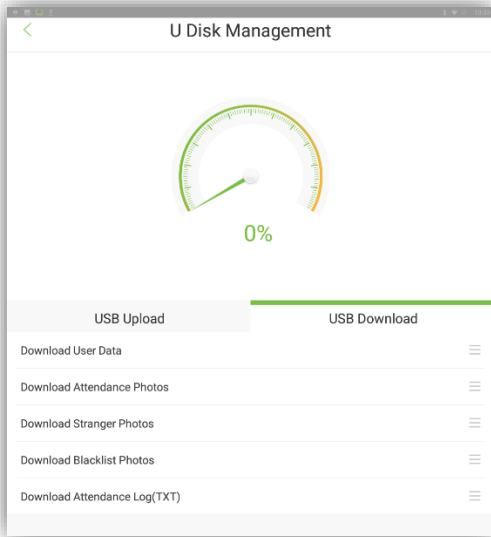

Menu	Function
[Download User Data]	Downloads user information from the device to the USB drive.
[Download attendance photo]	Download all attendance photos or for a specific time period.
[Download stranger's photo]	Download all strangers' photos in device or for a specific time period.
[Download blacklist photo]	Download all blacklist photos in device or for a specific time period.
[Download attendance record] (TXT)	Download all attendance record in device or for a specific time period. Format: TXT.

8. Record Search

Click on [Record Search] module to enter below shown interface. Related record can be checked in FaceKiosk device.

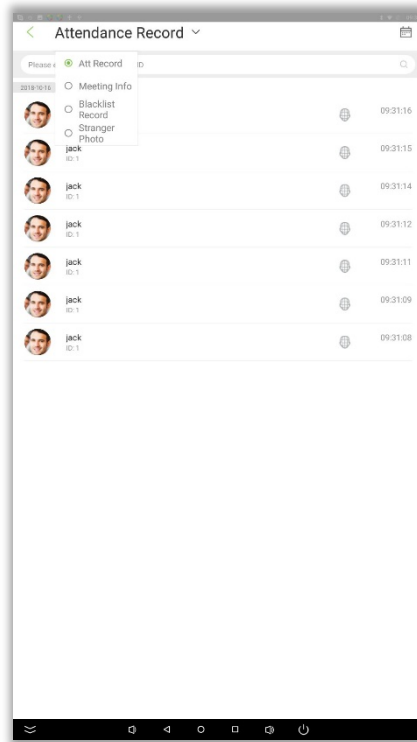

8.1 Attendance Record and Photo Search

Select [Attendance record] to view all attendance record in device. Click on  to filter the records accordingly, as shown below:

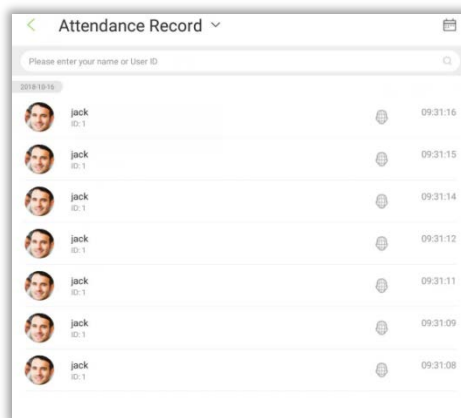

- ★ Click the head portrait of attendance record to enlarge the person photo. Display information include: Employee name, Employee ID, Check-in time, Attendance photo, as shown below:

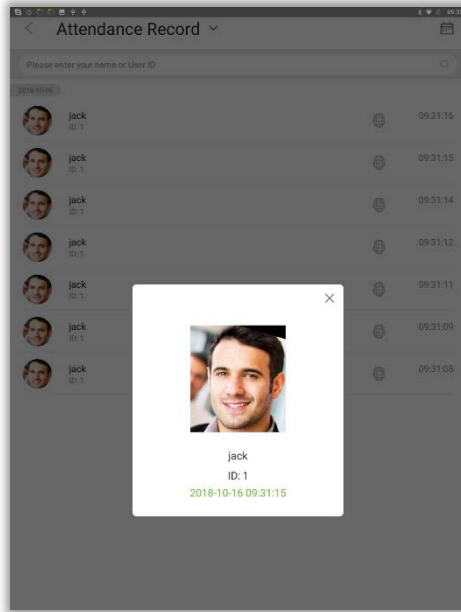

Note: If attendance photo save function is disabled, then the user's photo will be displayed.

Go to [System setting] → [Attendance parameter] to set this function.

8.2 Meeting Information

Select [Meeting record], the interface displays the list of meeting information sent by BioTime software, which includes meeting name, start and end time and number of participants. This function is only available for BioTime software, as shown below:

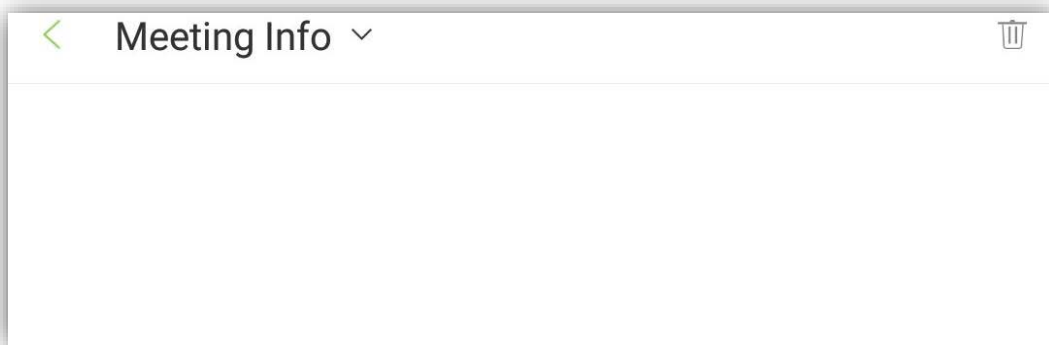

8.3 Stranger Photo

Select [Stranger photo] to view or delete the stranger's captured photo.

Go to [System setting] → [Stranger photo save function] to enable this function.

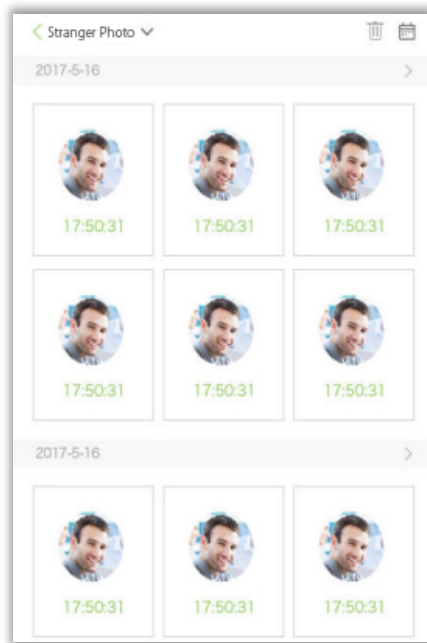

8.4 Blacklist Photo

Select [Blacklist photo] to view or delete the blacklist capture photo.

Go to [System setting] → [Blacklist photo save function] to enable this function.

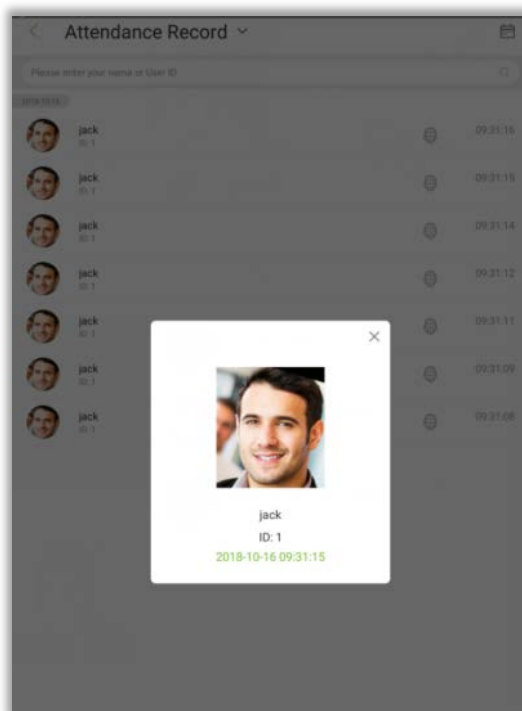

9. System Information

The **[System Info]** menu allows you to view the device storage and version information.

On the main menu screen, click on **[System Info]**.

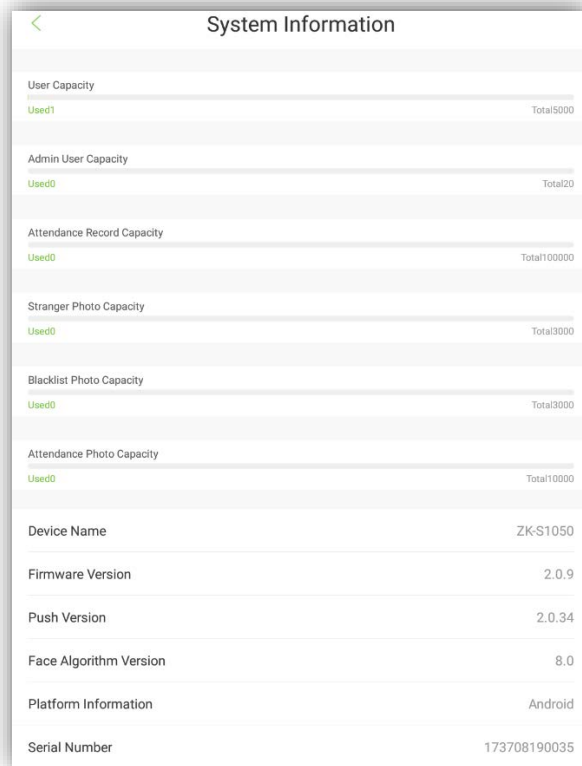

10. Advertisement Setting

On the **[AD Setting]** screen, click on **[Turn on AD Player]** to enable advertisement playing and setting the advertisement photo/video switching time, as shown in the following figure.

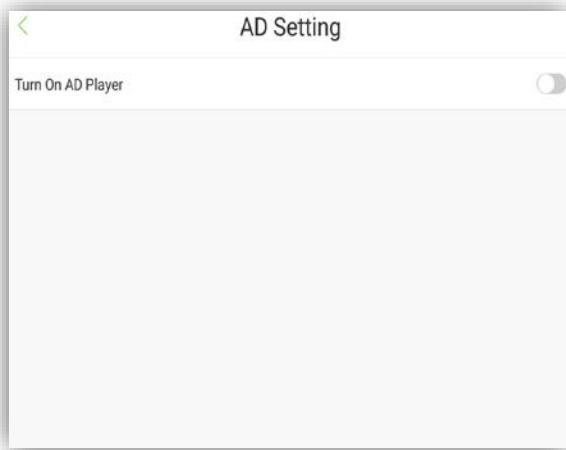

1. Enable advertisement play.

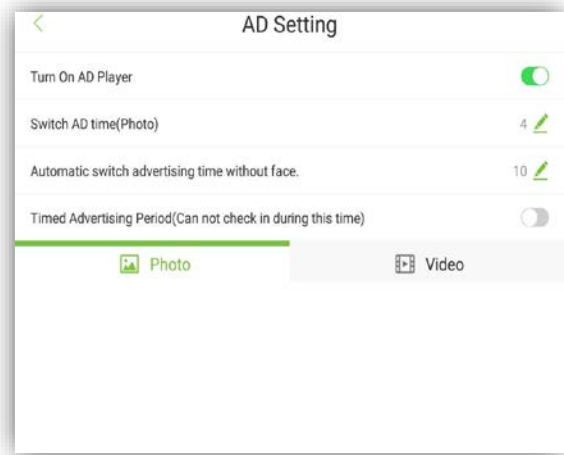

2. Select pictures/videos.

(**Note:** Select either advertising pictures or videos.)

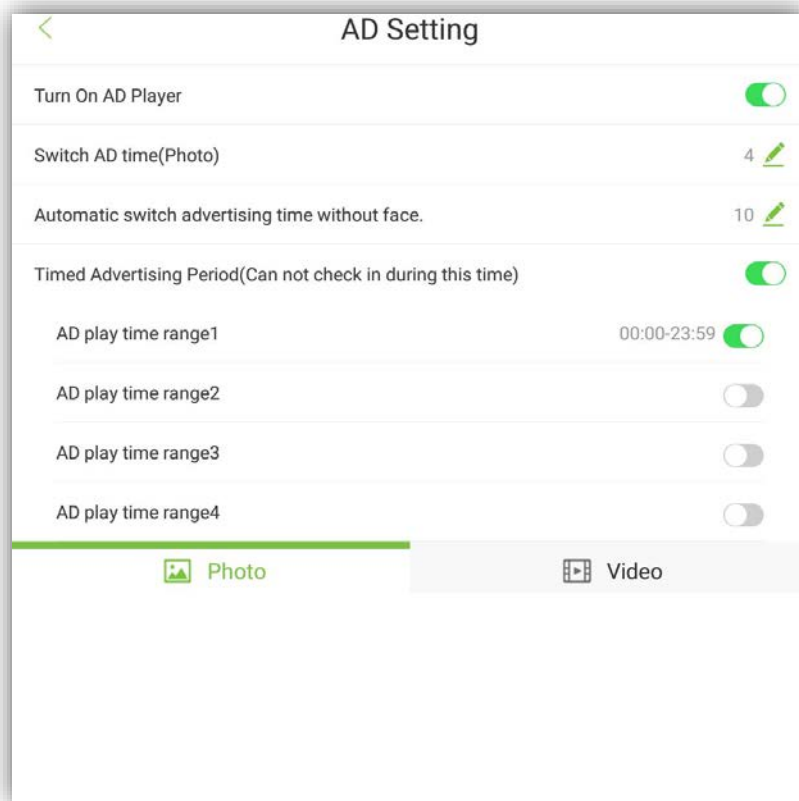

3. Set the picture or video play time (unit: s).

Field Instruction:

- Switch advertisement time: Use to set the frequency of change for advertisements.
- Automatic switch advertising time without face: Use to set the time duration after which, advertisement picture/video will be shown if no face is detected.

- Manual sliding advertisement: Slide the advertisement to the left directly from the right part of face monitoring interface to switch advertisement manually. The position is shown below:

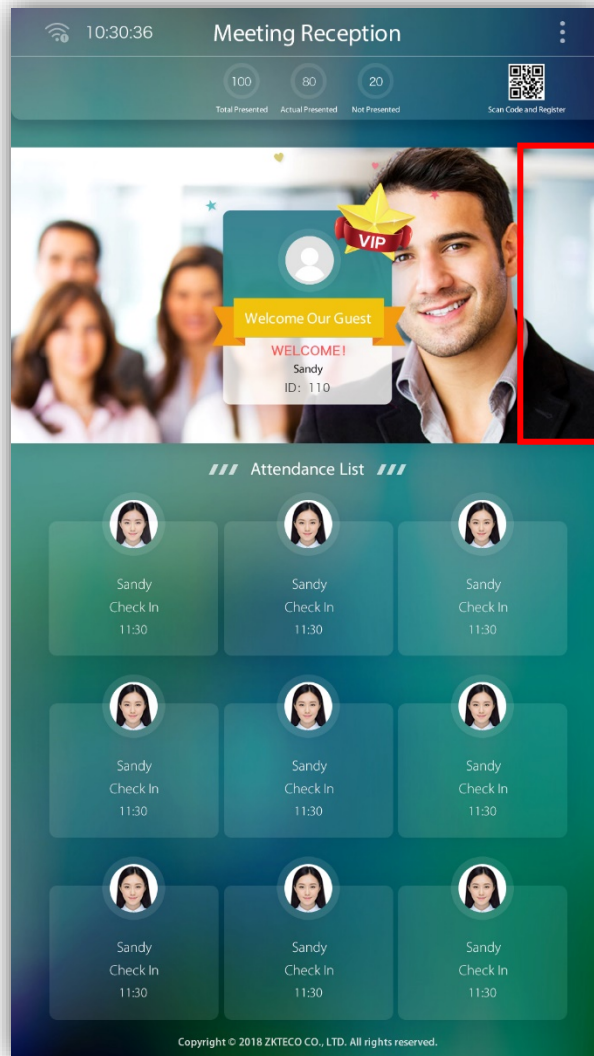

Advertisement playing time: Use to set the time period for the advertisement playing time. If the advertisement time period is repeated with the check-in time range and the check-in and check-out time of the meeting, it will switch to the face check-in interface when someone is detected in the monitoring area and then switch back to advertisement playing interface during no check-in period.

11. Personal

Click on [Personal] in the main menu. The main functions can be used to set voice broadcast content, sleep time of device, status bar display, special effects setting of VIP, etc. As shown below:



Field Instruction:

[Switch of status bar display]: Display or hide the guide bar of device.

[VIP special effects setting]: Use to set the special effects of VIP. User can choose from either of the four special effects. The default setting is no special effect.

[Switch of voice broadcast]: It will turn on the voice broadcast function.

[Voice broadcast setting]: It will set the voice broadcast content, as shown below:

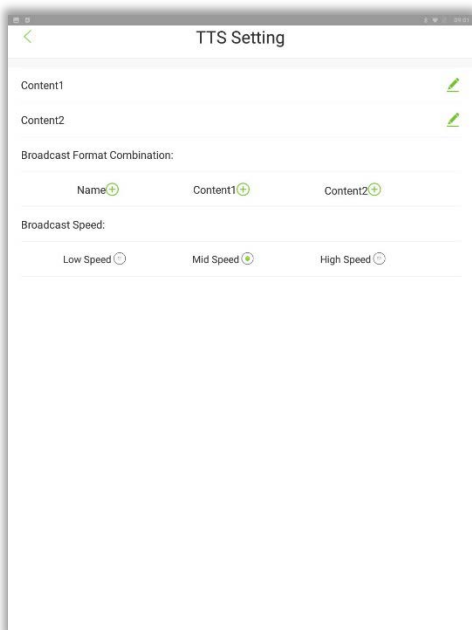

Menu	Function
Custom content 1	Support letters, numbers and Chinese character. A maximum of Five characters can be entered.
Custom content 2	Support letters, numbers and Chinese. 5 characters can be entered at most.
Broadcast format combination	Set the voice broadcast content format combination. The default is to broadcast name only.
Voice broadcast speed	Choose low speed, medium speed or high speed.

Note: Setting up more characters in this function will lead to a longer broadcast time. In multiple recognition situation, it will influence the feedback result of successful recognition. Users can choose whether to turn on this function or not according to the actual needs.

12. Access Control Management

Click on [Access control management] in the main interface of the device. Related parameters of access control can be set in this interface. As shown below:

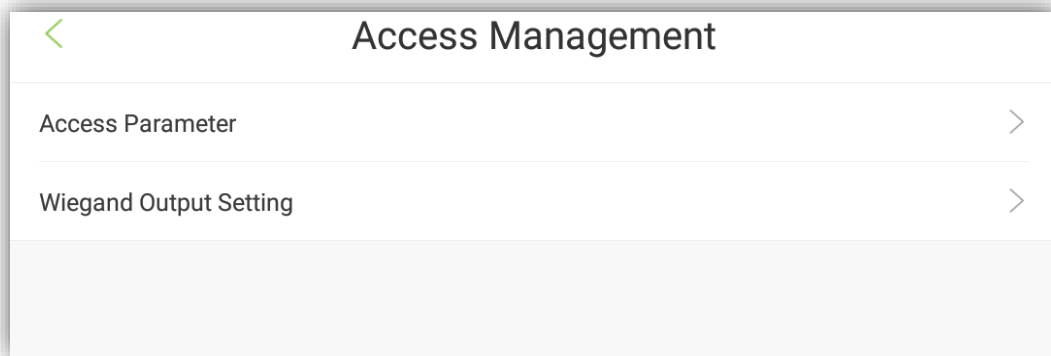

12.1 Access Control Parameters

Click [Access control parameter] to set the related parameter, as shown below:

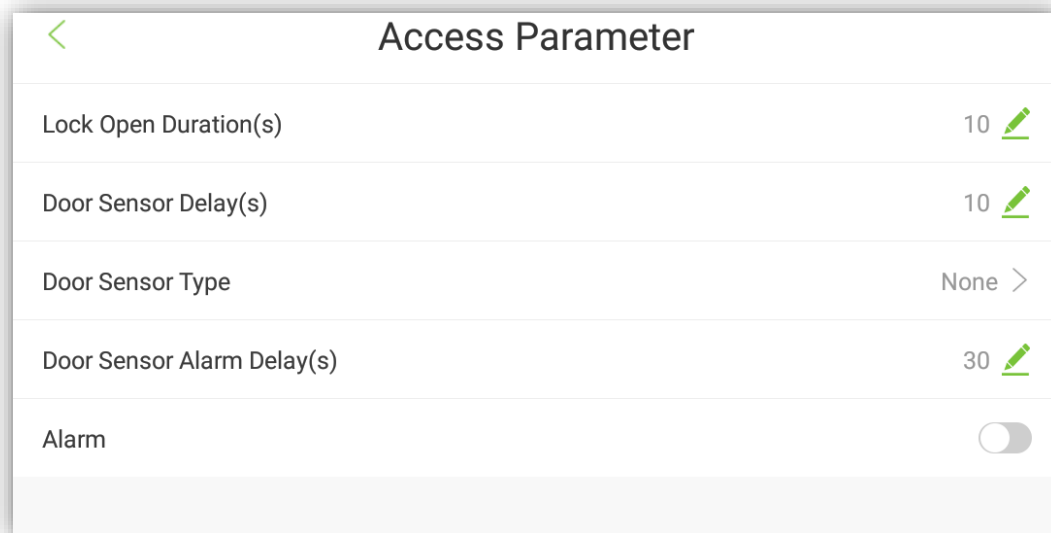

Field Instruction:

[Door Lock Delay (s)]: The time duration for which the lock will be kept unlocked by the device. (Valid value: 1~10 seconds)

[Door Sensor Delay (s)]: When the door is opened, the door sensor will be monitored after a time period; if the state of the door sensor is inconsistent with that of the door sensor mode, the alarm will be triggered. This time period is

the **Door Sensor Delay** (valid value: 1 to 99 seconds).

[Door Sensor Type]: There are three option: *No*, *Normally Open*, and *Normally Closed*.

No means door sensor is not in use;

Normally Open means the door is always opened in power-on condition;

Normally Closed means the door is always closed in power-on condition.

[Door Alarm Delay (s)]: When the state of the door sensor is inconsistent with that of the door sensor type, alarm will be triggered after a time period; this time period is the **Door Alarm Delay** (valid value: 1 to 99 seconds).

[Alarm]: Select the turn on the alarm function.

12.2 Wiegand Output Setting

Click on [Wiegand output setting] to set the related parameters, as shown below:



Field Instruction:

[Type]: Displays default User ID and it cannot be modified.

[Wiegand output bits]: The default is Wiegand34. Other options are Wiegand26, Wiegand26a, and Wiegand34a.

[Pulse Width (us)]: The default value is 100, the range is 20-400.

[Pulse Interval (us)]: The default is 1000, the range is 200-20000.

[Failed ID]: It is defined as the output value for failed user verification. The output format depends on the **[Wiegand Format]** setting. It's disabled by default; the range is 0 - 65535.

[Site Code]: Used to customize the Wiegand format. It is almost similar to device ID, the only difference is that, it can be set manually and repeated with different devices. It's disabled by default; the range is 0 - 256.

13. BioTime 7.0 Connection

By allowing the device to communicate with the attendance module of the BioTime 7.0 software, you can add users through software. In addition, you can also upload attendance records to this software for attendance calculation.

13.1 Adding a Device

There are two ways to add a device:

- Add a device automatically.

Set a server IP address and port number on the device.

- Add a device manually. The procedure is as follows:

1. On the function menu, go to [Device] → [Add]. The following screen is displayed.

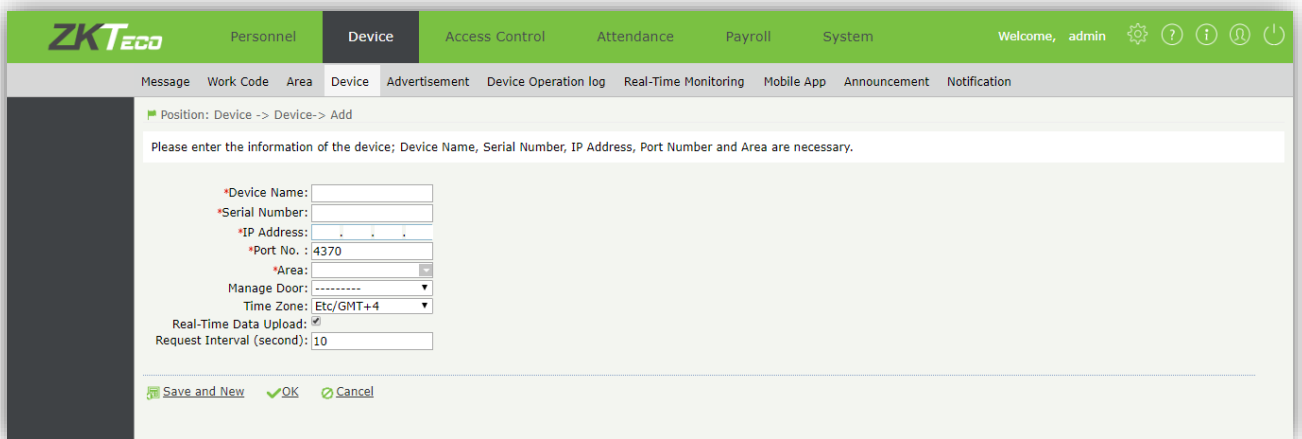

The screenshot shows the ZKTeco software interface. The top navigation bar includes 'Personnel', 'Device', 'Access Control', 'Attendance', 'Payroll', and 'System'. The 'Device' menu is selected, and the 'Add' option is chosen. The main content area displays a form titled 'Position: Device -> Device-> Add'. The form contains the following fields and options:

- *Device Name: [Text Input]
- *Serial Number: [Text Input]
- *IP Address: [Text Input]
- *Port No.: [Text Input, value: 4370]
- *Area: [Dropdown Menu]
- Manage Door: [Dropdown Menu, value: -----]
- Time Zone: [Dropdown Menu, value: Etc/GMT+4]
- Real-Time Data Upload: [Checked checkbox]
- Request Interval (second): [Text Input, value: 10]

At the bottom of the form, there are three buttons: 'Save and New', 'OK', and 'Cancel'.

2. Set parameters and click [OK] to add the device. You can click [Cancel] to cancel the addition.

The parameters are described as follows:

[Device Name]: Attendance device name. You can enter up to 20 characters.

[Serial Number]: Serial number of the attendance device.

[IP Address]: IP address of the attendance device.

[Port No]: Port number of the attendance device. The default value is 4370.

[Area]: Areas divided on the device for data management.

[Time Zone]: Attendance time divisions.

[Refresh Interval] (min): Frequency of sending a command request.

[Fixed Transmission Time]: Time of transmitting data. You can set 10 values, separated by a semicolon.

13.2 User Management

13.2.1 Adding a User

Go to [Personnel] → [Add] to add a user.

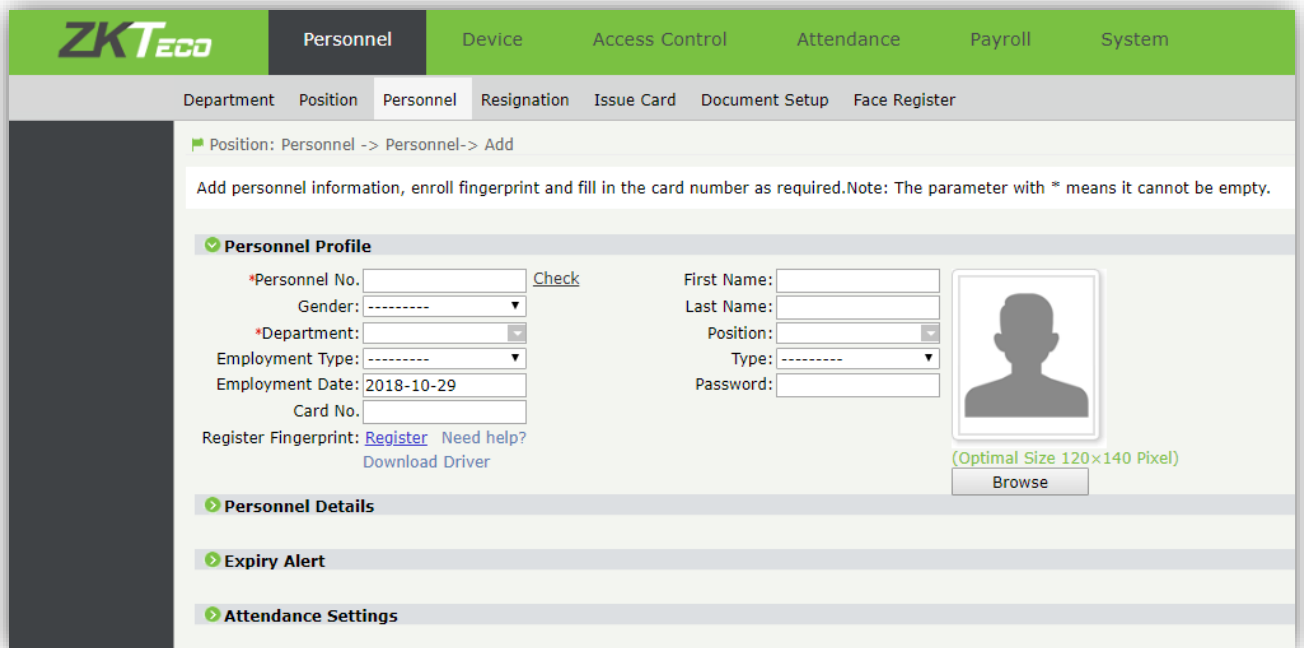

The screenshot shows the 'Personnel Add' form in the ZKTeco software. The interface has a green header with the ZKTeco logo and navigation tabs for Personnel, Device, Access Control, Attendance, Payroll, and System. Below the header, there are sub-tabs for Department, Position, Personnel, Resignation, Issue Card, Document Setup, and Face Register. The main content area is titled 'Position: Personnel -> Personnel-> Add' and includes a note: 'Add personnel information, enroll fingerprint and fill in the card number as required. Note: The parameter with * means it cannot be empty.' The form is divided into sections: 'Personnel Profile' with fields for Personnel No. (with a 'Check' link), Gender, Department, Employment Type, Employment Date (pre-filled with '2018-10-29'), and Card No.; 'Personnel Details' with fields for First Name, Last Name, Position, Type, and Password; and a section for fingerprint registration with links for 'Register', 'Need help?', and 'Download Driver'. A photo upload area is present with a 'Browse' button and a note '(Optimal Size 120x140 Pixel)'. At the bottom, there are expandable sections for 'Expiry Alert' and 'Attendance Settings'.

13.3 Attendance Management

After attendance records are uploaded to the software, set the schedule to manage attendance statistics. For details of the software, see the related user manual. Click  on the home screen to refer the help menu.

14. ZKBiosecurity Connection

By allowing device to communicate with the attendance module of the ZKBioSecurity software, you can use functions such as adding users and delivering advertising pictures or videos. In addition, you can upload attendance records to this software for attendance calculation.

14.1 Adding a Device

There are two ways to add a device:

- Add a device automatically.

Set a server IP address and port number on the device and click Enable to add the device.

- Add a device manually. The procedure is as follows:

1. On the function menu, go to [Attendance] → [Device] → [New]. The following screen is displayed.

The screenshot shows a 'New' dialog box with the following fields and options:

- Device Name* (text input)
- Device Serial Number* (text input)
- IP Address* (text input)
- Communication port* (text input, value: 4370)
- Attendance Area (dropdown menu, value: FaceOn)
- Time Zone (dropdown menu, value: Etc/GMT+8)
- Enrollment Device (checkbox, unchecked)
- Data Update Flag (checkboxes):
 - Attendance Records (checked)
 - Operation Logs (checked)
 - Attendance Photo (checked)
 - Enroll Fingerprint (checked)
 - Enroll Personnel (checked)
 - Fingerprint Picture (checkbox, unchecked)
 - Edit Personnel (checked)
 - Modify Fingerprint (checkbox, unchecked)
 - Facial Enrollment (checked)
 - Personnel Photo (checked)
- Data Sending Flag (checkboxes):
 - Send Fingerprint Data (checkbox, unchecked)
 - Send Face Data (checkbox, unchecked)
 - Send Photo (checkbox, unchecked)
- Refresh Duration(Mins) (text input, value: 1)
- Timed Sending Time (text input, value: 00:00;14:05)
- Timed Uploading Data (checkbox, checked)
- The maximum number of commands to communicate with the server. (text input, value: 20)
- Inquiry record time (text input, value: 10)

Buttons at the bottom: Save and New, OK, Cancel.

2. Set parameters and click [OK] to add the device. You can click [Cancel] to cancel the addition.

The parameters are described as follows:

[Device Name]: Attendance device name. Enter up to 20 characters.

[Device Serial Number]: Serial number of the attendance device.

[IP Address]: IP address of the attendance device.

[Communication port]: Port number of the attendance device. The default value is 4370.

[Attendance Area]: Areas divided on the device for data management.

[Time Zone]: Attendance time divisions.

[Enrollment Device]: If this option is not selected, the uploaded user data is not processed (except attendance records); if this option is selected, the uploaded user data is processed.

[Data Update Flag]: Types of data to be actively uploaded (mainly software).

[Data Sending Flag]: Data to be delivered to the device (mainly device-supported functions)

[Refresh Duration] (min): Frequency of sending a command request.

[Timed Sending Time]: Time of transmitting data. You can set 10 values, separated by a semicolon.

[The maximum number of commands to communicate with the server]: Maximum number of commands at a time.

[Inquiry record time] (s): Time interval for Searching device records.

3. Enable the device.

If you enable the device, data is uploaded and delivered properly. (Currently, the function of setting the device as a registration device is added.)

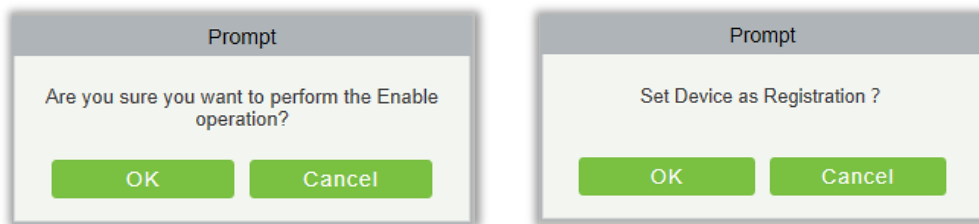

14.2 User Management

14.2.1 Adding a User

Go to [Personnel] → [Person] → [New] to add a user.

- ★ Recommended user photo requirements: Face in center, distinct face, no deformation of photo, no reflection. 640*480<pixel<1920*1080. Only jpg format is supported.

14.2.2 Uploading a Photo

To upload a photo, perform the following steps:

- (1) Go to [Personnel] > [Person] and click [Personnel ID] or [Edit]. The user profile editing screen is displayed.
- (2) Click [Browse] to select a photo and click [OK].

To capture a photo, perform the following steps:

- (1) Connect to an external camera, or switch to the built-in camera of the device.
- (2) Go to [Personnel] > [Person] and click [Personnel ID] or [Edit]. The user profile editing screen is displayed.
- (3) Click [Capture]. The photo capturing screen is displayed. The browser allows you to select the camera. The screen is as follows:

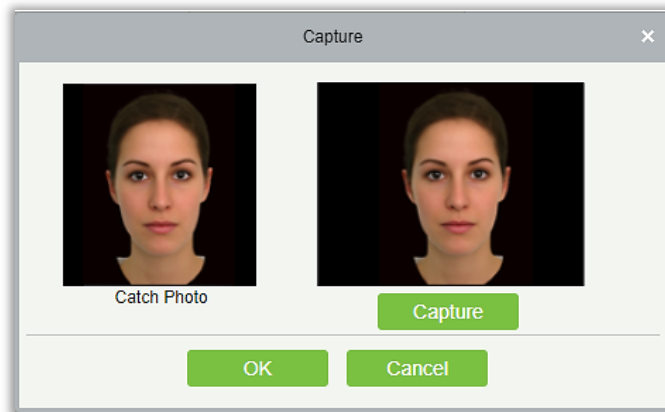

(4) Click on [Capture] to capture the photo and click [OK].

14.2.3 Importing User Information in Batches

1. Export the user information template, click [Export], select [Export Personnel], select user information fields, and click [OK] to download the template.

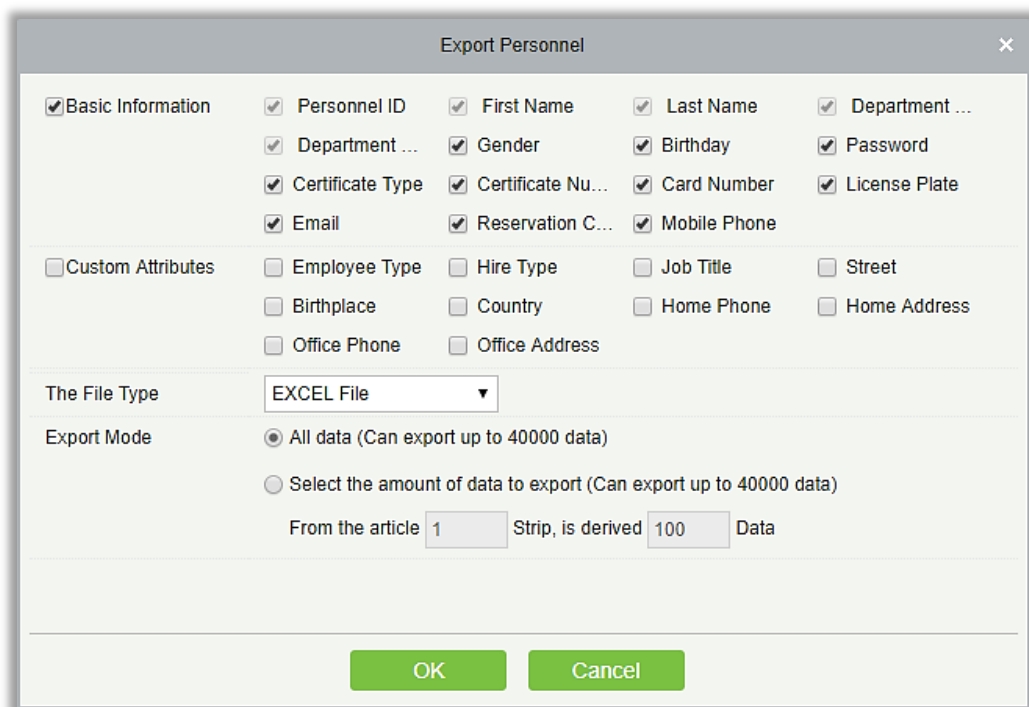

2. Fill in the template information.
3. Click on [Import] and select [Import Personnel]. The import screen is displayed.

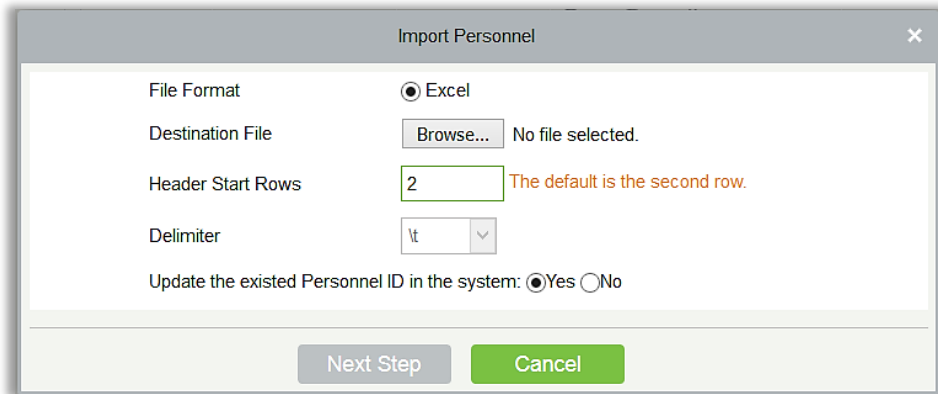

The parameters are described as follows:

[File Format]: The imported file format is Excel.

[Destination File]: Click [Browse] to select a file to be imported.

[Header Start Rows]: Enter the first line of the data.

[Update the existed Personnel ID in the system]: If you select [Yes], the user information is updated; if you select [No], the user information remains unchanged.

14.2.4 Importing User Photos in Batches

- ★ Recommended user photo requirements: Face in center, distinct face, no deformation of photo, no reflection. 640*480<pixel<1920*1080. Only jpg format is supported.

Click [Import] and select [Import User Photos] to enter the [Import Photos] interface.

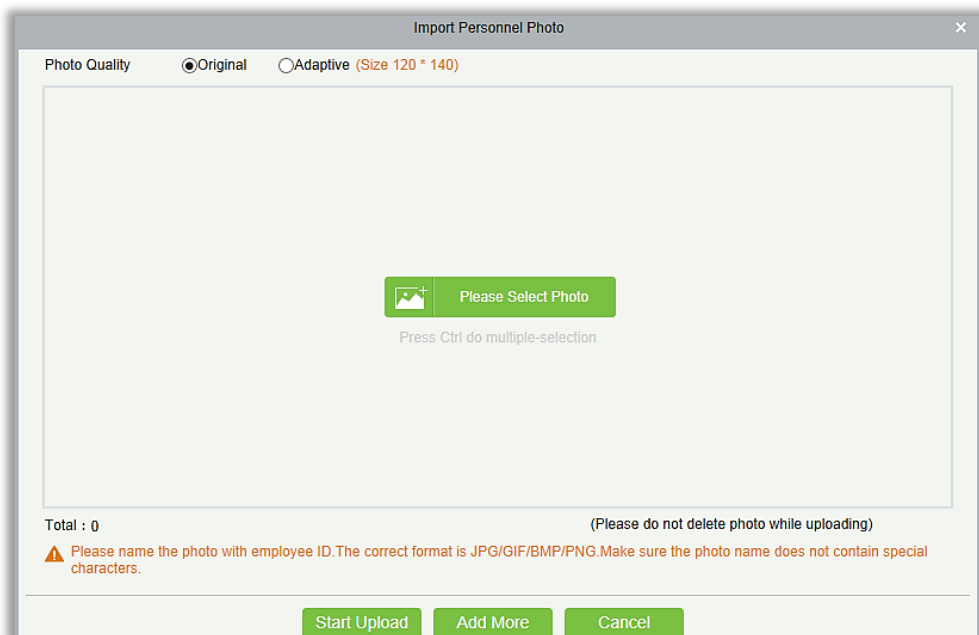

Note: Use the employee ID to name the photo. The supported format is JPG. The photo name must not contain special characters.

Click on [Please Select Photo] and select multiple photos by pressing Ctrl. Click on [Start Upload] to import the photos.

14.3 Adding Advertisement

Note: You can either add pictures or videos as an advertising. That means, if any picture is already added as an advertising picture to the device, then a video cannot be added.

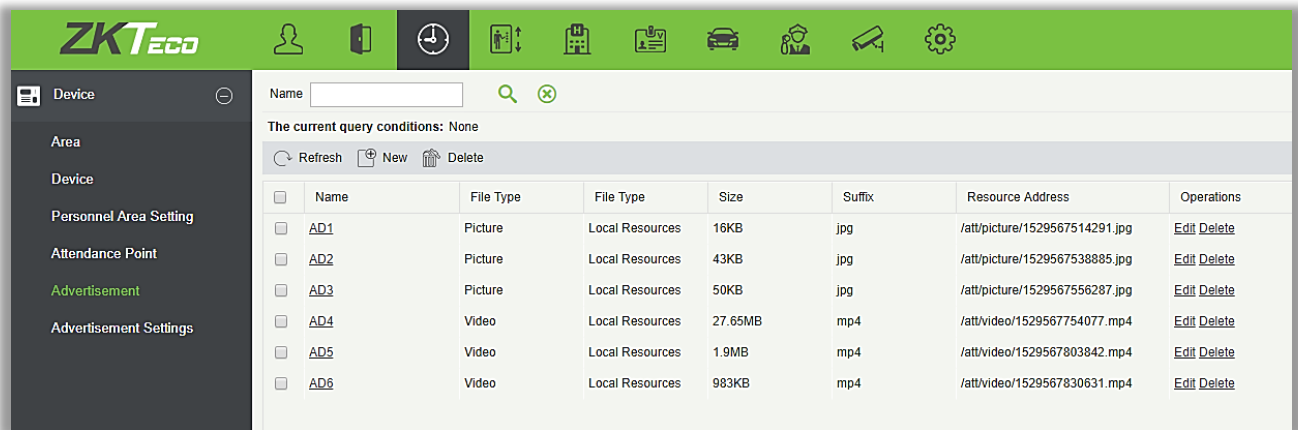

The screenshot shows the ZKTeco management interface. The top navigation bar is green with the ZKTeco logo and various icons. The left sidebar is dark grey with a menu including 'Device', 'Area', 'Device', 'Personnel Area Setting', 'Attendance Point', 'Advertisement' (highlighted in green), and 'Advertisement Settings'. The main content area displays a table of advertisements. Above the table, there is a search bar, a 'Name' field, and a search icon. Below the search bar, it says 'The current query conditions: None'. There are buttons for 'Refresh', 'New', and 'Delete'. The table has columns for Name, File Type, File Type, Size, Suffix, Resource Address, and Operations. The data rows are as follows:

<input type="checkbox"/>	Name	File Type	File Type	Size	Suffix	Resource Address	Operations
<input type="checkbox"/>	AD1	Picture	Local Resources	16KB	jpg	/att/picture/1529567514291.jpg	Edit Delete
<input type="checkbox"/>	AD2	Picture	Local Resources	43KB	jpg	/att/picture/1529567538885.jpg	Edit Delete
<input type="checkbox"/>	AD3	Picture	Local Resources	50KB	jpg	/att/picture/1529567556287.jpg	Edit Delete
<input type="checkbox"/>	AD4	Video	Local Resources	27.65MB	mp4	/att/video/1529567754077.mp4	Edit Delete
<input type="checkbox"/>	AD5	Video	Local Resources	1.9MB	mp4	/att/video/1529567803842.mp4	Edit Delete
<input type="checkbox"/>	AD6	Video	Local Resources	983KB	mp4	/att/video/1529567830631.mp4	Edit Delete

14.3.1 Add Advertising Pictures

Click on [Attendance] → [Device] → [Advertisement], the interface is shown below:

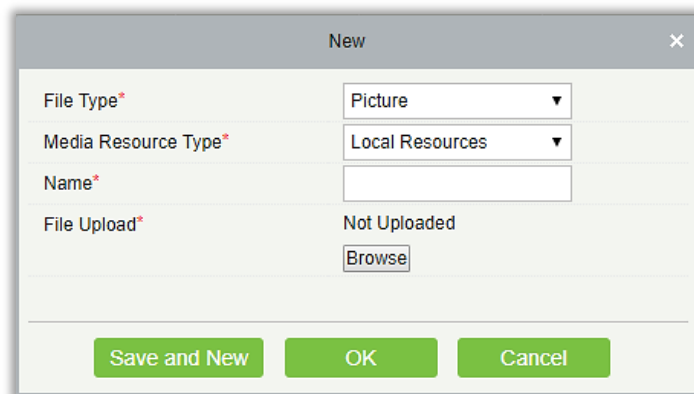

The 'New' dialog box is shown with the following fields and options:

- File Type***: Picture (dropdown menu)
- Media Resource Type***: Local Resources (dropdown menu)
- Name***: (empty text input field)
- File Upload***: Not Uploaded (radio button selected), with a **Browse** button below it.

At the bottom of the dialog box, there are three buttons: **Save and New**, **OK**, and **Cancel**.

[File Upload]: Click [Browse] and select the desired image file to upload. The size and suffix name will be displayed automatically.

[Name]: Enter the image name of the advertisement. It shouldn't be more than 10 characters.

[Delete the Pictures]: Go back to the list of advertising images, select the images to be deleted, and click [Delete].

14.3.2 Add AD Video

Click [Attendance] → [Device] → [Advertisement], the interface is shown below:

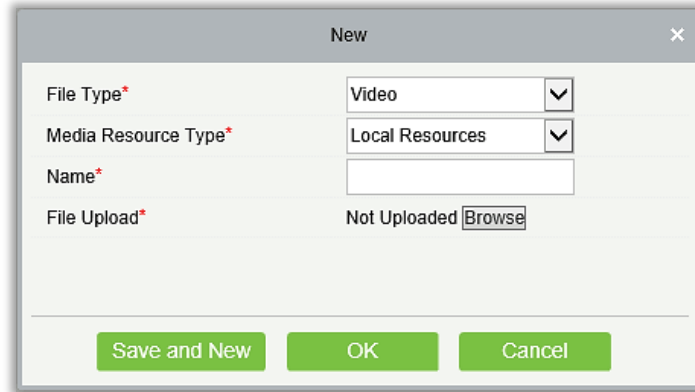

The 'New' dialog box contains the following fields and controls:

- File Type***: Video (dropdown menu)
- Media Resource Type***: Local Resources (dropdown menu)
- Name***: (empty text input field)
- File Upload***: Not Uploaded (text) and Browse (button)

At the bottom of the dialog are three buttons: Save and New, OK, and Cancel.

[File Upload]: Click [Browse] to select the required video to be uploaded. Size, suffix name will be displayed automatically.

[Name]: Enter the desired video name, it shouldn't be more than 10 characters.

[Delete the Video]: After creation, go back to the list of advertising video, then select the video that needs to be deleted, and click [Delete].

Note: if the advertisement video is too big (over 50MB), then it needs to be uploaded by USB disk. The video issued by the software only supports MP4, WMV and AVI format, and the size is within 50 MB. Image supports JPG, BMP, GIF and PNG format.

14.3.3 Advertisement Settings

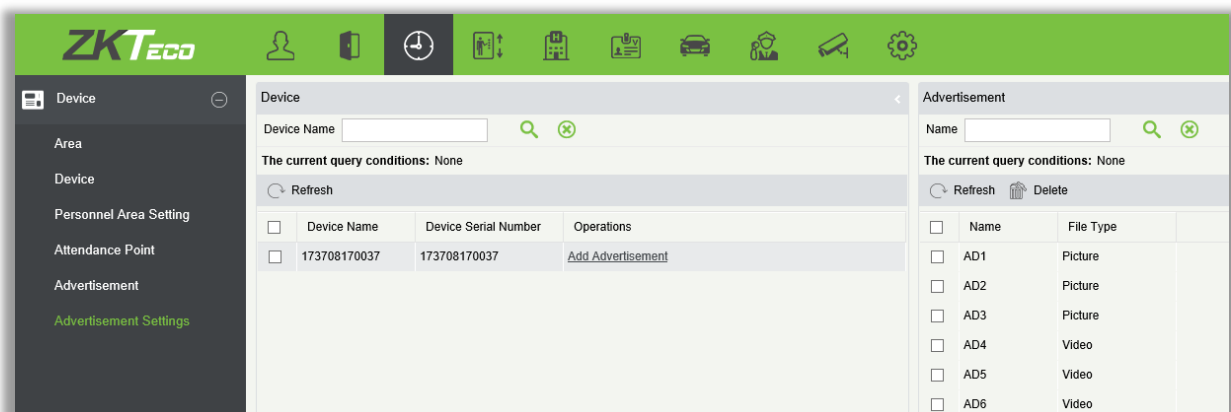

The screenshot shows the ZKTeco software interface with the 'Advertisement Settings' page selected in the left sidebar. The main content area is divided into two panels: 'Device' and 'Advertisement'.

Device Panel:

- Search field: Device Name
- Current query conditions: None
- Refresh button
- Table with columns: Device Name, Device Serial Number, Operations
- Table content:

Device Name	Device Serial Number	Operations
173708170037	173708170037	Add Advertisement

Advertisement Panel:

- Search field: Name
- Current query conditions: None
- Refresh and Delete buttons
- Table with columns: Name, File Type
- Table content:

Name	File Type
AD1	Picture
AD2	Picture
AD3	Picture
AD4	Video
AD5	Video
AD6	Video

- Add Advertisement

Click on the [Add Advertisement] button under the device to set the advertisement content of the device. The content list is added from the [Advertisement] column.

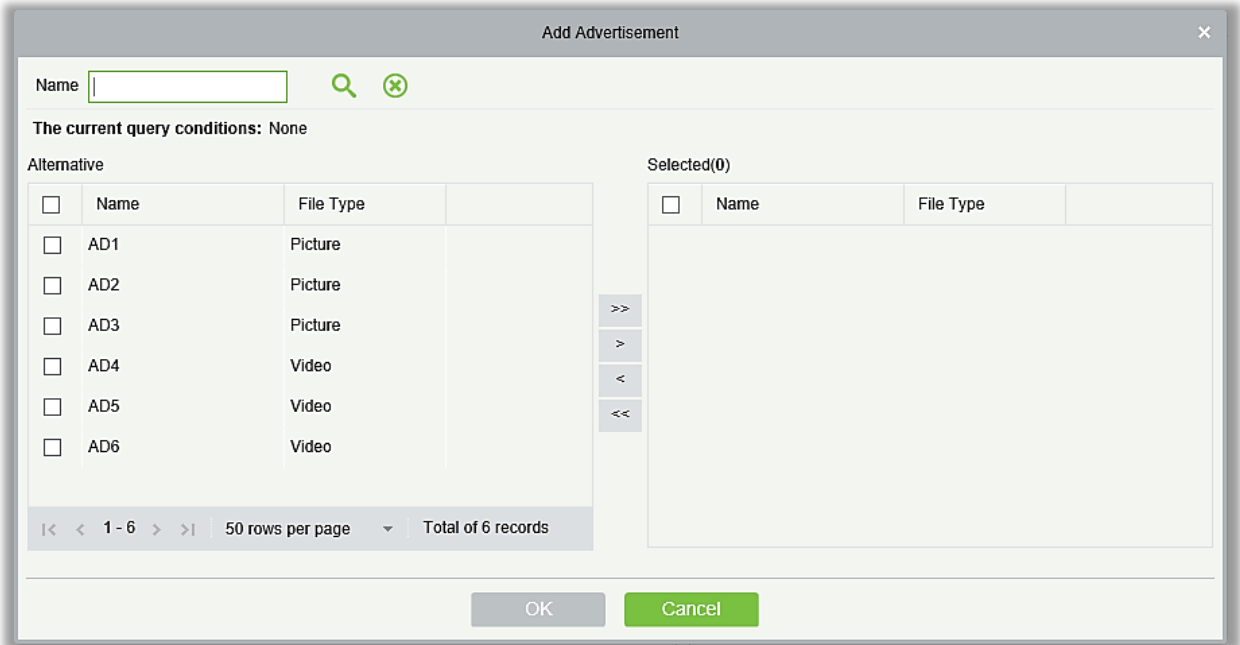

- Delete advertisement

Select the required advertisement and click [Delete] to remove the advertisement content.

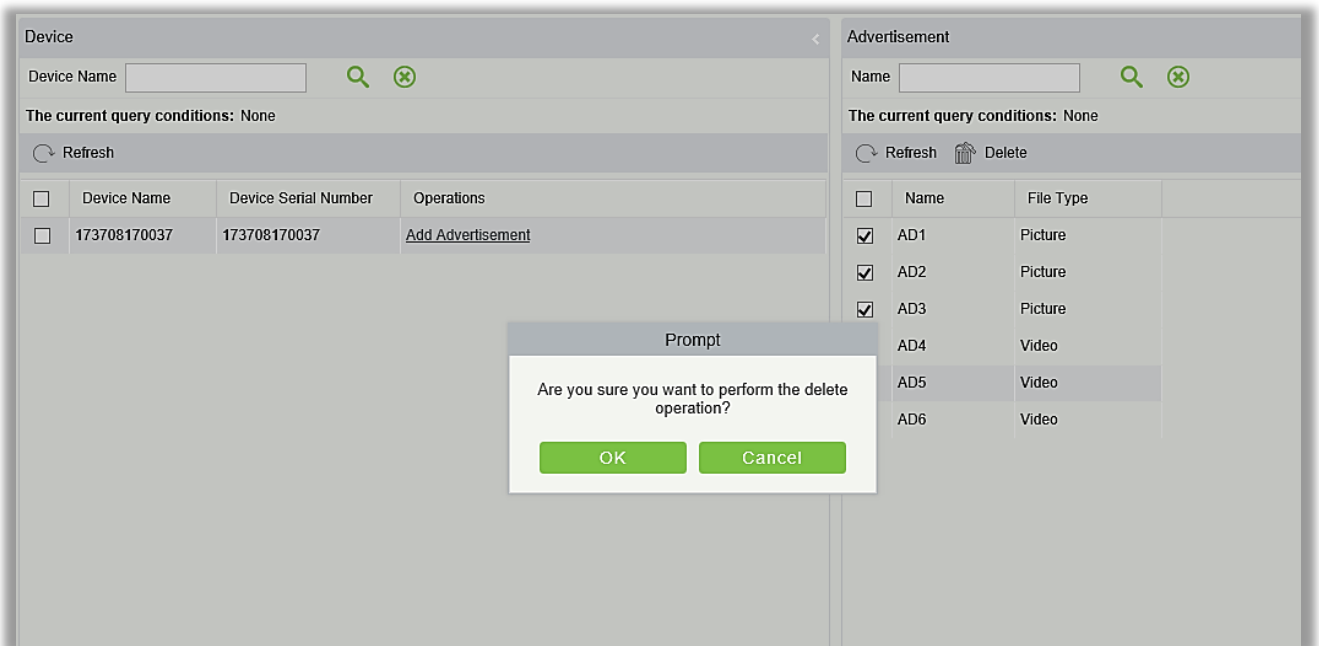

14.4 Attendance Management

After attendance records are uploaded to the background software, set the schedule to manage attendance statistics.

For details of the background software, see the related user manual. Click  on the home screen to obtain the help system.

14.5 Scan Code Registration

1. Go to the main interface of the information screen device, then open [Scan] function in mobile phone and scan the QR code, the registration interface will be displayed, enter the name and work number information, and click upload avatar or take photo. Allow [Access to Mobile Phone Camera] to open the mobile phone camera and capture photo. After capturing a photo, click registration to open the registration. (**Note:** Background setting is required for the default opening of the scanning registration function for the verification. You can choose to close it.)
2. After background verification: The software background interface is shown. Click [Personnel]→[Personnel]→[Temporary Personnel]

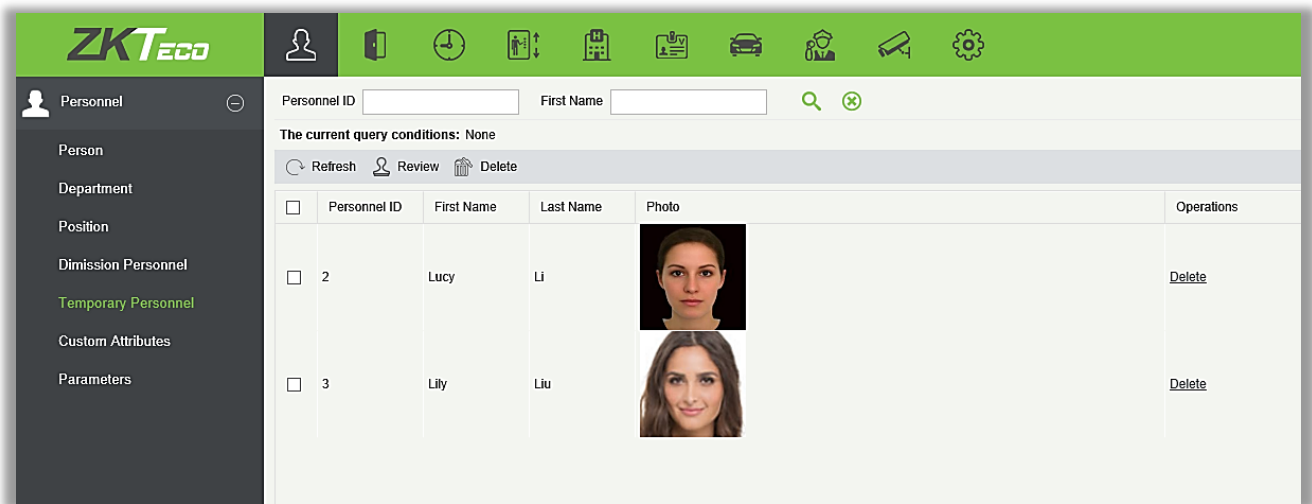

Select the desired personnel and the administrator. Click [Audit] to check and verify. Only after the successful approval, face verification can be carried out through the device.

ZK Building, Wuhe Road, Gangtou, Bantian, Buji Town,
Longgang District, Shenzhen China 518129

Tel: +86 755-89602345

Fax: +86 755-89602394

www.zkteco.com

