

Quick Start Guide

ProFace X [P]

Version: 1.0

Date: April 2020

1 Overview

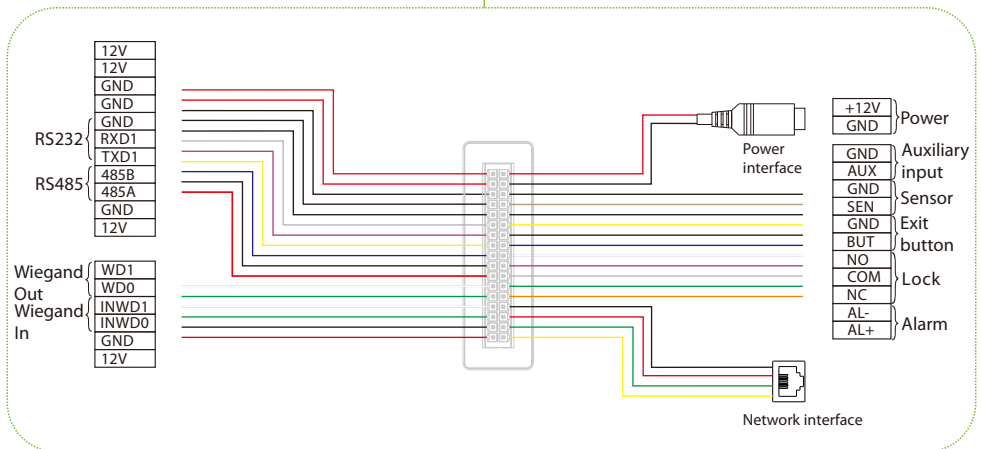
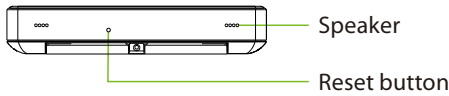
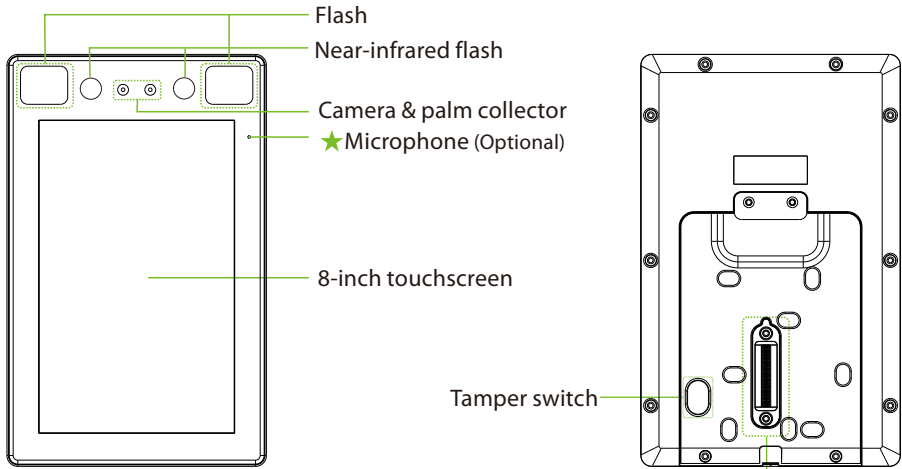

2 Installation Environment

Please refer to the following recommendations for installation.



INDOOR USE



KEEP DISTANCE



AVOID GLASS
REFRACTION



AVOID DIRECT
SUNLIGHT
AND EXPOSURE

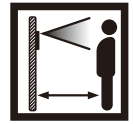

KEEP EFFECTIVE
DISTANCE
0.3-2.5m

3 Device Installation

❖ Install on the wall

- ① Attach the mounting template sticker to the wall, and drill holes according to the mounting paper.
- ② Fix the back plate on the wall using wall mounting screws.
- ③ Attach the device to the back plate.
- ④ Fasten the device to the back plate with a security screw.

①

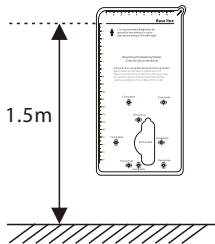

②

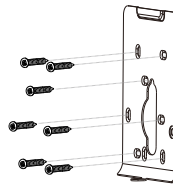

③

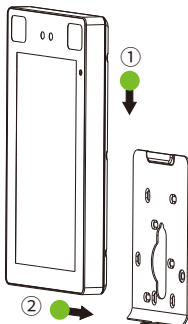

④

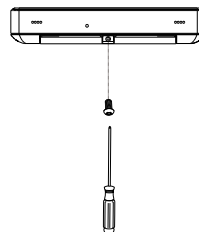

3 Device Installation

❖ Install on the barrier gate

Please thread the wire through the bracket before installation.

- ① Drill a hole on the barrier gate, insert the bracket into the hole and fix it with a nut.
- ② Adjust the angle of the device.

①

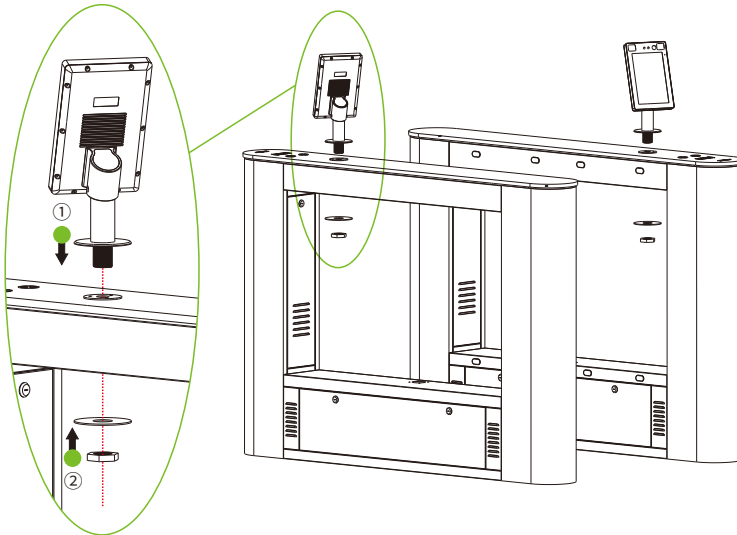

②

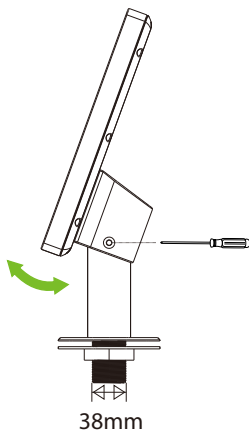

4 Standalone Installation

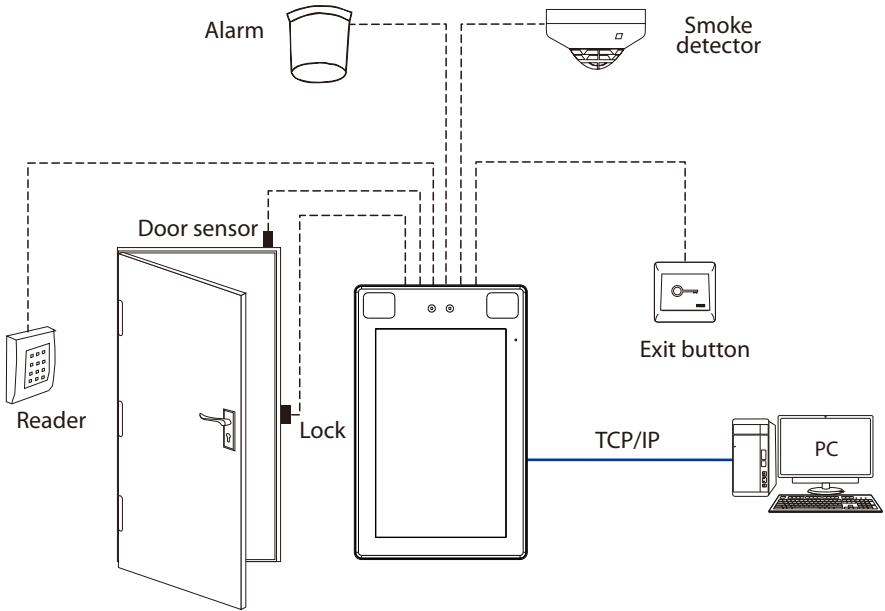

5 Door Sensor, Exit Button & Alarm Connection

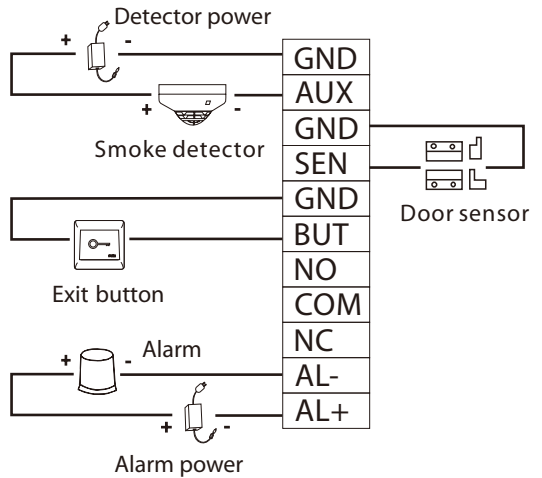
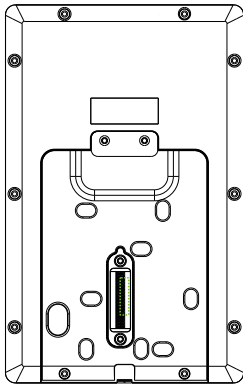

6 Lock Relay Connection

The system supports Normally Opened Lock and Normally Closed Lock. The NO LOCK (normally unlocked when power-on) is connected with 'NO' and 'COM' terminals, and the NC LOCK (normally locked when power-on) is connected with 'NC' and 'COM' terminals. Take NC Lock as an example below:

1) Device not sharing power with the lock

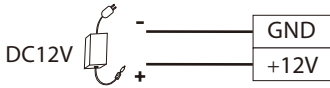

Maximum 30V 3A input.

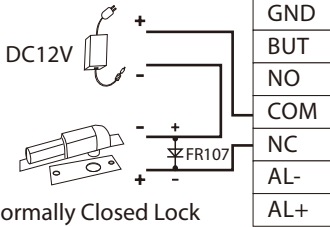

Normally Closed Lock

Do not reverse the polarity.

2) Device sharing power with the lock

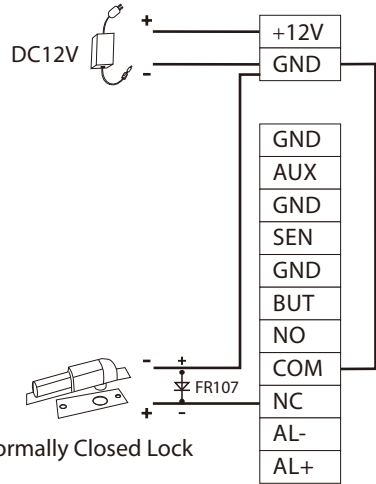

Normally Closed Lock

7 Wiegand Reader Connection

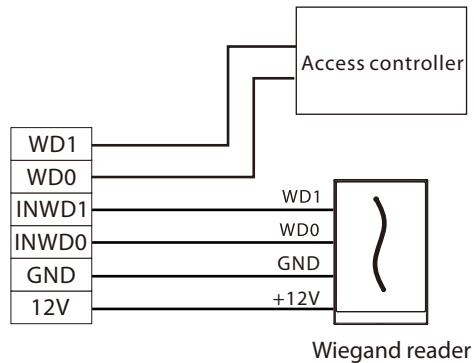
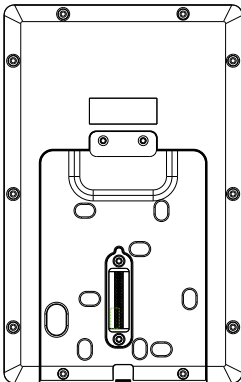

8 Barrier Connection

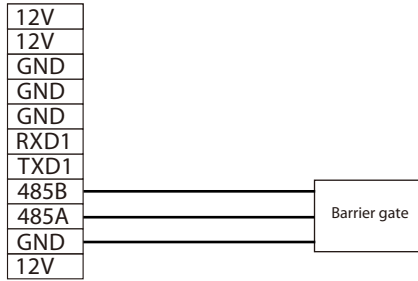
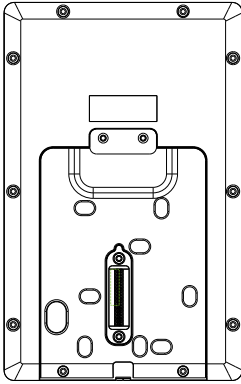

9 RS485 Connection

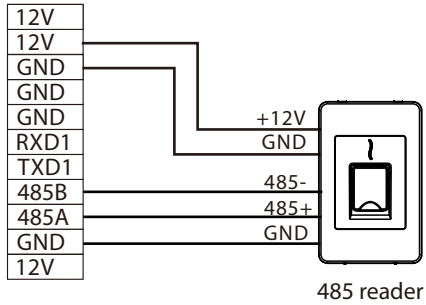
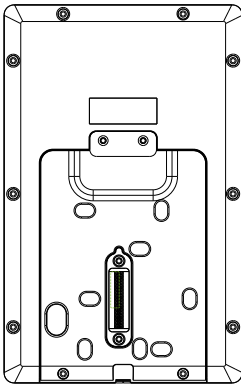

Note: 485A and 485B can be connected to the barrier gate or the 485 reader, but cannot be connected to the gate and the reader at the same time.

10 Power Connection

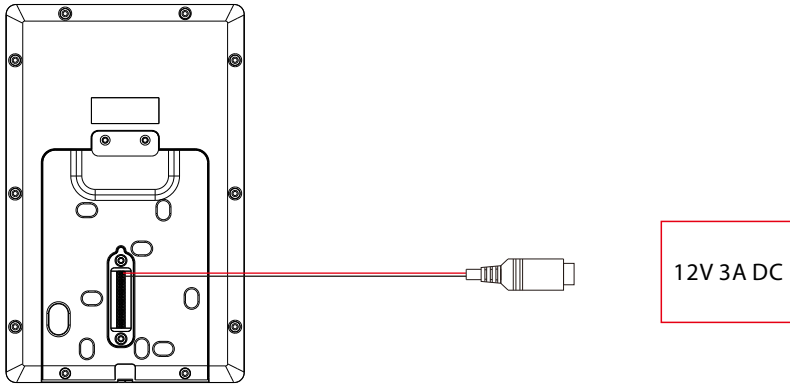

- Recommended power supply: 12V - 3A
- To share the power with other devices, use a power supply with higher current ratings.

11 Ethernet Connection

Connect the device and computer software over an Ethernet cable. An example is shown below:

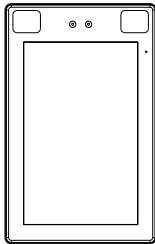

Default IP address: 192.168.1.201
Subnet mask: 255.255.255.0



IP address: 192.168.1.130
Subnet mask: 255.255.255.0

Note: In LAN, IP addresses of the server (PC) and the device must be in the same network segment when connecting to ZKBioAccess software.

Click on [Comm.] > [Ethernet] > [IP Address], input the IP address and click on [OK].

12 User Registration

When there is no super administrator set in the device, click on  to enter the menu. After setting the super administrator, the system will request for the administrator's verification before entering the menu. For the security purpose, it is recommended to register a super administrator at the first time you use the device.

Method1: Register on the device

Click on  > [User Mgt.] > [New User] to register a new user. Settings include entering user ID and name, registering palm, face, password and user photo, setting user role and access control role.

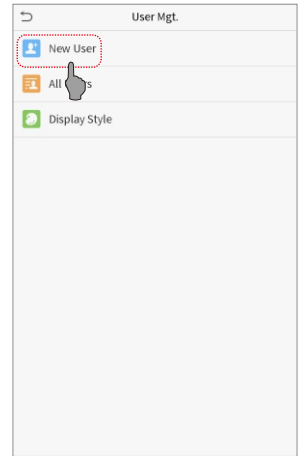
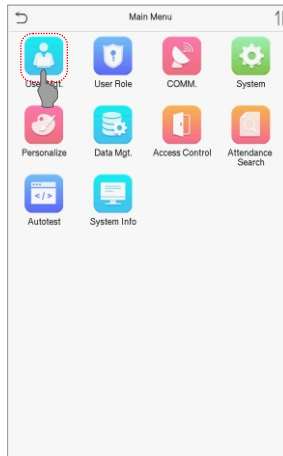
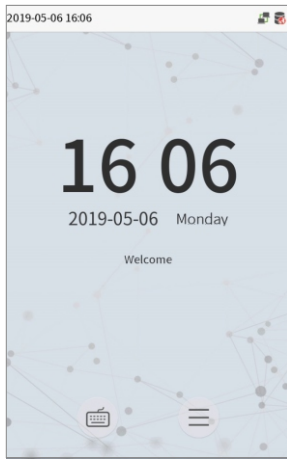

New User	
User ID	3
Name	
User Role	Normal User
Palm	0
Face	0
Password	
User Photo	0
Access Control Role	

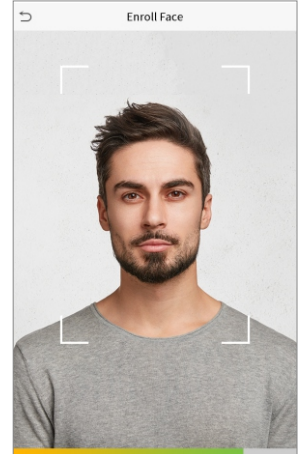

Method2: Register on ZKBioAccess software

Please set the IP address and cloud service server address on the device.

1. Click on [Access] > [Access Device] > [Device] > [Search Device] to add the device the software.
When the device has set the server address and port, it can be added automatically.

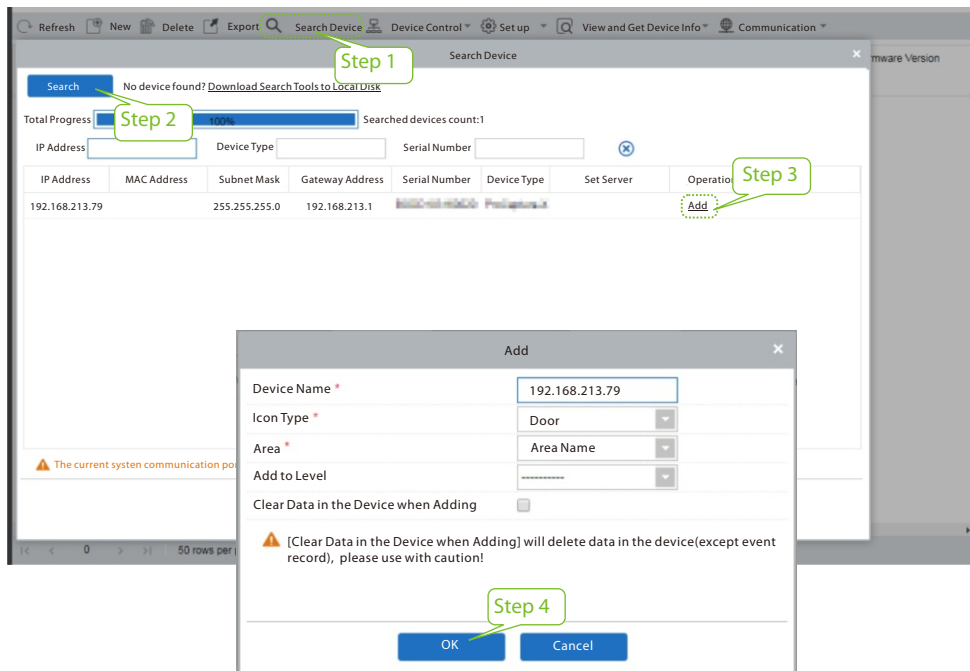

2. Click [Personnel] > [Person] > [New] to register users in the software.
3. Add users to access levels.
4. Click [Access] > [Device] > [Device Control] > [Synchronize All Data to Devices].

For more details, please refer to the ZKBioAccess User Manual.

Method 3: Register on the phone

Once ZKBioAccess software installed, users could enroll face via browser application on their own mobile phone.

1. Click [Personnel] > [Parameters], input “http://Server address:Port” in the QR Code UGL bar. The software will automatically generates a QR code. Scan the QR code or login onto “http://Server address:Port/app/v1/adreg” by the mobile phone to register users.

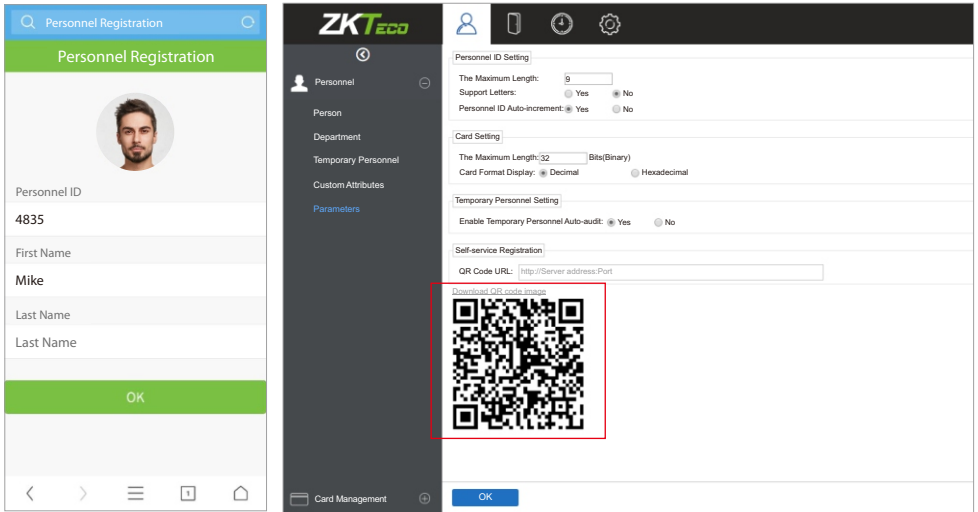

2. The users will display in [Personnel] > [Temporary Personnel], click [Review].

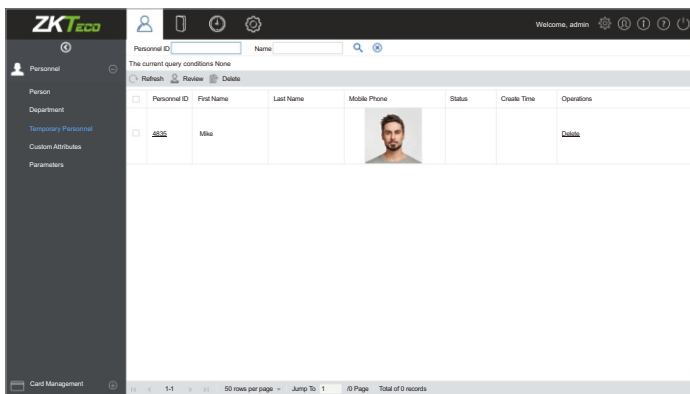



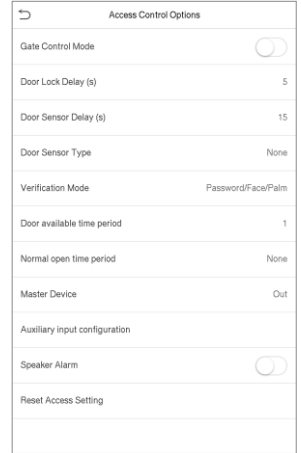
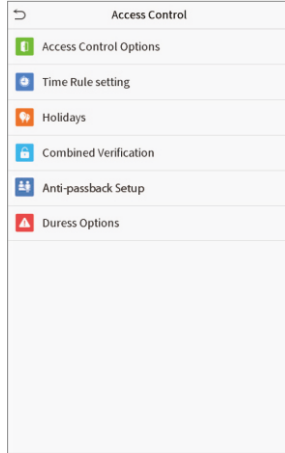
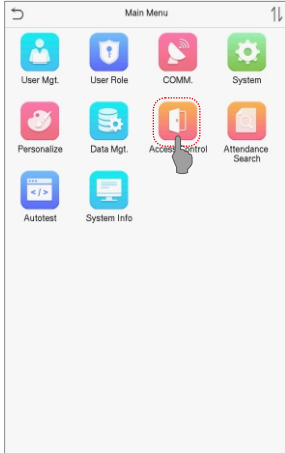

13 Access Control Settings

Click on  > [Access Control] to enter the access control management interface and set relevant parameters of access control.



14 Ethernet and Cloud Server Settings

Click on  > [Comm.] > [Ethernet] to set the network parameters. If the TCP/IP communication of the device is successful, the icon  will be displayed in the upper right corner of the standby interface.

Click on  > [Comm.] > [Cloud Server Setting] to set the server address and server port, that is, the IP address and port number of the server after the software is installed. If the device communicates with the server successfully, the icon  will be displayed in the upper right corner of the standby interface.

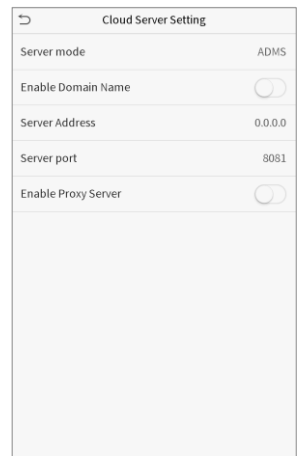
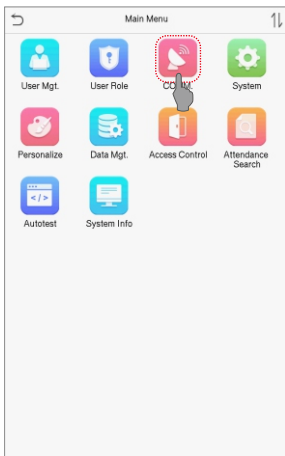

15 Method for Enrolling Palm

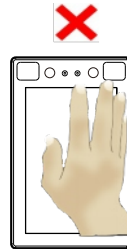
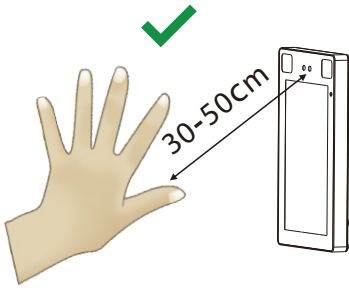

Note:

1. Place your palm within **30-50**cm of the device.
2. Place your palm in the palm collection area, such that the palm is placed parallel to the device.
3. Make sure to keep space between your fingers.

Green Label

ZKTeco Industrial Park, No. 26, 188 Industrial Road,
Tangxia Town, Dongguan, China.

Phone: +86 769-82109991

Fax: +86 755-89602394

www.zkteco.com

