

Quick Start Guide

SpeedFace - V5L[TI]

Version: 1.0

Overview

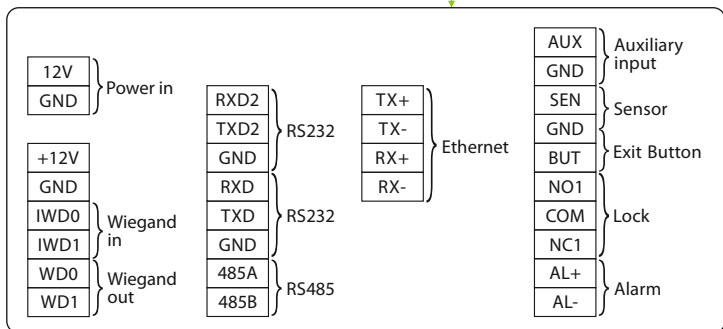
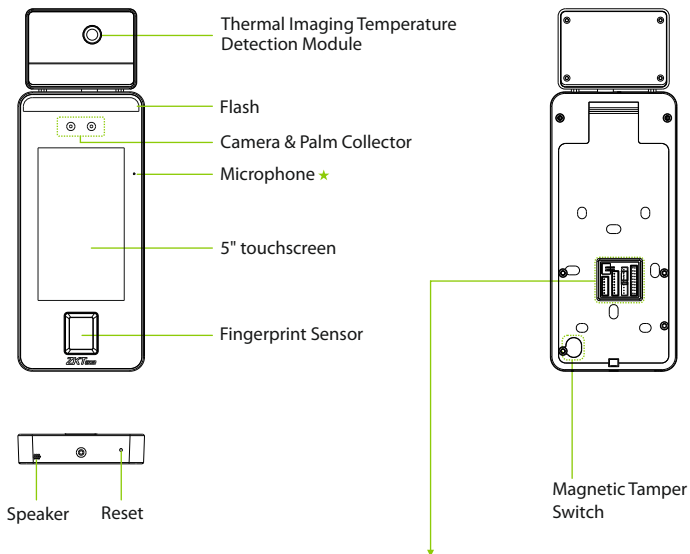

Note: Not all products have the function with ★, the real product shall prevail.

Installation Environment

Please refer to the following recommendations for installation.



INSTALL INDOORS
ONLY

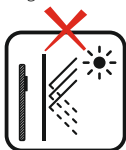

AVOID INSTALLATION
NEAR
GLASS WINDOWS

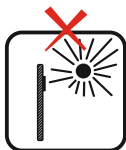

AVOID DIRECT
SUNLIGHT
AND EXPOSURE



AVOID USE OF ANY
HEAT SOURCE
NEAR THE DEVICE

Recommended Palm Gestures

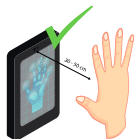

KEEP EFFECTIVE
DISTANCE OF
30-50 cm



KEEP SPACES
BETWEEN
YOUR FINGERS



DO NOT KEEP
YOUR FINGERS
CLOSE



DO NOT KEEP
PALM OUTSIDE
COLLECTION AREA



DO NOT KEEP
YOUR FINGERS
FOLD/CURLED

Note:

1. Place your palm within **30-50 cm** of the device.
2. Place your palm in the palm collection area, such that the palm is placed parallel to the device.
3. Make sure to keep space between your fingers.

Recommended Standing Position

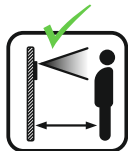

KEEP EFFECTIVE
DISTANCE OF
0.3-2m

Installation Requirements

The installation requirements and indications associated with the device are given below:

Specification	Standard value	Remark
Operating Environment	Indoor, Avoid wind, Avoid direct sunlight, 16°C to 35°C (60.8°F to 95°F)	The recommended operating temperature is 25°C (77°F)
Distance (between face and device)	30 to 120cm (0.98ft to 3.94ft)	The recommended distance is 80cm (2.62ft)
Measurement Accuracy	$\pm 0.3^{\circ}\text{C}$ ($\pm 0.54^{\circ}\text{F}$)	This value is tested at a distance of 80cm or 2.63ft under 25°C (77°F) environment.

Notes: The temperature measurement data is only for reference, and not for any medical purposes.

Forehead Temperature Detection

Indoor constant Temperature Environment

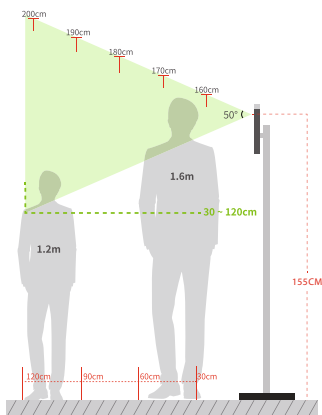

- Installation height: 1.55m
- FOV (Field Of View) of the thermal imaging device: 50°
- Temperature detection distance: 0.3m to 1.2m
- Height of the face adapted for detection: 1.2m to 2m

Device Installation

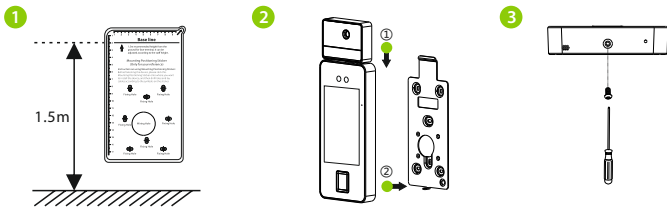

- ① Attach the mounting template sticker to the wall, and drill holes according to the mounting paper. Fix the back plate on the wall using wall mounting screws.
- ② Attach the device to the back plate.
- ③ Fasten the device to the back plate with a security screw.

Standalone Installation

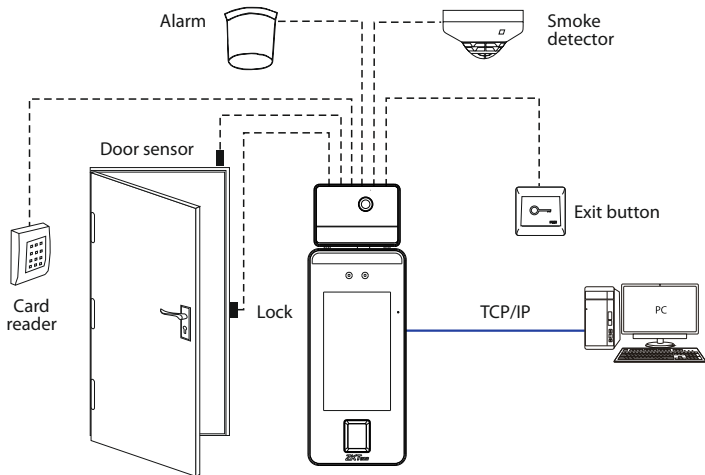

Power Connection

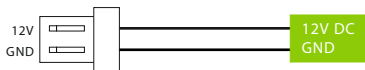
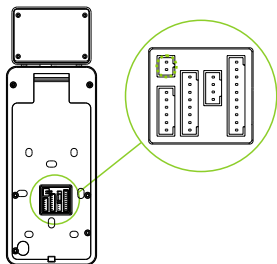

Recommended power supply

- 1) 12V \pm 10%, at least 3000mA.
- 2) To share the power with other devices, use a power supply with higher current ratings.

Ethernet Connection

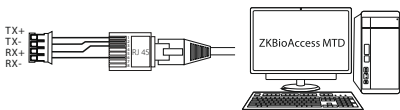
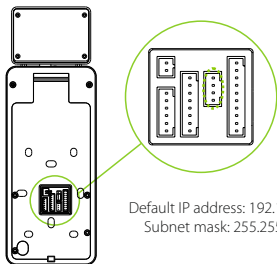

IP address: 192.168.1.130
Subnet mask: 255.255.255.0

Click [COMM.] > [Ethernet] > [IP Address], input the IP address and click [OK].

Note: In LAN, IP addresses of the server (PC) and the device must be in the same network segment when connecting to ZKBioAccess MTD software.

Door Sensor, Exit Button & Alarm Connection

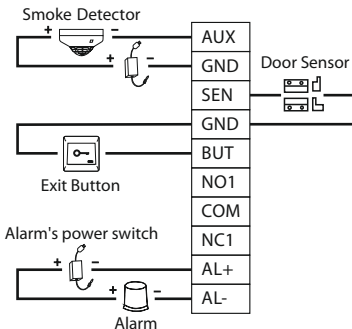
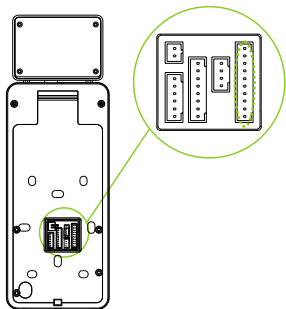

Lock Relay Connection

The system supports both **Normally Opened Lock** and **Normally Closed Lock**. The **NO Lock** (normally opened when powered) is connected with 'NO1' and 'COM' terminals, and the **NC Lock** (normally closed when powered) is connected with 'NC1' and 'COM' terminals. The power can be shared with the lock or can be used separately for the lock, as shown in the example with NC Lock below:

1) Device not sharing power with the lock

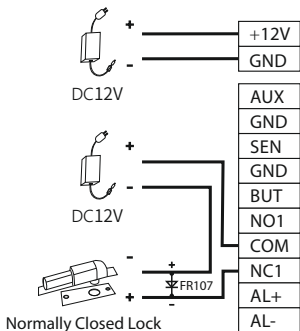

2) Device sharing power with the lock

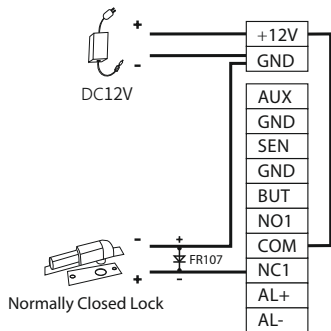

Wiegand Reader Connection

Wiegand card reader connects to the top 4 pins of the wiegand terminal and the last two pins are used by the Access controller, as shown in the following figure. It sends the credentials to the device via wiegand communication.

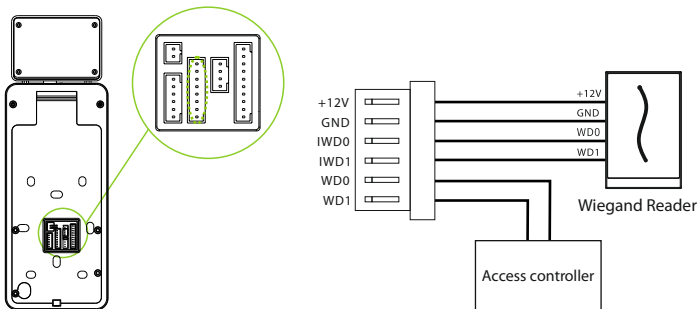

RS485 and RS232 Connection

The RS485 and the RS232 lets user connect to multiple readers to the device. Two RS232 and one RS485 can be connected to the terminal, as shown in the figure below.

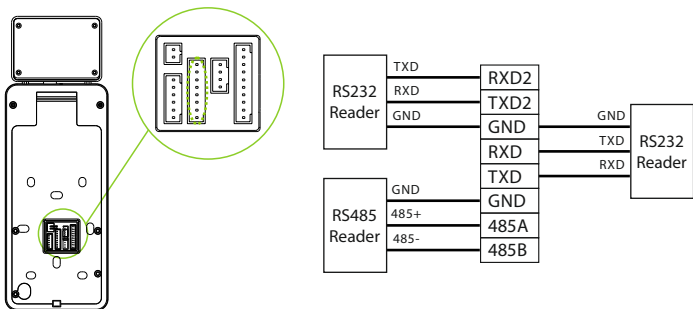

User Registration

When there is no super administrator set in the device, click on ☰ to enter the menu. Add a new user and set User Role to Super Admin, then the system will request for the administrator's verification before entering the menu. It is recommended to register a super administrator initially for security purposes.

Method 1: Register on the device

Click on ☰ > [User Mgt.] > [New User] to register a new user. The options include entering the user ID and Name, setting User Role, registering Palm, Fingerprint, Face, Password, Badge (optional), and adding User Photo.

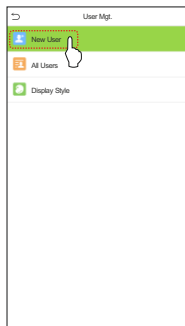
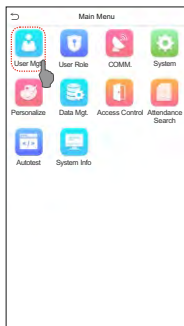
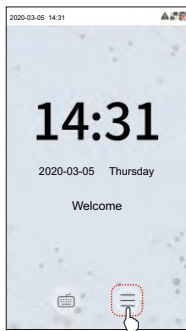

New User	
User ID	1
Name	Mike
User Role	Normal User
Palm	1
Fingerprint	1
Face	1
Password	*****
User Photo	1
Access Control Role	



Method 2: Register on ZKBioAccess MTD software

Please set the IP address and cloud service server address in the Comm. Menu option on the device.

1. Click **[Access]** > **[Access Device]** > **[Device]** > **[Search Device]** to search the device on the software. When an appropriate server address and port is set on the device, the searched devices are displayed automatically.

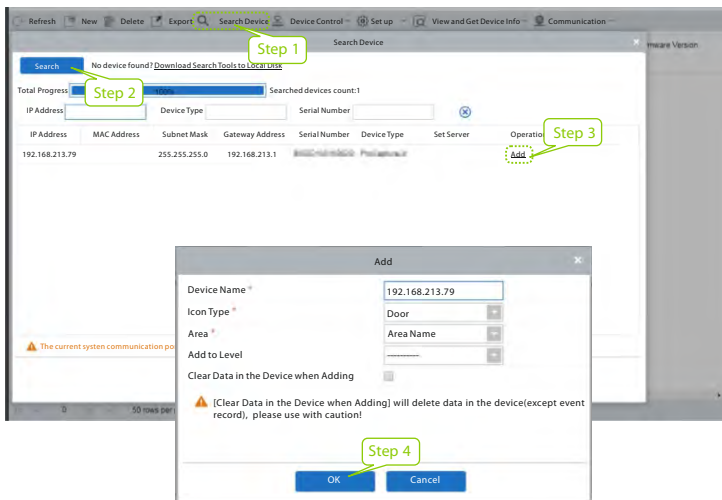

2. Click **[Add]** in operation column, a new window will pop-up. Select Icon type, Area, and Add to Level from each dropdowns and click **[OK]** to add the device.
3. Click **[Personnel]** > **[Person]** > **[New]** and fill in all the required fields to register a new users in the software.
4. Click **[Access]** > **[Device]** > **[Device Control]** > **[Synchronize All Data to Devices]** to synchronize all the data to the device including the new users.

For more details, please refer to the ZKBioAccess MTD User Manual.

Method 3: Register on the phone

Once the ZKBioAccess MTD software is installed, the users could enroll their face via a browser application on their own mobile phone.

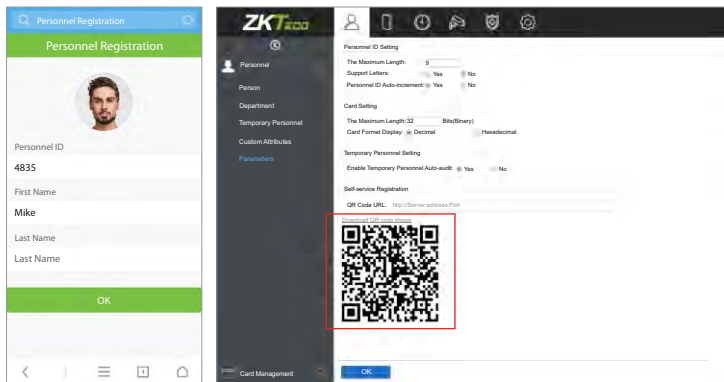

1. Click **[Personnel]** > **[Parameters]**, input "http://Server address: Port" in the QR Code UGL bar. The software will automatically generate a QR code. Scan the QR code or login onto "http://Server address: Port/app/v1/adreg" by the mobile phone to register users.



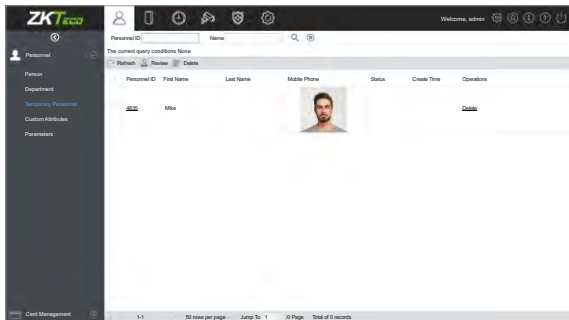

2. The users will be displayed in **[Personnel]** > **[Temporary Personnel]**, click on **[Review]** option and assign a department and click **[OK]** to successfully add the user.



Ethernet and Cloud Server Settings

Click on  > [COMM.] > [Ethernet] to set the network parameters. If the TCP/IP communication of the device is successful, the icon  will be displayed in the upper right corner of the standby interface.

Click on  > [COMM.] > [Cloud Server Setting] to set the server address and server port, that is, the IP address and port number of the server after the software is installed. If the device communicates with the server successfully, the icon  will be displayed in the upper right corner of the standby interface.

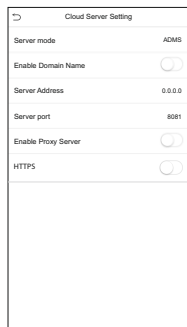
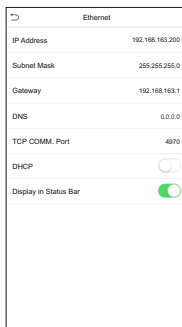
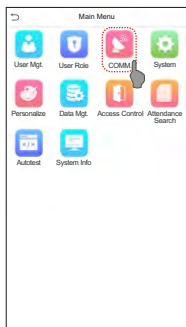

Note:

While pairing the device with ZKBioAccess MTD software. Make sure that the option **Enable Domain Name** is disabled and the correct server address and port are entered.

Server address: Set as the IP address of the ZKBioAccess MTD server.

Server port: Set as the service port of ZKBioAccess MTD (the default is 8088).

Access Control Setting

Click on ☰ > [Access Control] to enter the access control management interface and set relevant parameters of access control.

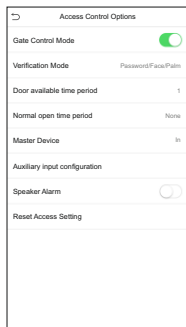
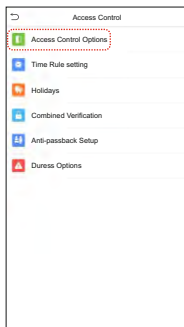
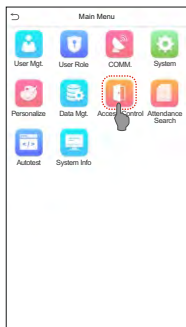

Attendance Record

Click on ☰ > [Attendance Search] > [Attendance Record] to enter the records query interface, input the user ID and select the time range, the corresponding attendance logs will be displayed.

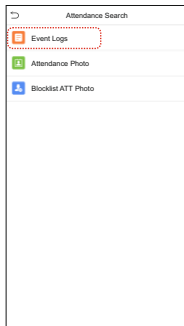
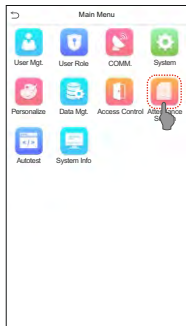

The Personal Record Search screen displays a table of attendance records. The table has columns for Date, User ID, and Access records.

Date	User ID	Access records
03-03		Number of Records:04
	4	11:25
	2	11:25 11:22
	3	11:25
03-04		Number of Records:04
	1	11:29
	3	11:29 11:21
	2	11:28
	4	11:26
03-05		Number of Records:04
	1	11:27
	4	11:27
	3	11:27
	2	11:27

Detection Management Settings

Click on ☰ > [System] > [Detection Management] to enter the setting interface.

- 1 You can set the value of **High temperature alarm threshold**, and enable the **Temperature over the range; access denied** and the **Trigger external alarm**, the device will send an alarm prompt when the temperature of the user detected exceeds this value, meanwhile the user will be forbidden to access, as shown in the following figure. The method of enabling **Mask detection** is the same.
- 2 When the **Allow unregistered people to access** is enabled, optionally, set **Enable capture of unregistered person** to save the temperature data.

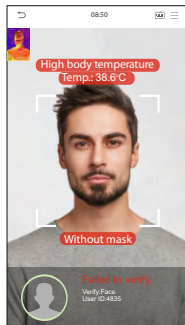
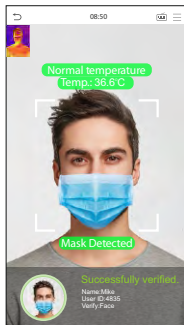
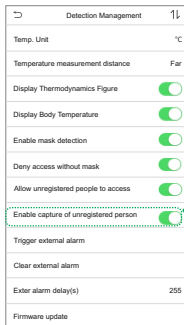
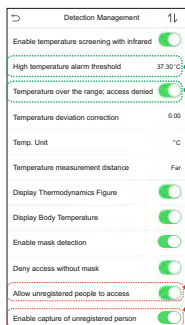
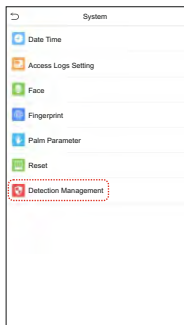
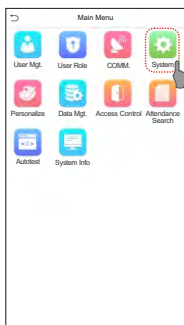

Notes:

1. The effective distance for temperature detection is within 50cm.
2. Recommended for indoor use.
3. Temperature measurement data is for reference only, not for medical use.
4. Remove the mask to register the face, wear a mask to recognize the face, the type of mask, the size of the face covered by the mask, and bangs will affect the facial recognition effect.
5. Facial verification for masked individuals will increase FAR. Palm verification for masked individuals is recommended.

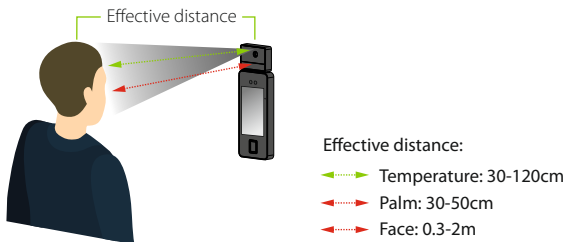

Real-time monitoring on the ZKBioAccess MTD software

Once ZKBioAccess MTD software installed, users could perform temperature detection management on browser.

1. Please set the IP address and cloud service server address on the device and add the device to the software.
2. Click **[Temperature Detection]** > **[Temperature Management]** > **[Real-time monitoring]** to view all the events include the Abnormal Temperature, No Masks and Normal Records.
3. Click **[Temperature Management]** > **[Statistics Panel]** to view the analysis of statistical data and view the personnels with normal temperature.

As shown in the following figure.

Real-Time Monitoring

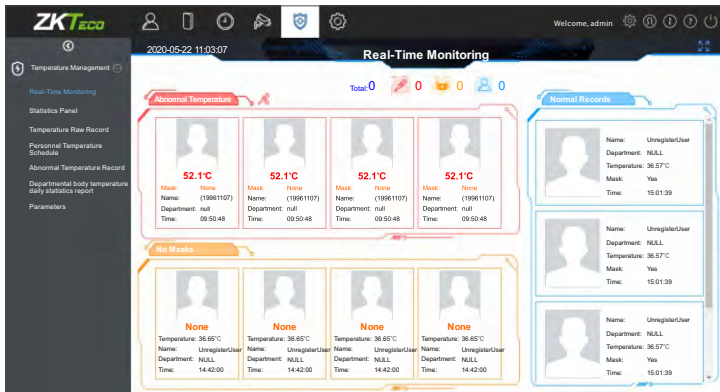

Statistics Panel

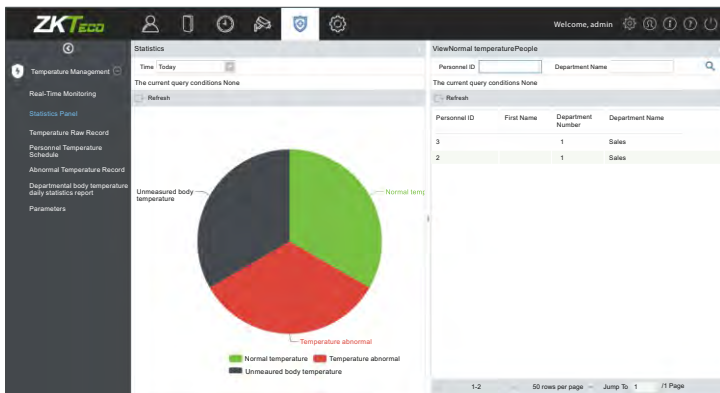

For more details, please refer to the ZKBioAccess MTD User Manual.

ZKTeco Industrial Park, No. 26, 188 Industrial Road,
Tangxia Town, Dongguan, China.

Phone : +86 769 - 82109991

Fax : +86 755 - 89602394

www.zkteco.com

