

User Manual

ZK-TD200

Date: June 2020

Doc Version: 1.0

English

Thank you for choosing our product. Please read the instructions carefully before operation. Follow these instructions to ensure that the product is functioning properly. The images shown in this manual are for illustrative purposes only.



For further details, please visit our Company's website
www.zkteco.com.

Copyright © 2020 ZKTECO CO., LTD. All rights reserved.

Without the prior written consent of ZKTeco, no portion of this manual can be copied or forwarded in any way or form. All parts of this manual belong to ZKTeco and its subsidiaries (hereinafter the "Company" or "ZKTeco").

Trademark

ZKTeco is a registered trademark of ZKTeco. Other trademarks involved in this manual are owned by their respective owners.

Disclaimer

This manual contains information on the operation and maintenance of the ZKTeco equipment. The copyright in all the documents, drawings, etc. in relation to the ZKTeco supplied equipment vests in and is the property of ZKTeco. The contents hereof should not be used or shared by the receiver with any third party without express written permission of ZKTeco.

The contents of this manual must be read as a whole before starting the operation and maintenance of the supplied equipment. If any of the content(s) of the manual seems unclear or incomplete, please contact ZKTeco before starting the operation and maintenance of the said equipment.

It is an essential pre-requisite for the satisfactory operation and maintenance that the operating and maintenance personnel are fully familiar with the design and that the said personnel have received thorough training in operating and maintaining the machine/unit/equipment. It is further essential for the safe operation of the machine/unit/equipment that personnel has read, understood and followed the safety instructions contained in the manual.

In case of any conflict between terms and conditions of this manual and the contract specifications, drawings, instruction sheets or any other contract-related documents, the contract conditions/documents shall prevail. The contract specific conditions/documents shall apply in priority.

ZKTeco offers no warranty, guarantee or representation regarding the completeness of any information contained in this manual or any of the amendments made thereto. ZKTeco does not extend the warranty of any kind, including, without limitation, any warranty of design, merchantability or fitness for a particular purpose.

ZKTeco does not assume responsibility for any errors or omissions in the information or documents which are referenced by or linked to this manual. The entire risk as to the results and performance obtained from using the information is assumed by the user.

ZKTeco in no event shall be liable to the user or any third party for any incidental, consequential, indirect, special, or exemplary damages, including, without limitation, loss of business, loss of profits, business interruption, loss of business information or any pecuniary loss, arising out of, in connection with, or

relating to the use of the information contained in or referenced by this manual, even if ZKTeco has been advised of the possibility of such damages.

This manual and the information contained therein may include technical, other inaccuracies or typographical errors. ZKTeco periodically changes the information herein which will be incorporated into new additions/amendments to the manual. ZKTeco reserves the right to add, delete, amend or modify the information contained in the manual from time to time in the form of circulars, letters, notes, etc. for better operation and safety of the machine/unit/equipment. The said additions or amendments are meant for improvement /better operations of the machine/unit/equipment and such amendments shall not give any right to claim any compensation or damages under any circumstances.

ZKTeco shall in no way be responsible (i) in case the machine/unit/equipment malfunctions due to any non-compliance of the instructions contained in this manual (ii) in case of operation of the machine/unit/equipment beyond the rate limits (iii) in case of operation of the machine and equipment in conditions different from the prescribed conditions of the manual.

The product will be updated from time to time without prior notice. The latest operation procedures and relevant documents are available on <http://www.zkteco.com>

If there is any issue related to the product, please contact us.

ZKTeco Headquarters

Address ZKTeco Industrial Park, No. 26, 188 Industrial Road,
Tangxia Town, Dongguan, China.

Phone +86 769 - 82109991

Fax +86 755 - 89602394

For business related queries, please write to us at: sales@zkteco.com.

To know more about our global branches, visit www.zkteco.com.

About the Company

ZKTeco is one of the world's largest manufacturer of RFID and Biometric (Fingerprint, Facial, Finger-vein) readers. Product offerings include Access Control readers and panels, Near & Far-range Facial Recognition Cameras, Elevator/floor access controllers, Turnstiles, License Plate Recognition (LPR) gate controllers and Consumer products including battery-operated fingerprint and face-reader Door Locks. Our security solutions are multi-lingual and localized in over 18 different languages. At the ZKTeco state-of-the-art 700,000 square foot ISO9001-certified manufacturing facility, we control manufacturing, product design, component assembly, and logistics/shipping, all under one roof.

The founders of ZKTeco have been determined for independent research and development of biometric verification procedures and the productization of biometric verification SDK, which was initially widely applied in PC security and identity authentication fields. With the continuous enhancement of the development and plenty of market applications, the team has gradually constructed an identity authentication ecosystem and smart security ecosystem, which are based on biometric verification techniques. With years of experience in the industrialization of biometric verifications, ZKTeco was officially established in 2007 and now has been one of the globally leading enterprises in the biometric verification industry owning various patents and being selected as the National High-tech Enterprise for 6 consecutive years. Its products are protected by intellectual property rights.

About the Manual

This manual introduces the operations of ZK-TD200 product.

All figures displayed are for illustration purposes only. Figures in this manual may not be exactly consistent with the actual products.

Document Conventions

Conventions used in this manual are listed below:

GUI Conventions

For Software	
Convention	Description
Bold font	Used to identify software interface names e.g. OK, Confirm, Cancel
>	Multi-level menus are separated by these brackets. For example, File > Create > Folder.
For Device	
Convention	Description
<>	Button or key names for devices. For example, press <OK>
[]	Window names, menu items, data table, and field names are inside square brackets. For example, pop up the [New User] window
/	Multi-level menus are separated by forwarding slashes. For example, [File/Create/Folder].

Symbols





Convention	Description
	This implies about the notice or pays attention to, in the manual
	The general information which helps in performing the operations faster
	The information which is significant
	Care taken to avoid danger or mistakes
	The statement or event that warns of something or that serves as a cautionary example.

Table of Contents

1	INSTALLATION INSTRUCTIONS	7
2	OVERVIEW.....	8
1.1	APPEARANCE.....	8
1.2	SPECIFICATIONS.....	10
1.3	INSTALLATION INSTRUCTIONS.....	11
1.3.1	INSTALLATION STEPS.....	11
3	STANDBY INTERFACE.....	13
4	TEMPERATURE MEASUREMENT INTERFACE	14
5	MAIN MENU	15
6	ALARM SET.....	16
7	PERSONALIZE	17
8	SYSTEM SET	18
9	PACKING LIST	19

1 Installation Instructions

Please follow the instructions carefully before installation.

It is mainly used indoors, and it is necessary to build a shelter if the device is used in an outdoor environment. The shelter must be constructed in such a way that that the device and users are inside the shelter. The persons coming to detect body temperature from outdoor or high-temperature rooms must wait for some time until the hair, body, clothes, and accessories get cool and then proceed to detect the body temperature.



INDOOR USE



KEEP DISTANCE



AVOID GLASS REFLECTION



AVOID DIRECT SUNLIGHT EXPOSURE

1. Do not point the temperature measuring camera at direct sunlight or any high-temperature source.
2. When the device is moved from one place to another with low-temperature or high-temperature difference, or when the device is installed and powered on for the first time, the device needs to work for some time to ensure that the temperature of the machine is consistent with the current temperature, and there is no temperature difference. For example, just install the device after taking it from the warehouse and wait for more than 15 minutes after the device is powered on to ensure that the temperature of the device is consistent with the current temperature.
3. After the device is normally powered on, it is not recommended to move the position of the temperature measurement sensor, otherwise, it may affect the detection accuracy.
4. Temperature measurement data is for reference only, not for medical use. This product is not suit for environment with strong light or high temperature. It is recommended to use this product indoors without wind.
5. During use, please place the person's wrist align the infrared temperature probe and cover the distance sensor.

2 Overview

1.1 Appearance

Front and Rear View

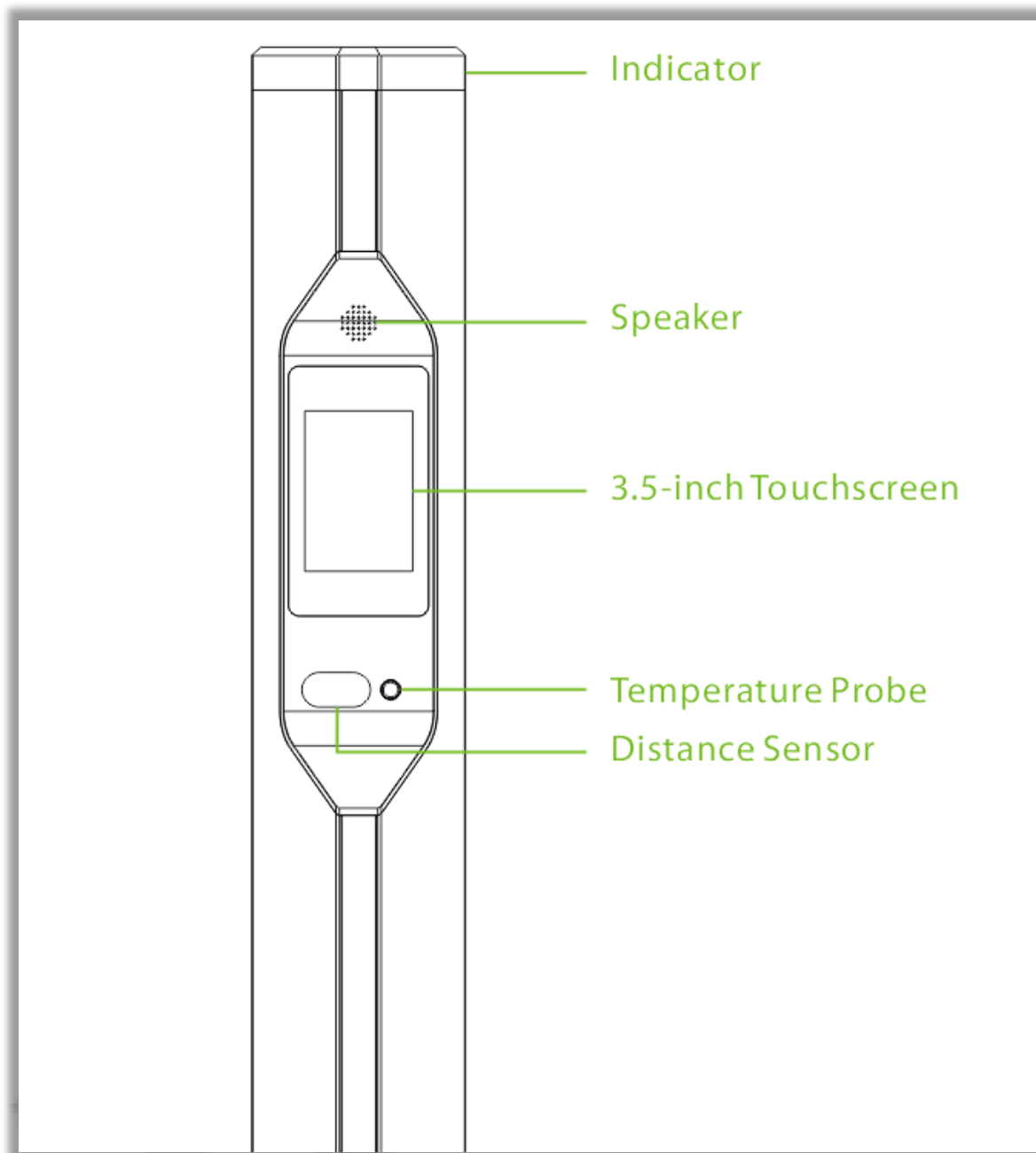

**Note:**

When the device is in standby status, the indicator is always yellow. If the temperature detected is abnormal, it flashes red. If the temperature detected is normal, it flashes green.

1.2 Specifications

Items	Description
Power	AC 100 ~ 120V/200 ~ 240V
Electrical Current	65mA
Standby Power	3.5W
Running Power	4.2W
Screen Size	3.5 inch
Screen Resolution	320 * 480
Working Temperature	16°C ~ 38°C (60.8°F ~ 100.4°F)
Working Environment	Indoor
Dimensions (L*W*H)	428 * 379 * 1484 (mm)
Packing Dimensions (L*W*H)	1445 * 505 * 290 (mm)
Weight with Packing (kg)	11.5
Temperature Sensor Type	IR temperature sensor
Temperature Measurement Time	≤1s
Temperature Measurement Point	Wrist
Temperature Measurement Distance	50mm ~ 100mm
Height of Temperature Probe from the Ground	1186mm (customizable)
Temperature Measurement Deviation	±0.5°C (±0.9°F)
Temperature Range	30°C ~ 45°C (86°F ~ 113°F)
Interval Between Temperature Measurement	2s

1.3 Installation Instructions

If you want to open the chassis, you should contact the agent for permission. Otherwise, you will bear any consequence resulting from your actions.

1.3.1 Installation Steps

Step 1: Fix the column with four screws at the bottom of the chassis.

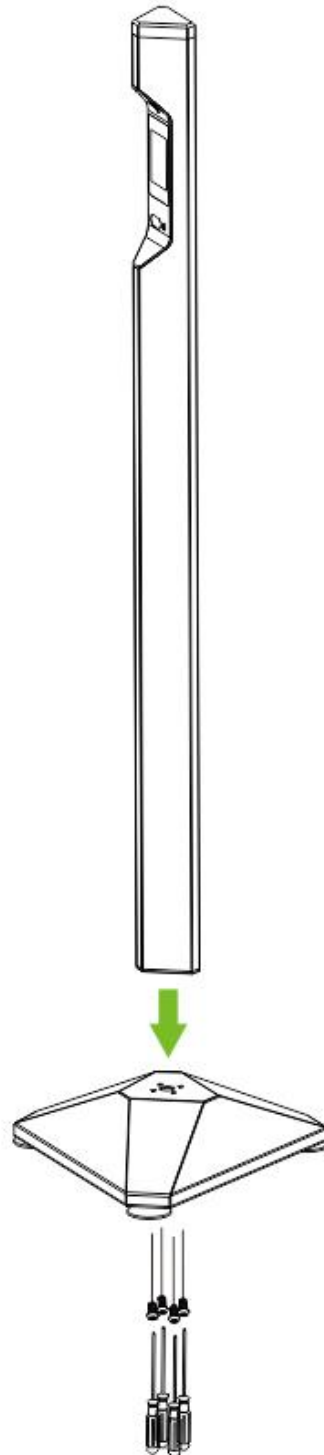

Step 2: Turn on the power.

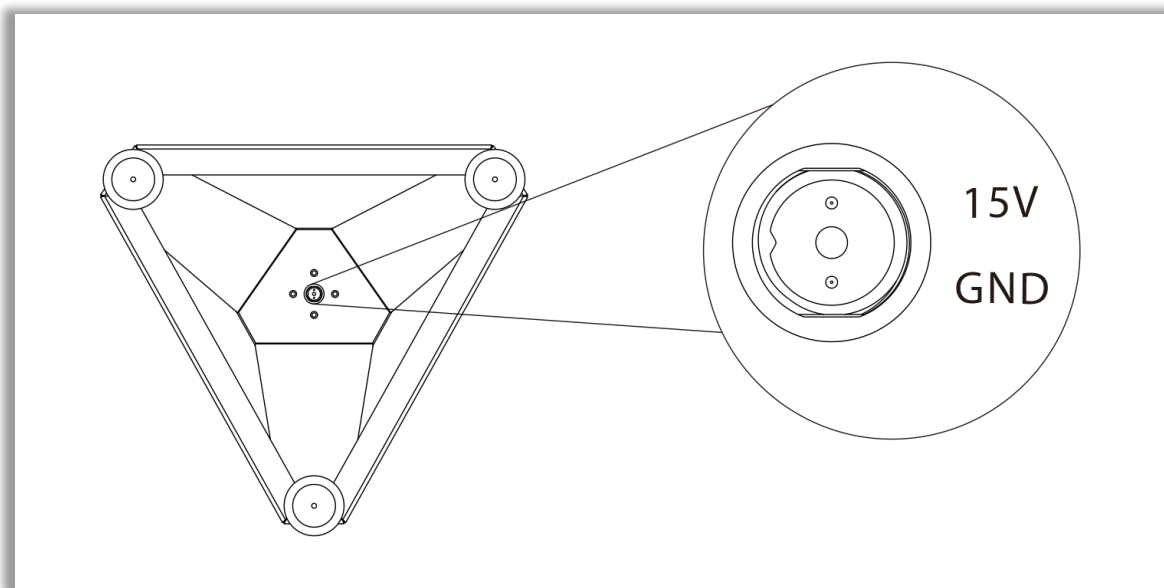

3 Standby Interface

The arrow in the picture points to the location of the temperature sensor.

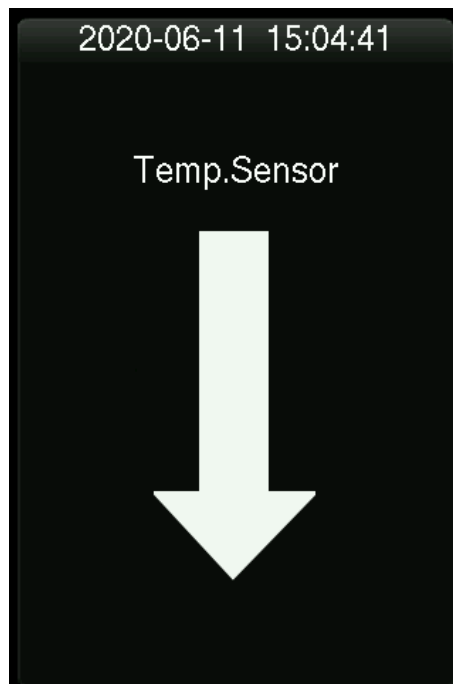

Touch the screen to display the main menu button.

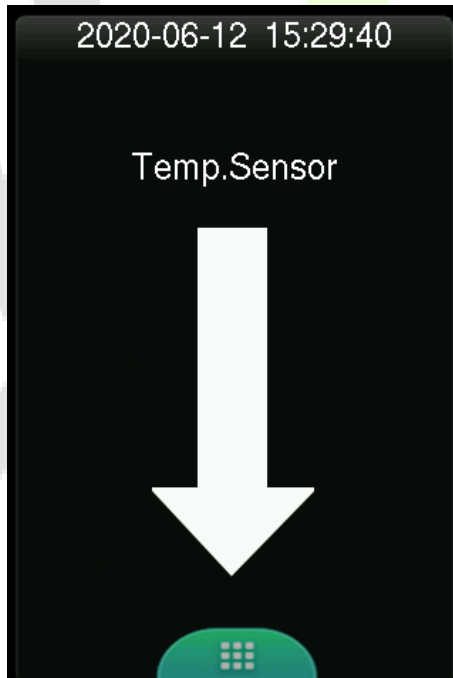

4 Temperature Measurement Interface

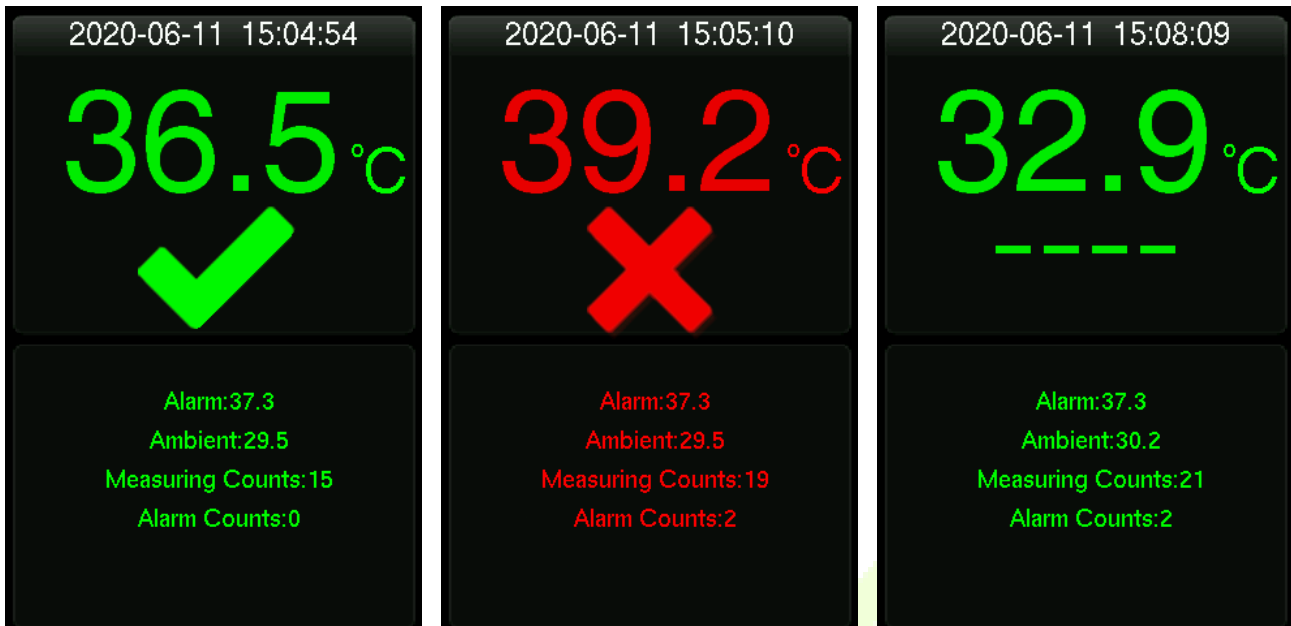

Normal Temperature

Abnormal Temperature

No Item measurement

Alarm: It is the standard value of temperature alarm.

Ambient: The ambient temperature where the device is at the time.

Measuring Counts: Number of temperature measurements.

Alarm Counts: Times of temperature alarms.

5 Main Menu

Press  on the standby interface to enter the main menu, as shown below:

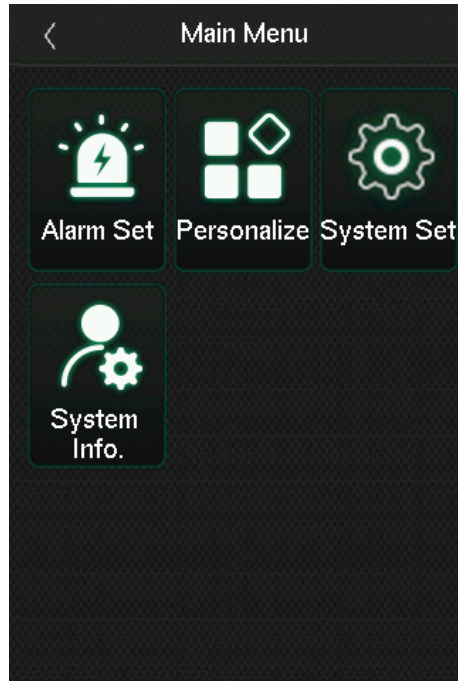

Items	Descriptions
Alarm Set	To set the alarm temperature, volume, times and ring tone.
Personalize	To set the sensor, temperature and voice prompt.
System Set	To set the temperature mode, language and date&time of the system.
System Info.	To view the serial number, device and firmware information of the current device.

6 Alarm Set

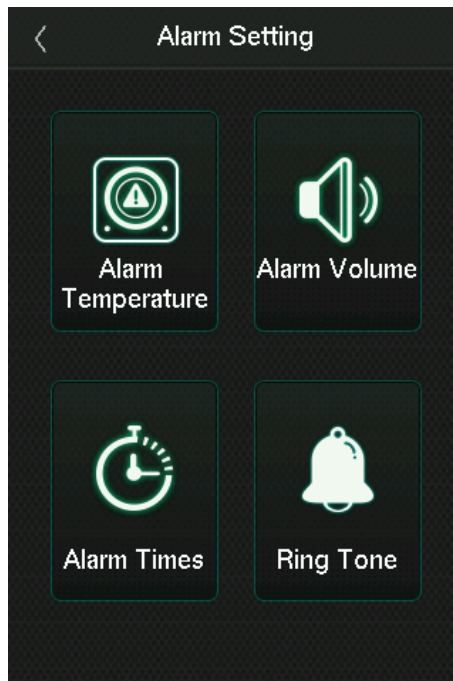

Items	Descriptions
Alarm Temperature	The alarm temperature can be set within 37.0-47.0°C (The default value is 37.3)
Alarm Volume	Set the volume of the alarm, 0 is to turn off the sound. (The default value is 10)
Alarm Times	Set the number of alarms when the alarm temperature value is reached.(The default value is 2)
Ring Tone	6 kinds of ring tones can be set. (The default value is ringtone 1)

7 Personalize

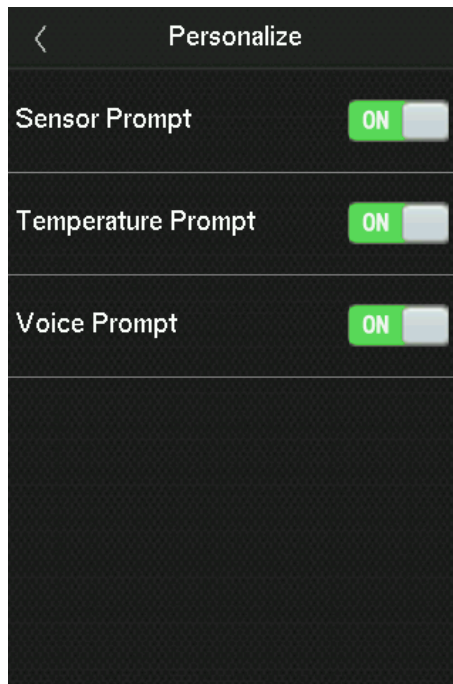

Items	Descriptions
Sensor Prompt	Set whether to display the direction indicator arrow during standby status(The default value is ON)
Temperature Prompt	Set whether to display specific temperature value when measuring temperature. (The default value is ON)
Voice Prompt	Set whether there is voice prompt during temperature measurement. (The default value is ON)

8 System Set

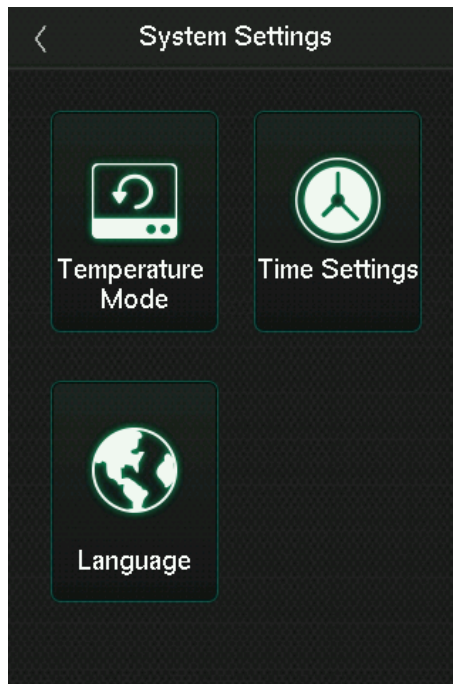

Items	Descriptions
Temperature Mode	Set the temperature mode as Celsius or Fahrenheit (The default value is Celsius)
Time Setting	You can manually set the date and time and click Confirm to save.
Language	Spanish, English and Chinese can be set. (The default value is English)

9 Packing List

NO	Component	Quantity
1	Pillar	1 set
2	Chassis (with foot cup*3)	1set
3	User Manual	1
4	Power Cord	1 pcs
5	Adapter	1 pcs
6	Phillips Screwdriver	1 pc
7	Hexagon Wrench	1 pc
8	Hexagon Screws	4 pc

ZKTeco Industrial Park, No. 26, 188 Industrial Road,

Tangxia Town, Dongguan, China.

Phone : +86 769 - 82109991

Fax : +86 755 - 89602394

www.zkteco.com

