

QUICK START GUIDE

Applicable Model:G3 Pro

Version: 1.0
Date: February 2020



Safety Precautions

Before installation, please read the following safety precautions for user safety and to prevent product damage.

- Do not install the device in a place subject to direct sun light, humidity, dust or soot.
- Do not place magnet near the device. Magnetic objects such as magnet, CRT, TV, monitor or speaker may damage the device.
- Do not place the device next to heating equipment.
- Do not leak liquid like water, drinks or chemicals inside the device.
- Do not let children touch the device without supervision.
- Do not drop or damage the device.
- Do not disassemble, repair or alter the device.
- Do not use the device for any purpose other than those specified.
- Clean the device often to remove dust on it. While cleaning, do not splash water on the device but wipe it out with smooth cloth or towel.

Contact your supplier in case of a problem!

1

User Registration

1) Recommended Standing Position

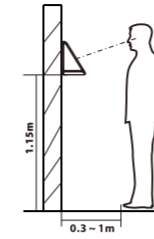

For user heights between 1.5m to 1.8m, it is recommended to install the device at 1.15m height above ground (may be modified according to user average height).

a. Recommended Registration and Verification Position

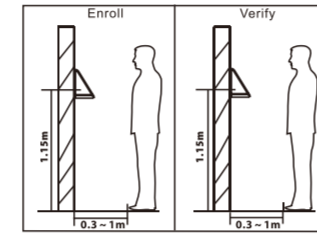

Recommended Procedures (as shown in the left image): During registration and verification procedures, the position of device should not be changed to prevent reduction in verification preciseness. If it is necessary to move the device, its vertical height should not be changed.

b. Factors Affecting the Preciseness of Verification

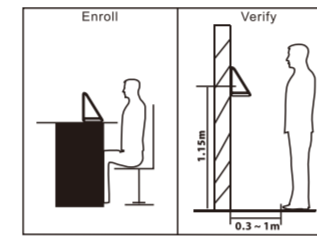

Non-identical registration and verification gestures

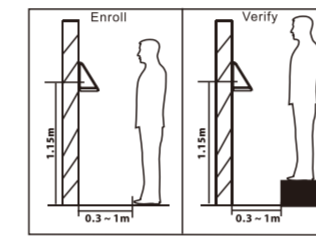

Non-identical registration and verification heights

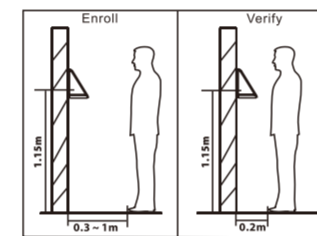

Non-identical registration and verification distances from device

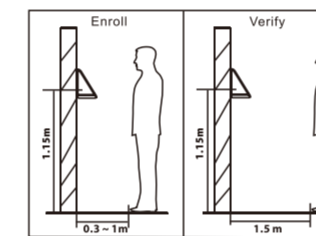

Non-identical registration and verification distances from device

2

User Registration

2) Recommended Facial Expressions:

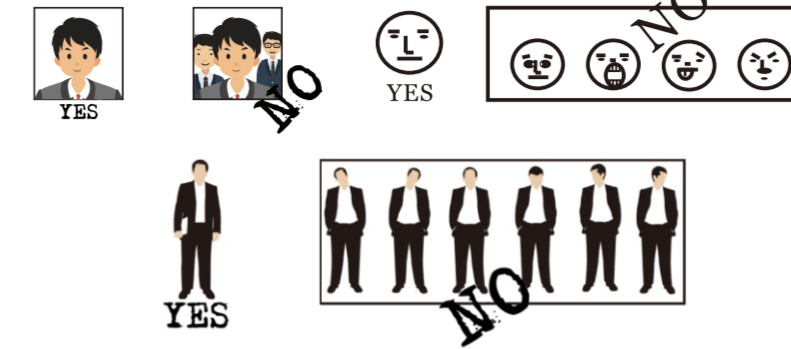

3) Registration

During registration, you need to move forward or backward to ensure that the face is displayed in the center of the screen. Stay still until the registration succeeds.



4) Method for Enrolling Palm

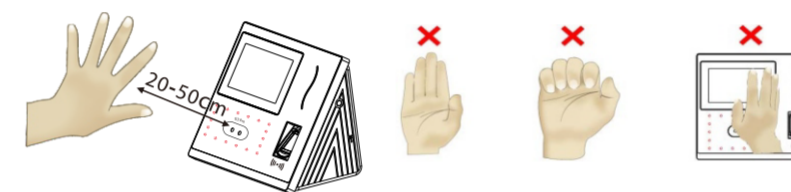

Place your palm in the palm collection area, such that the palm is placed parallel to the device. Make sure to keep space between your fingers.

3

Device Overview

Front

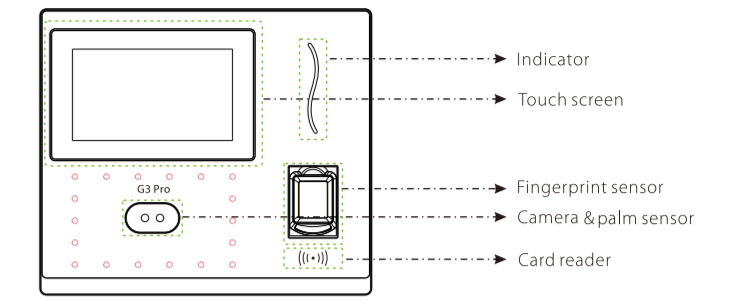

Left Side

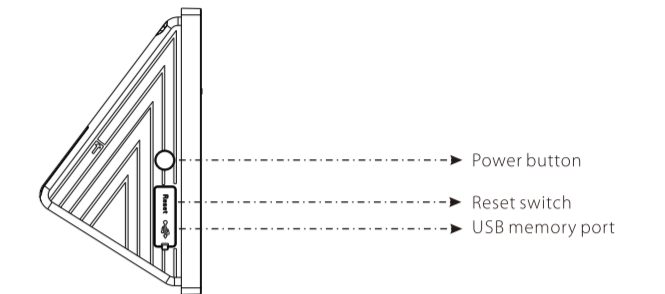

Back

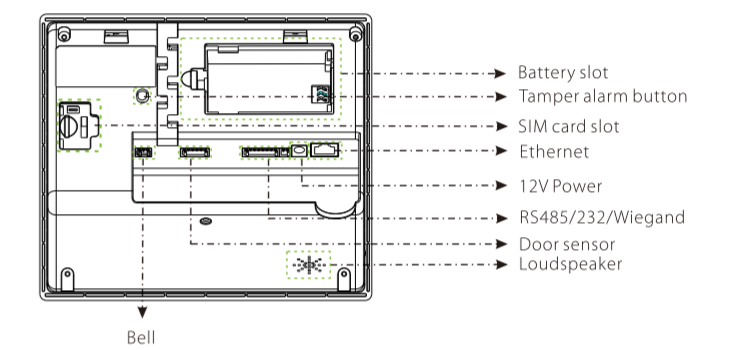

4

Device Dimensions & Installation

Product dimensions

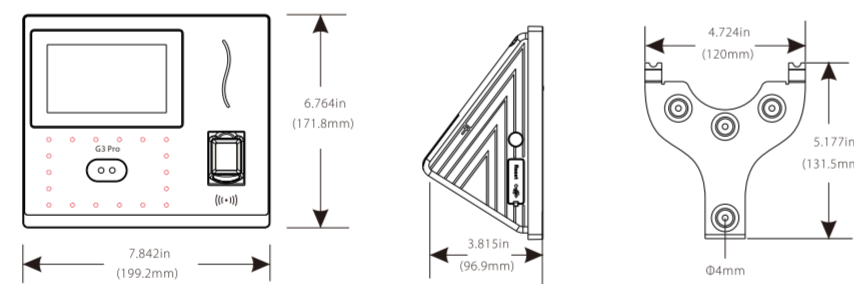

Mounting the device on wall

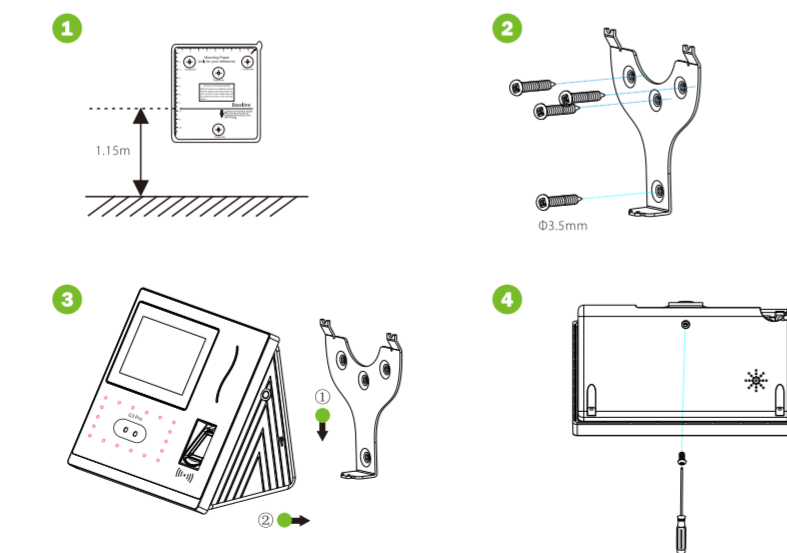

- 1 Paste the mounting template sticker onto the wall, and drill holes according to the mounting paper.
- 2 Fix the back plate onto the wall using wall mounting screws.
- 3 Insert the device into back plate.
- 4 Use security screw to fasten the device to back plate.

5

Bell Connection

External bell normally opened connection

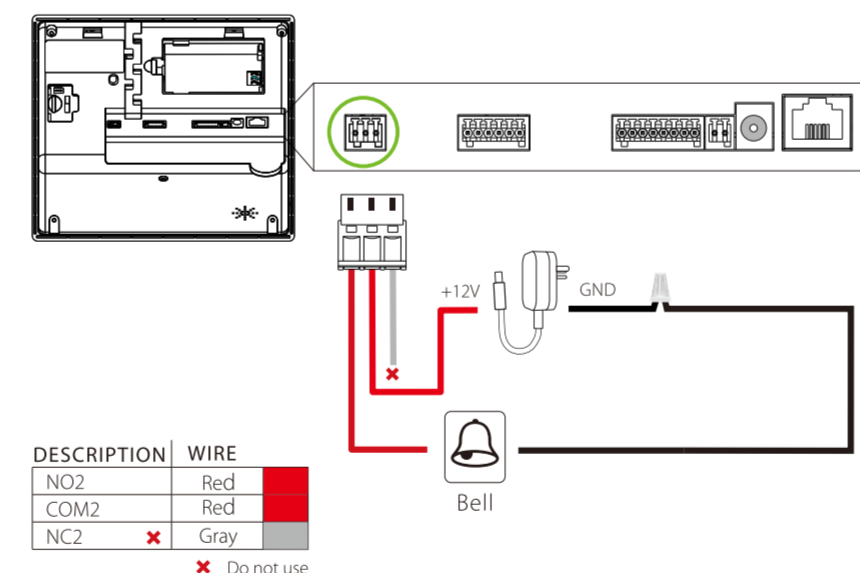

External bell normally closed connection

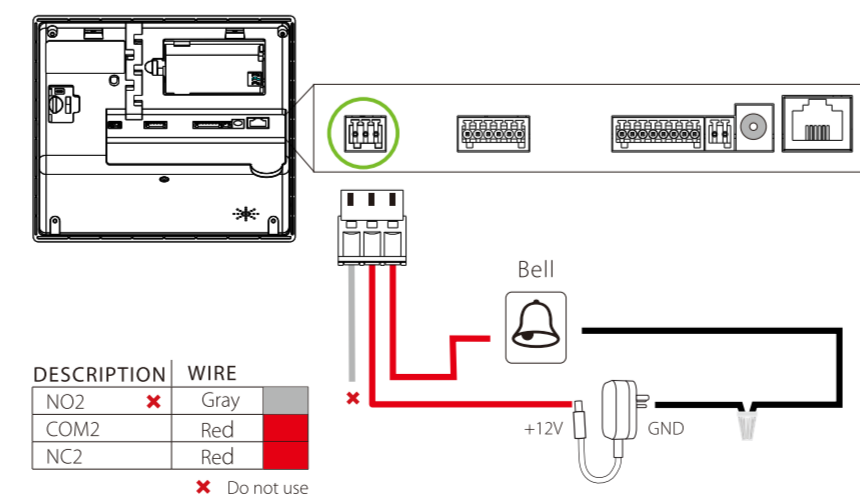

6

Lock Relay Connection

The system supports Normally Opened Lock (NO Lock) and Normally Closed Lock (NC Lock). Below is the connection diagram for NO Lock.

Device not sharing power with the lock

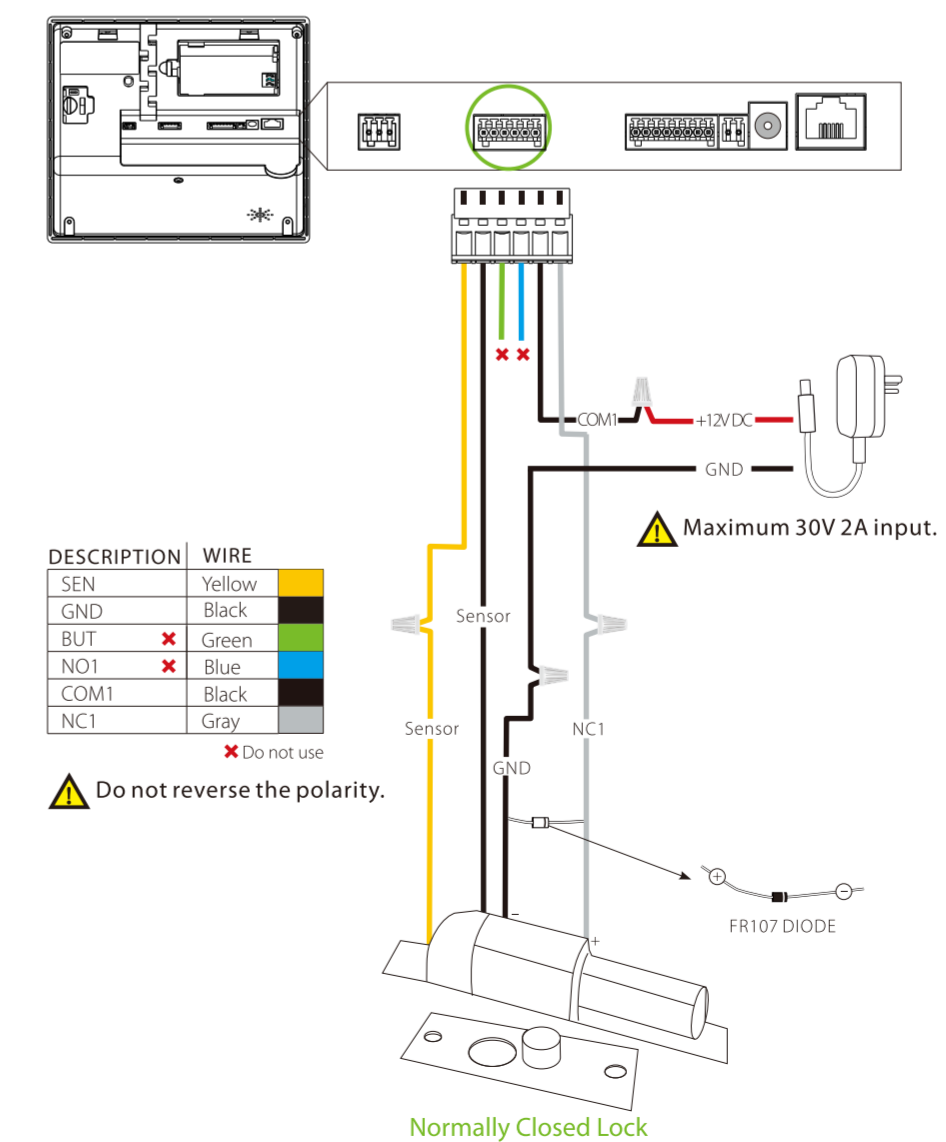

7

Lock Relay Connection

Device sharing power with the lock

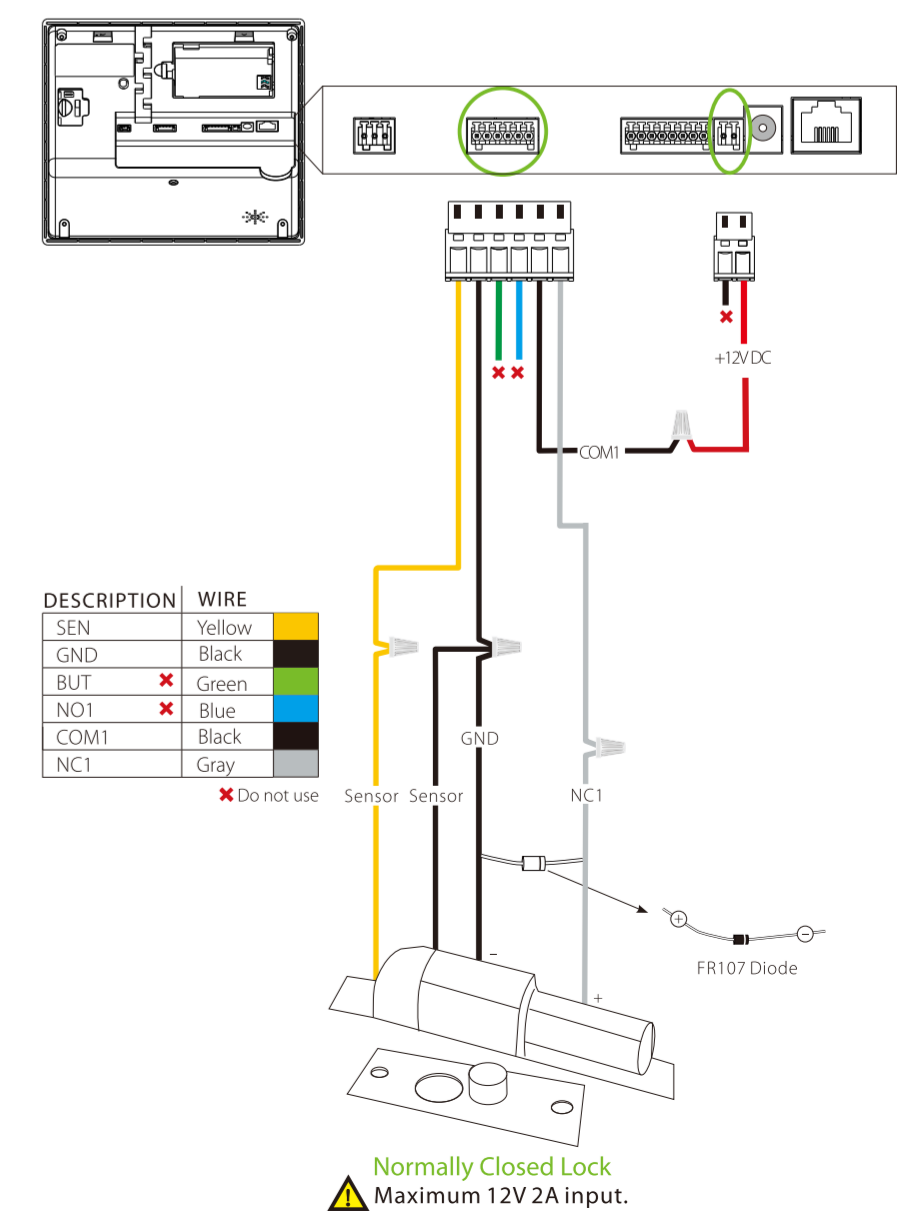

8



ZKTeco Industrial Park, No.26, 188 Industrial Road,
Tangxia Town, Dongguan, China
Tel: +86 769-82109991
Fax: +86 755-89602394
www.zkteco.com



Ethernet Connection

Connecting the device to PC via cross cable

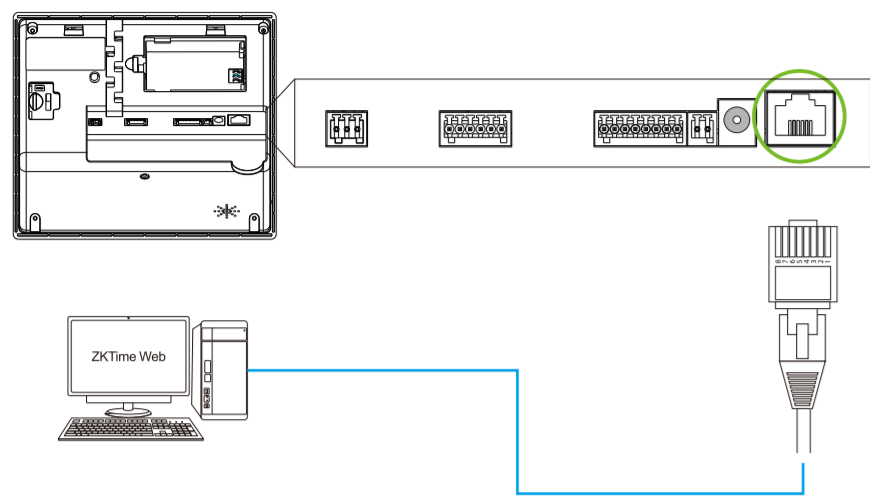

Connecting the device to PC via the CAT-5 cable and switch to create a local network

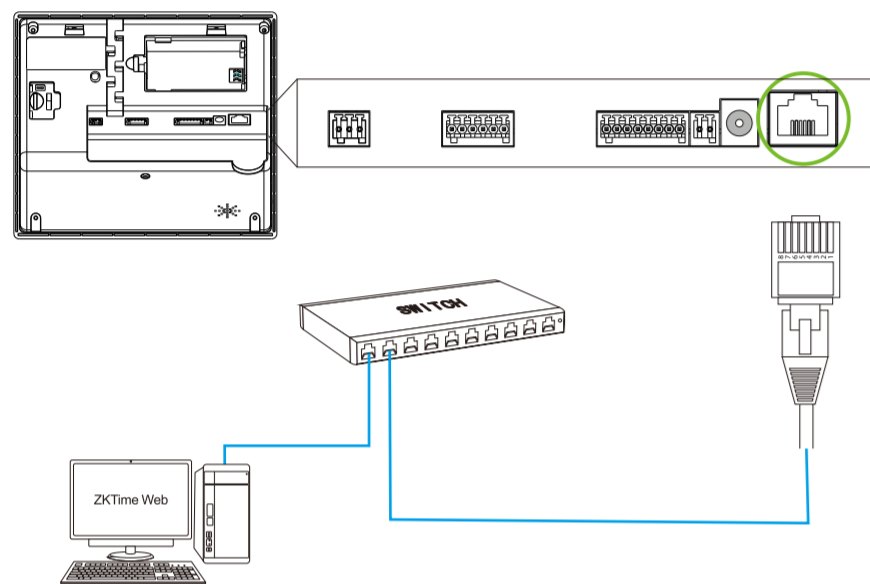

9

RS232 Connection

Printer connection

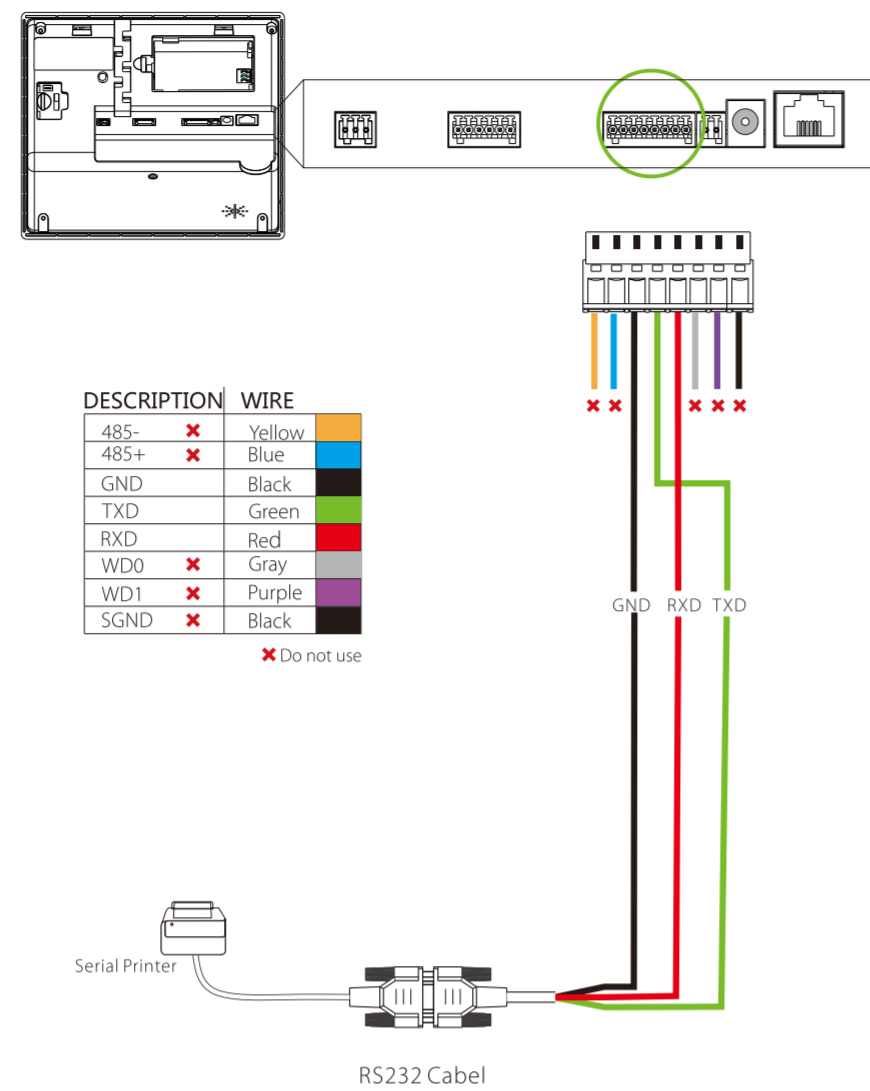

10

Wiegand Output Connection

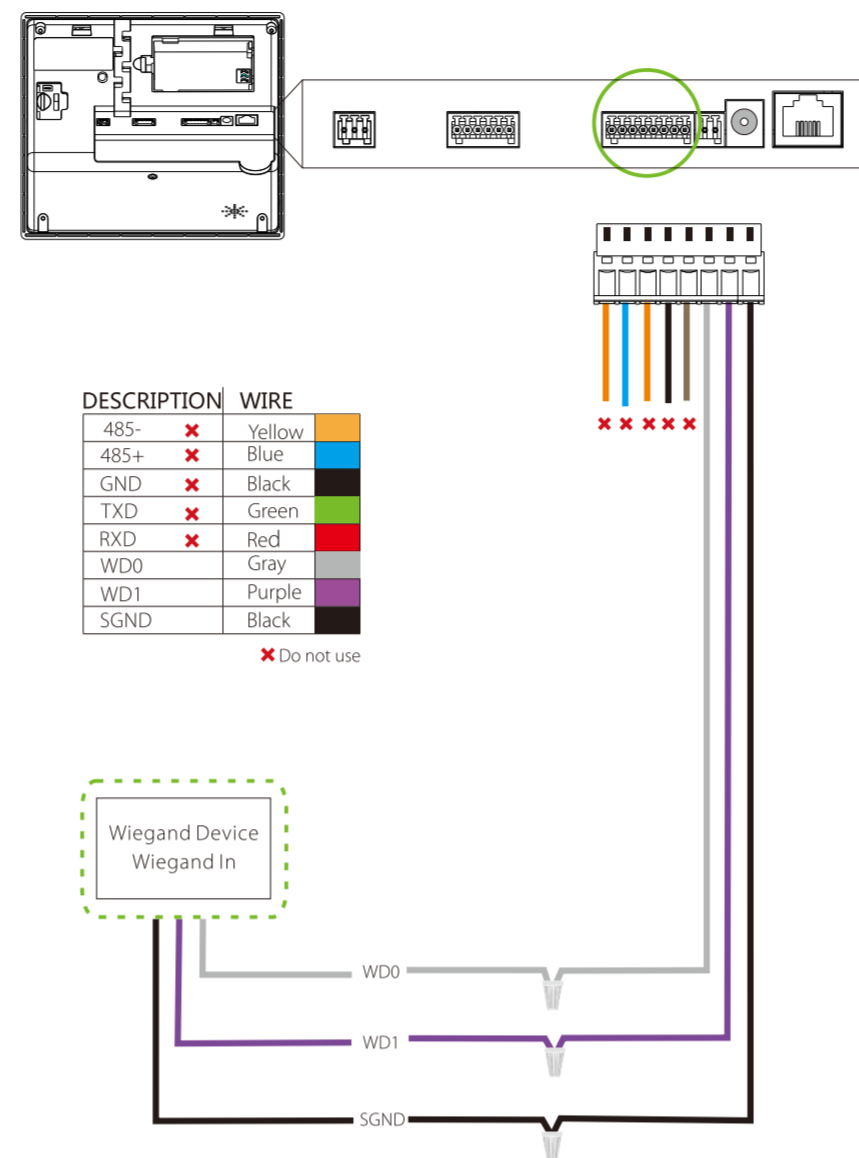

11

Power Connection

With UPS (Optional)

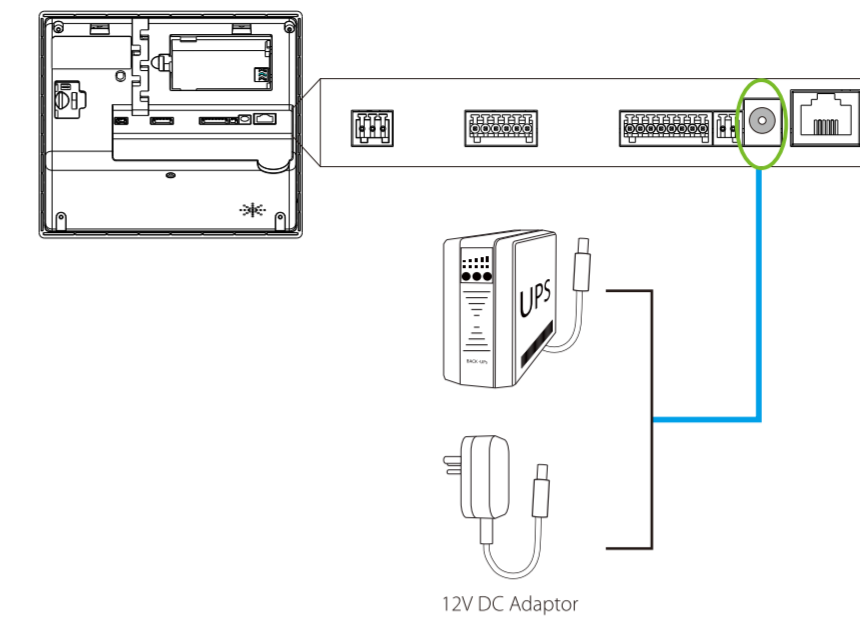

Without UPS

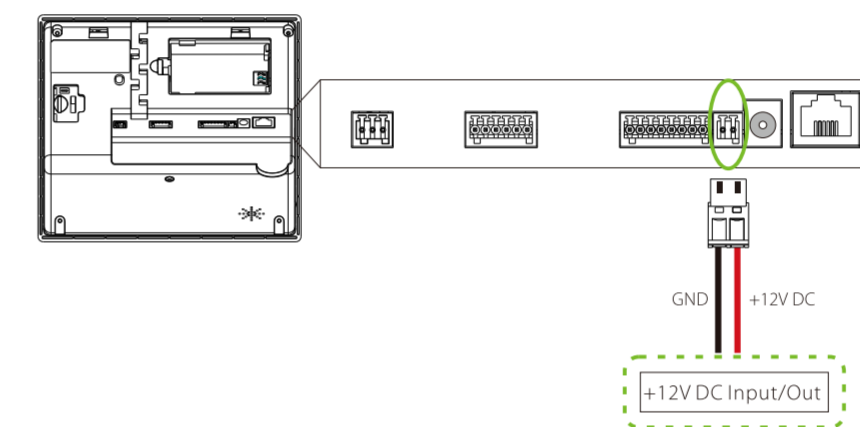

12

Standalone Installation

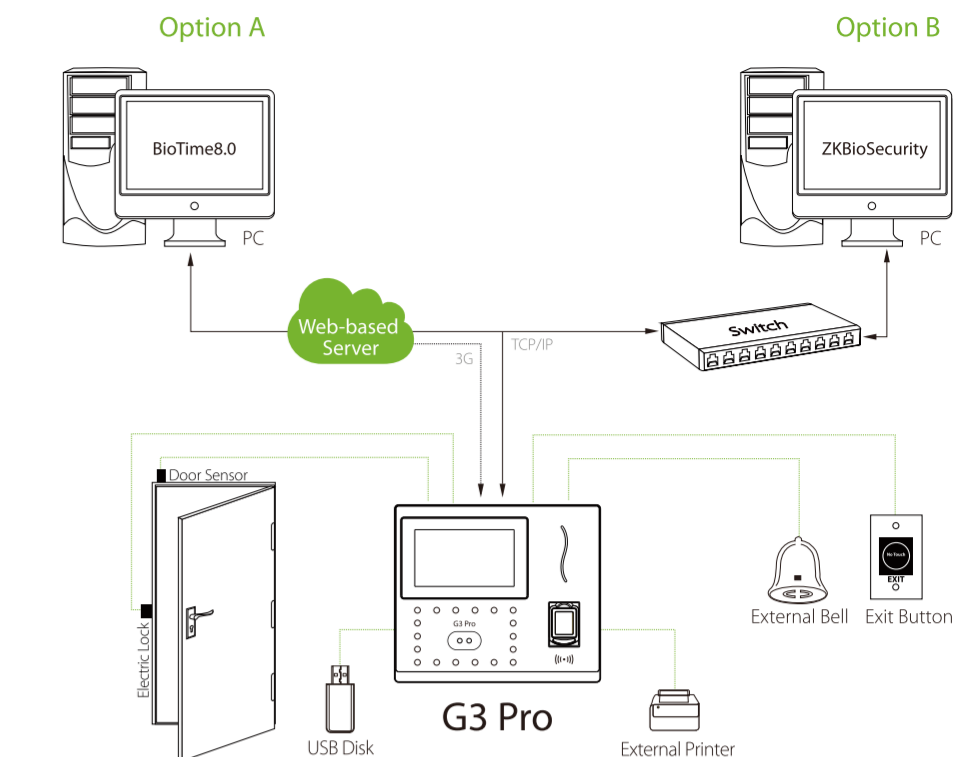

13

Device Operation

Quick flows

1) Administrator and User Enrollment
a. Administrator Enrollment
Main Menu > User Management > New User

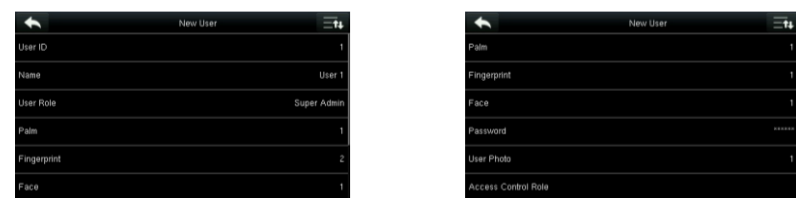

User ID: Enroll user ID; it supports 1-9 digits of numbers.
Use Role: Select the user role between Normal User and Super Admin.
Palm: Enroll palm according to the prompts of screen and voice.
Fingerprint: Enroll one or more fingerprint.
Face: Enroll face according to the prompts of screen and voice.
Badge Number: Enroll a badge by swiping the badge.
Password: Enroll the password; it supports 1-9 digits of numbers.
User Photo: Enroll the user photo which will be displayed after verification.
Access Control Role: Set the Access Control parameters of the user.

Access Control Setting (Main Menu>Access Control):



Access Control Options: Including Door Lock Delay, Door Sensor Delay, Door Sensor Type, NC / NO Time Period etc.
Time Schedule: Schedule Doors' opening time, 50 time zones are available to define.
Holidays: Set special time zones for holidays.
Access Groups: Set to manage employees in groups.
Combined Verification: Set various groups into a combined access group to achieve multi-verification.
Duress Options: Set duress function options.

b. Ordinary User Enrollment
Please follow the steps described in 1a above except the "User Role" option.

14

Device Operation

2) Communication Settings (Main Menu>Communication)



Ethernet: The device can communicate with PC via the Ethernet parameters.
Serial Comm: The device can communicate with PC via the serial port according to the user-defined parameters.
PC Connection: Set the password and device ID so that you can connect the device with software in PC.
Cellular Data Network: When the device is applied on a dial-up network, ensure that the device is within the coverage of the mobile network signals (3G).
Wi-Fi Setting: The device provides a Wi-Fi module, which can be built in the device mould or externally connected, to enable data transmission and to establish a wireless network environment.
Cloud Server Setting: Settings used for connecting with ADMS server.
Wiegand Setup: Set wiegand-out parameters.

3) Verification (1:1 verification mode for example)

Click [1:1] to enter 1:1 verification mode on initial interface.

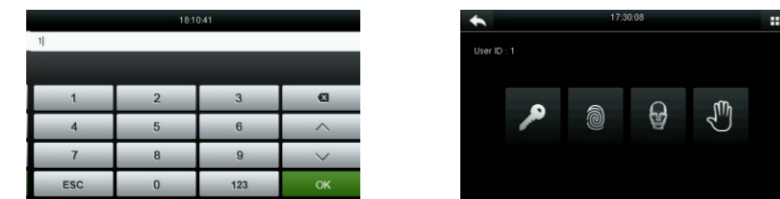

Enter User ID and press [OK].

If you have registered for multi-verification mode, please choose the verification method shown as above accordingly. The icons, from left to right, indicate password, fingerprint, face, and palm authentication.

a. Palm Verification Mode

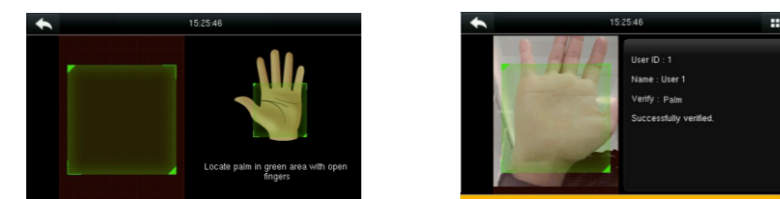

15

Device Operation

b. Facial Verification Mode



c. Fingerprint Verification Mode



d. Password Verification Mode

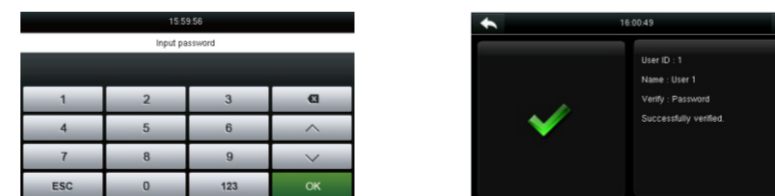

4) Viewing Attendance Records

a. View records in the device (Main Menu>Attendance Search>Attendance Records)

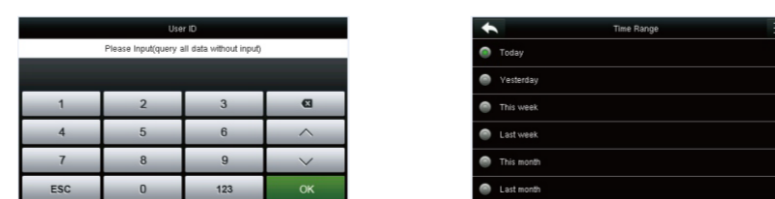

Enter the user ID to search.

Select the time range for attendance record query.

16

Device Operation



Tap the record in green to view its details.



The above figure shows the details of this record

b. View records on computer (Main Menu>USB Manager>Download>Attendance Data)

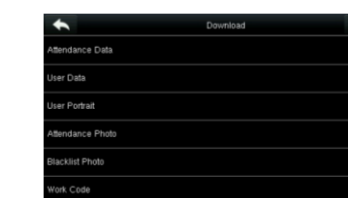

1. Insert the USB disk correctly.
2. Download the attendance data to the disk.
3. Upload the attendance data from the disk to your computer.
4. Name the downloaded data as "Device Serial Number.dat". You can open the downloaded data and view it.

Backup data

To avoid data loss due to mis-operation, you can back up the data to local drive or USB disk at any time.



1. Enter Main Menu>Data Management>Backup Data>Saving Type>Data Type to backup.
2. Select the content to-be-backed up.

17

Troubleshooting

Q: "Invalid time zone" is displayed after verification?
A: Contact Administrator to check if the user has the privilege to gain access within that time zone.
Q: Verification succeeds but the user cannot gain access?
A: 1. Check whether the user privilege is set correctly.
2. Check whether the lock wiring is correct.

If there is any problem when using the device, please visit www.zkteco.com and log on, and click [Support] --> [Trouble Ticket] to submit your question. Our technical team will provide you with technical support as soon as possible!

18