

USER MANUAL

Blade Series X-Ray Devices

Version: 1.0

Date: April 2019

Copyright

This manual covers usage and maintenance information of Blade series x-ray devices. Device owner or authorized person may have copy of this manual for only information purpose to use the device. It is strictly forbidden to reproduce and sell this manual for sale.

Manual Content

Content of this manual is arranged to cover all systems as of the date of printing. Any amendments and additions made after its date of print may not be included in the Manual. Please contact ZKTeco in order to obtain necessary information on such matters.

Operating Manual

Preparation: 06/04/2019.

Rev: 1

Prepared By: Harvey

Copyright©ZKTECO CO., LTD. All rights reserved.

Contents

1 Introduction	1
1.1 Windows Based Software New Features Properties.....	1
1.2 Security Properties	1
1.3 Films.....	2
1.4 Drugs and Foodstuff	2
1.5 Failure Identification.....	2
1.6 Display Properties	2
1.7 Automatic failure identification.....	2
1.8 Automatic Failure Control.....	3
1.9 User's Liability.....	3
1.10 Accessories.....	3
1.11 Health Standards.....	4
1.12 Safety of Use.....	5
2 Operating the X-Ray Device	6
2.1 System Control	6
2.2 Power Connection.....	6
2.3 Switching on the Device.....	8
2.4 Control Panel.....	8
3 Using the Device.....	10
3.1 User Login.....	10
3.2 Screening Mode.....	11
3.2.1 Luggage Scanning.....	13
3.2.2 Substance Groups.....	13
3.2.3 Control Console.....	14
3.2.3.1 Picture Analysis Buttons.....	14
3.2.3.2 Passed Luggage Examination.....	24
3.2.3.3 Programmable Function Keys.....	24
3.2.3.4 Magnifying Buttons.....	26
3.2.3.5 Warning Lights.....	27
3.2.3.6 Operational Buttons.....	28
3.2.4 Settings Menu.....	28
3.2.4.1 Settings Menu of Screen-operator and System-admin.....	29
3.2.4.2 Technician Settings Menu.....	33
3.3 Training Mode.....	37
3.4 Administration Mode	38
3.4.1 Account Management.....	38
3.4.2 Access Levels Management	39
3.4.3 Company Information.....	41
3.4.4 Training Setting.....	41
3.4.5 TIP Strategy	42
3.4.6 TIP Library.....	43

3.4.7 TIP Exam Query.....	43
3.4.8 Station Location Sub-menu.....	44
3.4.9 Sub-Site sub-menu.....	45
3.4.10 Startup Log.....	45
3.4.11 Session Log.....	46
3.4.12 X-ray Radiation Log.....	47
3.4.13 System Setting.....	47
3.4.14 Counter Setting.....	48
3.4.15 Hardware Setting.....	48
3.4.16 Register.....	49
3.4.17 System Information.....	49
4 Installation and Configuration.....	50
4.1 Power Supply.....	50
4.2 Environmental Conditions.....	50
4.3 Electric Power Cable.....	51
5 Periodic Maintenance.....	52
5.1 Periodical Weekly Maintenance.....	52
5.2 Quarterly Maintenance.....	52
5.3 Lead Curtains.....	52
5.4 Conveyor System.....	53
5.5 Radiation Leakage Measurement.....	53
6 Troubleshooting.....	54
6.1 Device does not start up.....	54
6.2 X-Ray Is Not Generated.....	54
6.3 Conveyor Motor Does Not Function.....	55
6.4 System Uninterruptable Power Supply (AC220 V, 50/60 Hz).....	55
7 Technical Specification, Blade6040.....	57
7.1 Physical Properties.....	57
7.2 X-Ray Generator & Image Performance.....	57
7.3 Computer Specifications.....	58
7.4 Operating Environment.....	58
7.5 Health and Safety.....	58
7.6 Standard Features.....	58
7.7 Optional Features.....	59

1 Introduction

This manual covers Blade series X-ray devices of ZKTeco brand.

Windows Based Software New Features Properties

ZK software is extremely stable and user-friendly. In addition, the software, along with its superior image processing, enables the realization of the real time image processing properties with programmable button synchronously without stopping the belt. The windows based x-ray device also comprises the hardware which ensures the operation of the system in it. The present manual describes the use of all software parameters accessed through the operator Console keyboard.

Security Properties

- The X-Ray open alarm lights are situated at the control console and at the four corners of the device and are on when the X-ray beam is active.
- Emergency stop buttons are placed at the tunnel entrance of device, at the entrance and exit ends, and on keyboard control panel. Limit switch which are placed at the bottom of two side doors will be activated when the side doors are opened for maintenance.
- Both Emergency stop buttons and Limit switch are used to cut the power of the system motor and x-ray generator. Once the power is cut the operator cannot move the belt or generate X-ray.
- The circuit breaker controls the power supply of the system.
- By means of lead-imbued plastic curtains located at the tunnel entry and exit, it is ensured that radiation leakage values remain within the required values by international regulations.
- There are metal covers at the entrance and exit ends that do not allow people to put their hands into the tunnel.
- The device's tunnel section and the X-ray generator are covered with a lead shielding.
- Electrical and radiation warning tags are displayed where needed on the system.



Do not insert hand, arm or any part of the body into the tunnel while x-ray beams are on.

Films

Devices of the Blade series do not harm film.

Drugs and Foodstuff

The radiation used at very low levels in the Blade series x-ray baggage scanning devices doesn't constitute any danger for any consumption of food stuff and drugs in terms of health.

Failure Identification

By means of its software properties, Blade series x-ray devices automatically control the electronic and computer-based functions of the system. The system, when confronted with any fault, indicates the location of the fault as a warning message on the screen. If the system has not been confronted with any failure during automatic control, the failure message will not show up and the system will be ready for use upon entry of the operator's fingerprint or identity and password.

Display Properties

Blade series x-ray baggage control devices display the contents of the luggage on the screen in a clear, color or black & white manner. The image content is controlled in detail through the image analysis function buttons on the control keyboard.

These buttons are as follows: High density, image inverting, black & white display, only inorganic, only organic, pseudo color, edge enhancement, best image, adjustable density, adjustable brightness, adjustable color and nine sectional enlargement.

Due to its multi-energy detectors, inorganic materials (metals) are viewed in blue color tones according to the density of the object, whereas organic materials (plastic, textiles, foodstuff) is viewed in orange color tones. The device indicates thickness exceeding penetration power in black color tones.

Substances with a complex internal structure, i.e. neither organic or inorganic objects (leather, glass, salts), are seen in the color green. In general, since all explosives feature an organic structure, they fall into organic substances group and are imaged in the orange color. Metals with low elemental density are displayed in the color blue. Substances to which X-ray device could not penetrate are displayed in black color.

Automatic failure identification

Blade security x-ray devices are fitted with hardware control features. Hardware control is automatically activated when the device is switched on.

Automatic Failure Control

All hardware is constantly under control when using the system. After the system is switched on, in case there is any fault, the fault message will appear on the screen. Otherwise the system is ready for use.

User's Liability

Operating Authorization

All users of x-ray devices, those using them in medical, airport security or industrial area, have to obtain the user's authorization from the regulating activities of their respective countries.

Accessories

There are additional hardware and software features which have been developed to ensure ease of use on Blade x-ray devices. Please call the service and the sales offices to get information on said accessories.

MACHINE TAGS

Following symbols are used in Blade devices where necessary.





	Attention symbol Consult the Manual whenever this symbol is encountered on the machine.
	Radiation symbol This symbol means the unit emits radiation.
 High voltage	High Voltage Symbol This symbol indicates dangerous high voltage.
	Grounding Symbol Indicates the point at which the system or other units will be grounded.

Figure 1: Machine Labels

Health Standards

The values shown in Figure 2 are values acknowledged by competent local authorities in many countries and other international authorities. These doses may be applied during 40 hours/week and 50 weeks/year.

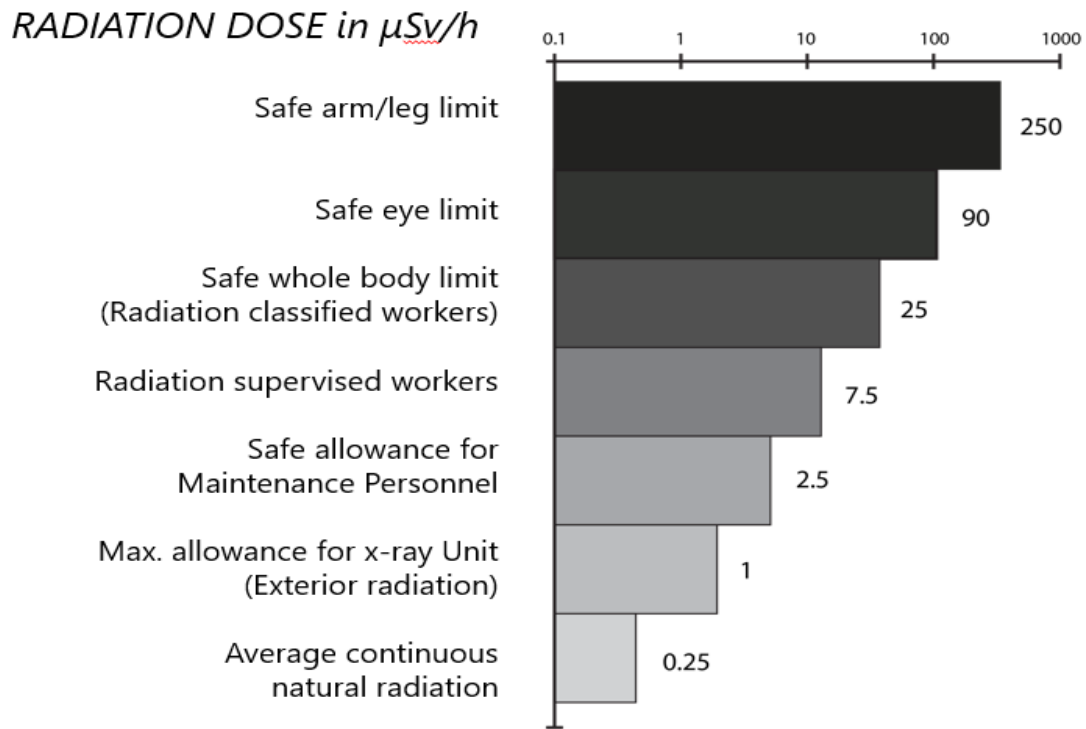

Figure 2: Maximum Allowed Applicable Dose $\mu\text{Sv/h}$ (mRem/h)



Attention

Strictly avoid inserting your arm or other organs of the body into the device tunnel.



Attention: Do not modify the device by any means.



Attention

Do not touch the device's electrical wires and connectors with bare hands or unprotected tools.

Safety of Use

The X-ray beams automatically turn on upon entry of the baggage into the tunnel and automatically turn off upon exit of the bag out of the tunnel, the system checks the calibration values until the baggage comes to the middle of the tunnel. When the device is initially switched on, the calibration process is always made automatically. The turning on and off of the X-ray beams is realized automatically, and while the x-ray beams are present inside the tunnel, the radiation leakage measured on the device's trunk is less than $1\mu\text{Sv/h}$.

NOTE: The value of radiography devices taking chest films is $300\ \mu\text{Sv/h}$ (30mRem/h).

This Blade series X-ray device is designed and produced to be used safely and efficiently. There is radiation generated by all x-ray devices and safety should be kept on the foreground while using the devices.

Attention

1. Before switching the device on, there should be no object on the conveyor's belt and inside the tunnel.
2. Strictly avoid inserting any hand and arm into the tunnel while the x-ray beams are on. The objects or goods inside the tunnel may be checked after the X-Ray beams are switched off.
3. Upon determining any dangerous threat items such as explosives, guns or knives inside the baggage checked, the Institution's security instructions should be followed.
4. Hands should be kept away from the conveyor edges.
5. Do not sit or lean on the conveyor.
6. The condition of warning labels and warning lights on the device should be checked and worn labels replaced.
7. There are high voltage and x-ray beam within the system, protective covers should not be opened in any way whatsoever during operation.
8. The maintenance functions of the device should be made by experienced technicians in accordance with x-ray scanning devices laws, and regulations.
9. Strictly avoid switching on the device while the lead curtains at the tunnel entry and exit are open or broken. Replace as necessary.
10. When any fluid is spilled over the conveyor, the system energy supply should be cut off and an authorized service technician should be called immediately.

2 Operating the X-Ray Device

System Control

Before switching on the device:

1. Check whether all covers of the device are closed.
2. Check the condition of the lead curtains.
3. Check whether cable sockets of the control keyboard are connected to machine's side.
4. Check that all emergency stop buttons are on and both side doors closed well.
5. Check whether there is any object inside the tunnel.

Power Connection

There is a label indicating the electrical values in the area where the electrical power sockets of all Blade devices are located, check whether the city network is in accordance with these values.



Attention: Power outlet must be grounded plug.

1. Set switching on main switch on the machine to 1.
2. Make sure supply and data cable of the monitor is plugged in.
3. From the service panel, check if main circuit breaker is on.
4. From the service panel, check if the UPS inside the device is open.
5. Check that the monitor power switch is on.
6. Check whether the device supply plug is connected.



Figure3: Main Switch and User Service Panel

Check if the cables of the control panel and the monitor are connected to the relevant cables coming from the device.



Figure 4: Monitor power and data sockets

Switching on the Device

Turn the switch on the control panel clockwise and wait.



Figure 5: ON/OFF Switch

After the system has been started up, the device will begin the calibration process. It is provided by automatically rotating the belt one round to check whether any object has been forgotten inside the device's tunnel during the calibration process.

Should there be no image on the screen despite the fact that the device is on, check the monitor's brightness, contrast settings and that the monitor wires are connected.

In the case of no energy light is on, check the network voltage and internal fuse of the device.

Control Panel

There are push-button keyboard, buttons for conveyor control, touchpad, emergency stop button and on/off-switch available on the Blade series control panel.

Besides, there is a fingerprint reader used to log in.



Figure 6: Control Panel

Picture analysis properties are controlled and access to system setting is provided through buttons on the keyboard.

Conveyor motor movement is controlled through Next, Back, Stop buttons.

On-Switch on the console turns the machine on and off. Should the emergency stop button be held down, the system will be set to stand-by.

Menu selection and user login processes can be conducted through the touchpad on the control panel.

When you wish to put the operating keyboard on the keyboard holder triangle key supplied with the machine should be used.

3 Using the Device

User Login

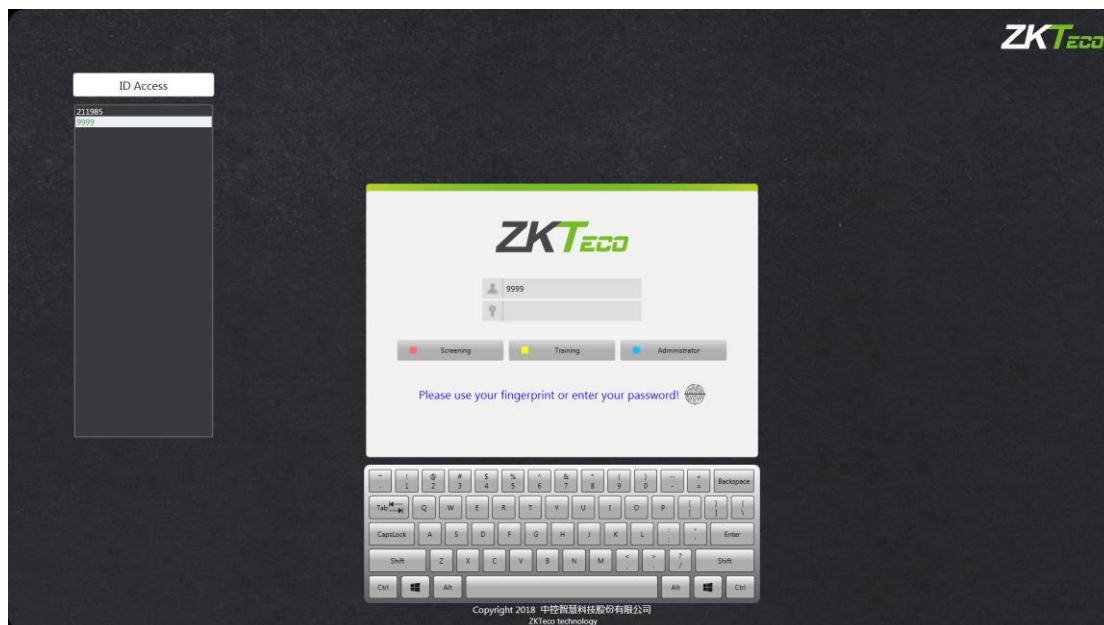

Figure 7: User Login Screen

Connect the power cord of Blade6040 to the mains, then reverse the key to “ON” in control keyboard, the user login screen is displayed. Place the registered finger on the fingerprint reader and enter the account.

Meanwhile, username and password can be used to log in too. One of the users identified on the left side of the screen must be selected via mouse. Password of the user must be entered to the password section through numeric buttons on the control console or virtual keyboard on the screen.

“Display”, one of the program modes available on the right side of identification and password section must be selected either through mouse or by pressing the control button in the relevant color as seen on the screen.



Attention

ID information and the password should be accurate. Otherwise login to the system will not be possible. Consult to your administrator in case you forget your username and password. The system default administrator account is “9999”, password is “123456”, Please enter the Account Management to change your password after the initial login to ensure your account information is safe.

Screening Mode

Entering ID and password and having selected the **"Screening"** mode, the screen below appears.

The device detects the important status such as detector, X-ray source, emergency, keyboard, UPS automatically.

Clear Tunnel

The belt will run a circle automatically to clear tunnel.

X-ray generator warming up

To ensure the X-ray generator can work in a good firm, there is a warming up process before entering screening mode.

Image Correction

To ensure scanned image in good quality, the image correction will appear after warming up process.

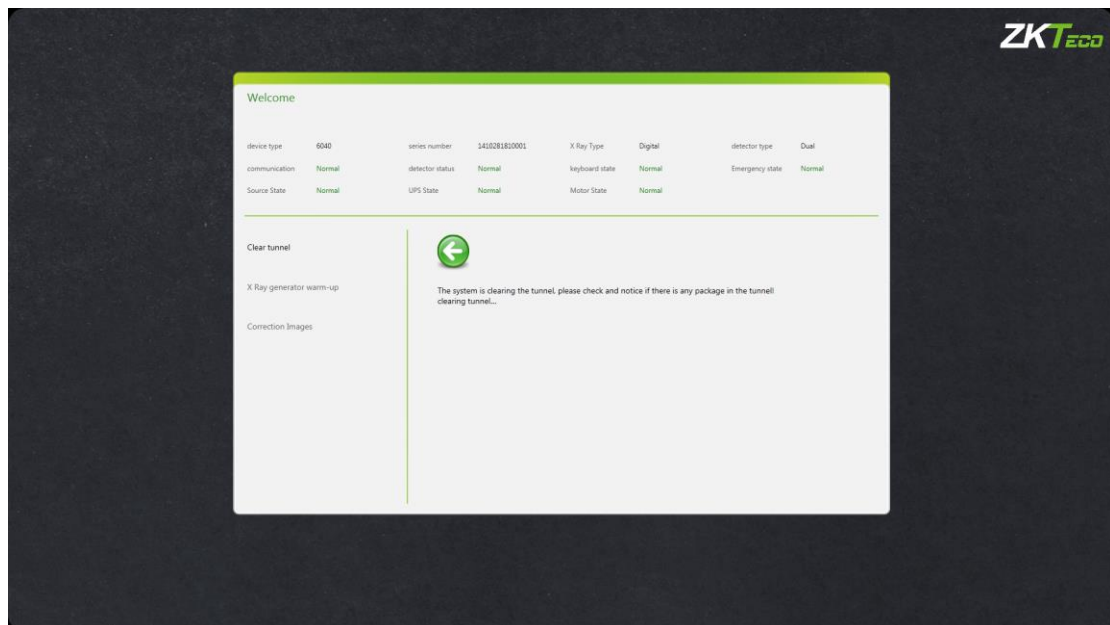

device type	6040	series number	1410281810001	X Ray Type	Digital	detector type	Dual
communication	Normal	detector status	Normal	keyboard state	Normal	Emergency state	Normal
Source State	Normal	UPS State	Normal	Motor State	Normal		

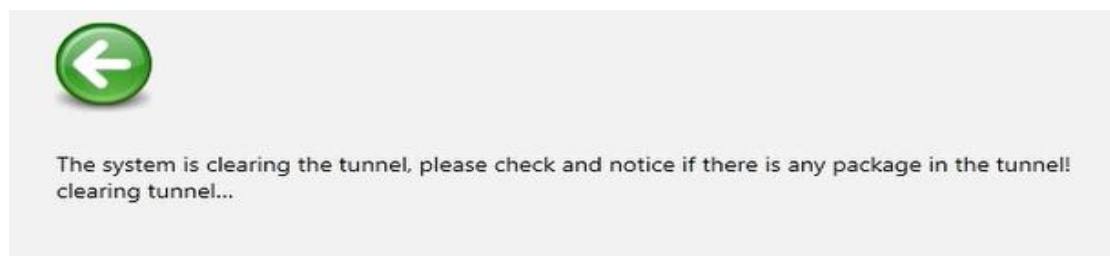



The generator needs warm-up, which can effectively improve the service life of the generator!
warm-up...



The image needs to be corrected, which can improve the image clarity!
image Correcting(ground data)...

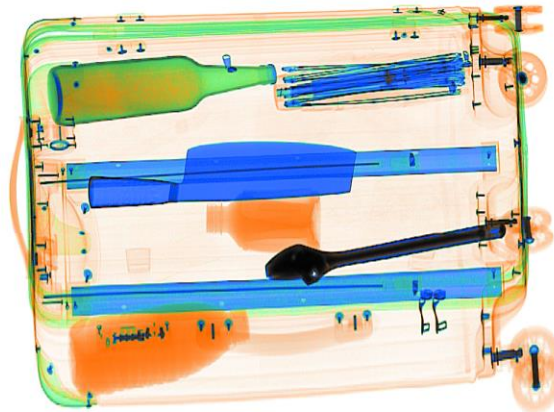

Figure 8: User Screen

User Screen:

- The screen properties of the screening mode are as follows:
- At the mid bottom part of the screen, the "ID" of the operator is indicated.
- At the mid bottom part of the screen, "Date", "Time" and "Baggage Counter" information is provided.
- At the left bottom part of the screen, there are three programmable button signs.
- Next to three programmable button is a "Message box" where warning sign stating x-ray is on (appears in yellow when it is activated)
- Warning for turning emergency states on and off are displayed in Message box.
- Conveyor "Next", "Back" and "Stop" function signs are displayed on the right bottom part of the screen.

3.2.1 Luggage Scanning

In order to perform a detailed image scanning, the luggage has to be placed horizontally onto the conveyor belt.

Next Button 

Upon pressing the Next button, the belt starts moving in a forward direction and the light surrounding the button is lit. At the same time, the sign indicating the belt turning direction on the monitor screen is lit as well.

Stop Button 

Upon pressing this button, the conveyor belt stops and the light surrounding the button is lit.

Back Button 

Upon pressing the Back button, the belt starts rotating reverse direction and the light surrounding the button is lit. At the same time, the sign indicating the belt turning direction on the operator screen is lit as well.

Attention NOTE: In order to enable reverse scanning, the bidirectional scanning property included in the device's software has to be activated.

Warning Light Stating X-Ray is on 

X-ray on light available on the control keyboard lights together with corner lights on the device during baggage scanning.

3.2.2 Substance Groups

Organic materials are a mixture of chemical elements whose atomic numbers are less than (10). This material group is displayed in the color orange on the screen. Important elements such as hydrogen, oxygen, carbon, nitrogen and nitrate fall into this group. Many explosives (such as Dynamites, Nitro-glycerine and Semtex) are made from mixtures of these elements. Drugs, paper, wood, water and plastics are also displayed in orange.

Elements of medium weight, (e.g. aluminium), are displayed in green on the screen. If organic and inorganic materials overlap, the picture is displayed in green on the screen. This group is called the mixed group.

The inorganic material group comprises metals such as zinc, tin, copper, iron, stainless, etc. These materials are displayed in blue on the screen.

When the thickness of these materials exceeds the penetration limit, it is displayed in black on the screen.

Monitor image of the objects scanned are displayed in "**Orange**", "**Green**", "**Blue**" tones and as constant "**Black**" according to the color, substance group and density such objects bear.



Figure 9: Substance Group Colors

3.2.3 Control Console

The following control keyboard is available for control consoles of ZK devices.



Figure 10: Control Panel with Push-Button Keyboard

3.2.3.1 Picture Analysis Buttons

Thanks to the system software, selected function keys may be activated together synchronously. Besides, picture analysis function can be used no matter the belt is moving or not.

NOTE: Refer to settings section in order to change the functional state of the buttons.

Upon pressing the buttons, the image changes on the screen are illustrated and explained in this section.

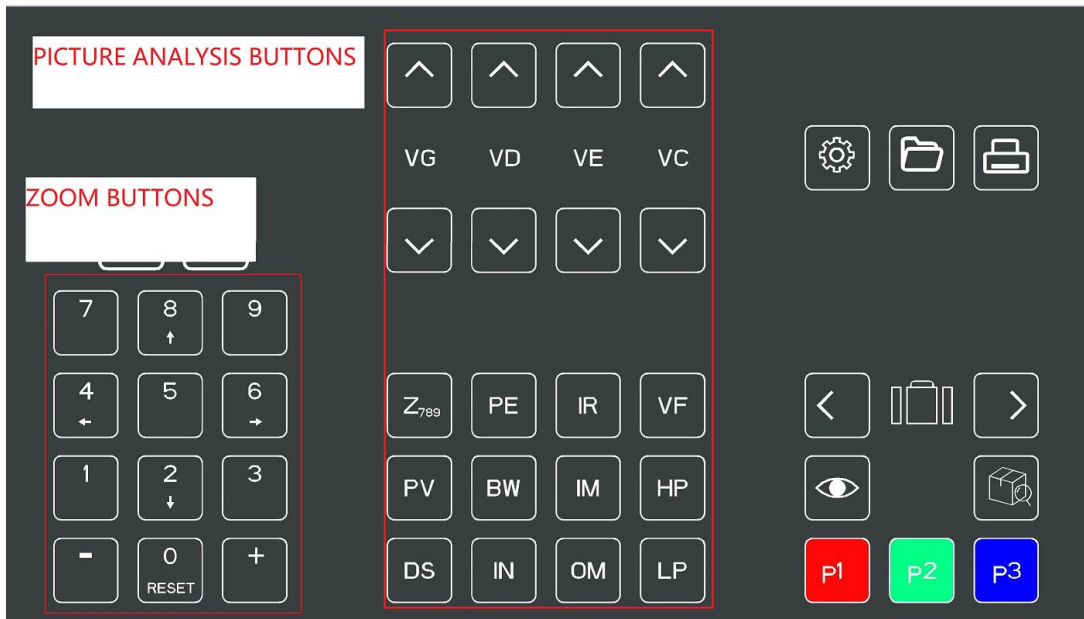









Figure 11: Push-Button Keyboard and Function Buttons

The explanation of the function keys is given briefly in the following table, whereas detailed descriptions and modifications of the image are illustrated and explained on the forthcoming pages.

PUSH-BUTTON KEYBOARD	EXPLANATION
 VG 	Variable Gamma
 VD 	Variable Density
 VE 	Variable Edging
 VC 	Variable Color









	Variable Organic Display
	Peripheral Enhancement
	Auto-Mark
	Vertical Flip

Figure 12: Keyboard Analysis Buttons-1

PUSH-BUTTON KEYBOARD	EXPLANATION
	Perfect View
	Dynamic Scan
	Black & White
	Inversing
	Inorganic Material

<div data-bbox="507 219 603 320" style="border: 1px solid black; padding: 5px; text-align: center;">OM</div>	Organic Material
<div data-bbox="507 371 603 472" style="border: 1px solid black; padding: 5px; text-align: center;">HP</div>	High Penetration
<div data-bbox="507 524 603 624" style="border: 1px solid black; padding: 5px; text-align: center;">LP</div>	Low Penetration

Figure 13: Keyboard Analysis Buttons-2

PV (Perfect View)

This function would show the both of easy-penetrate items at the same time. Even if the item hides between two metal boards, it still could be showed clearly.

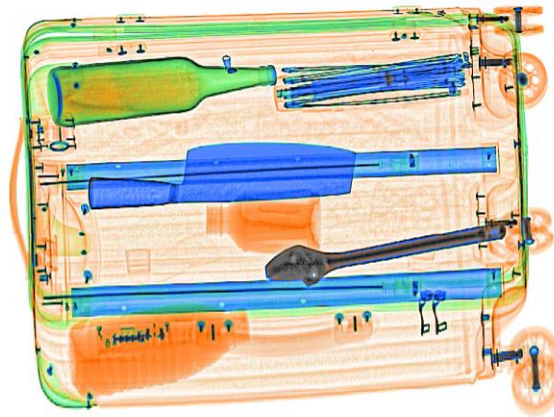

Figure 14: Perfect View Image

DS (Dynamic Scan)

Image would display dynamically with this function.

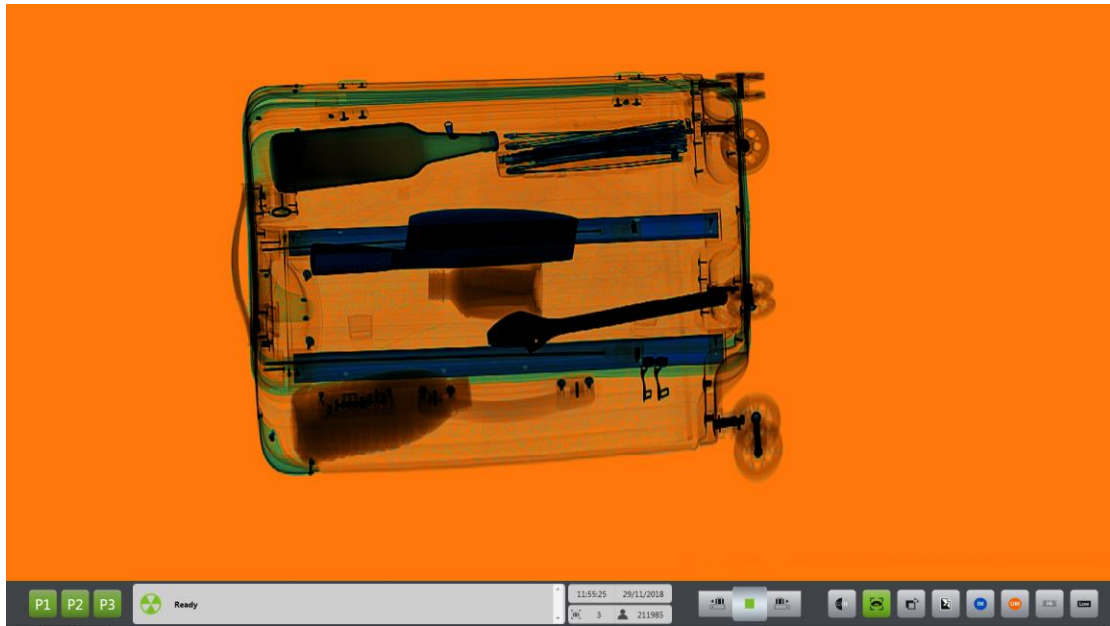

Figure15: Dynamic Scan Image

BW (Black & White)

Upon pressing this button, the color view on the screen is displayed as black and white.

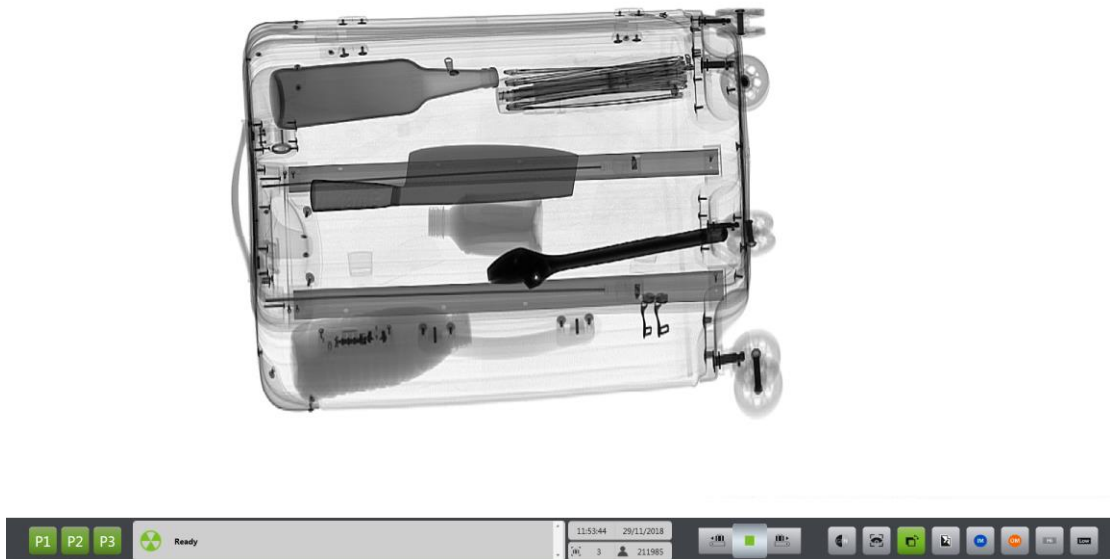

Figure16: Black & White Image

IN (Inversing Button)

Upon pressing this button, the image is inverted. The white colors are displayed in black, the black colors are inverted into white.

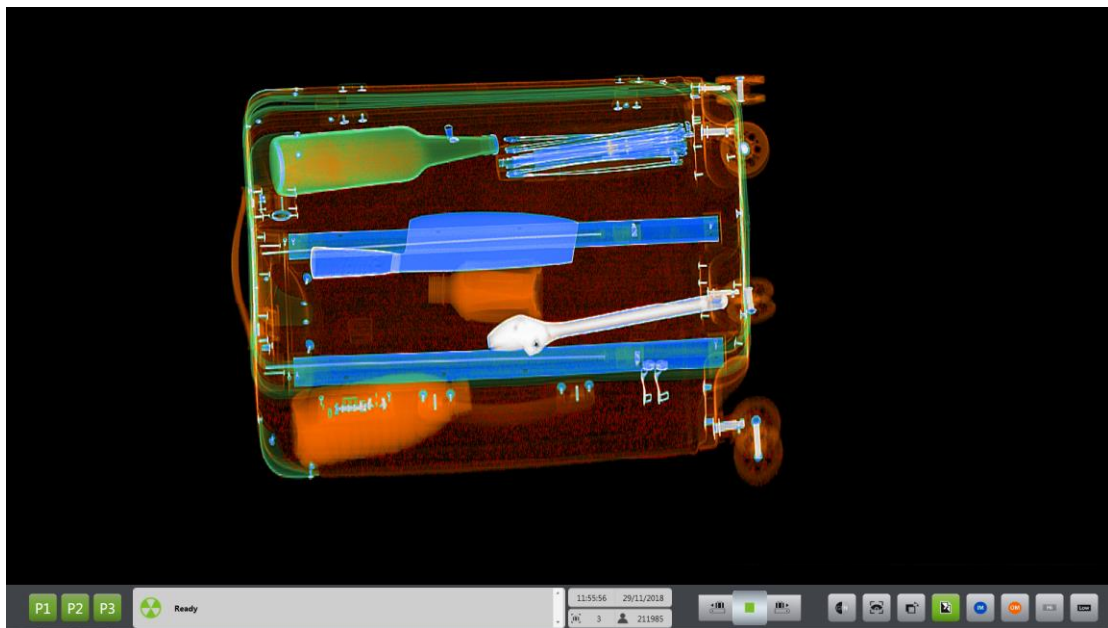

Figure17: Inversing Image

OM (Organic Material)

Organic material would show as B&W. Upon pressing the button "OM", only metal materials are displayed in blue, whereas the other group colors are displayed in black and white.

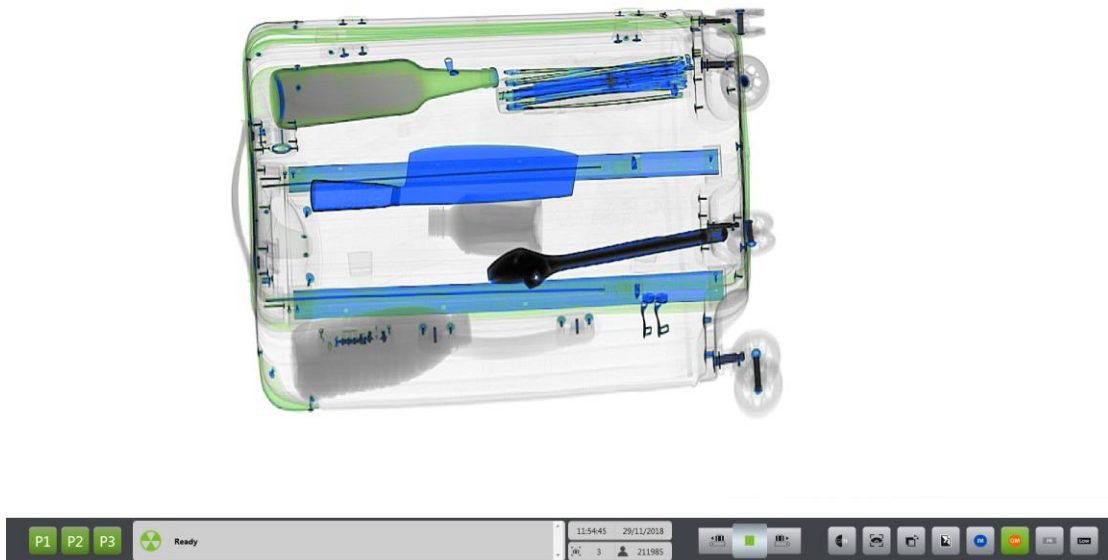

Figure18: Organic Material Image

IM (Inorganic Material)

Inorganic material would show as black and white. Upon pressing the button “IM”, only organic materials are displayed in orange, whereas the other group colors are displayed in black and white.

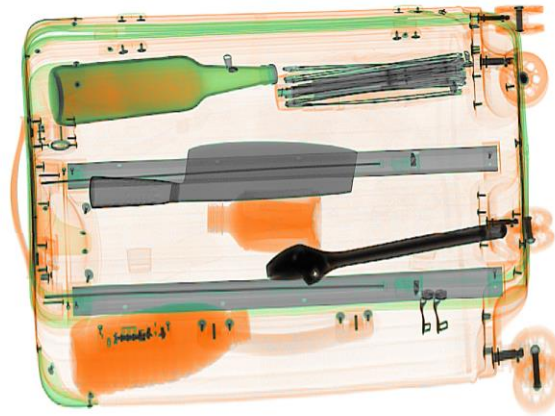

Figure19: Inorganic Material Image

HP (High Penetration)

Upon pressing this button, the high density materials in the image are brought to the foreground and the densities in the view are clarified.

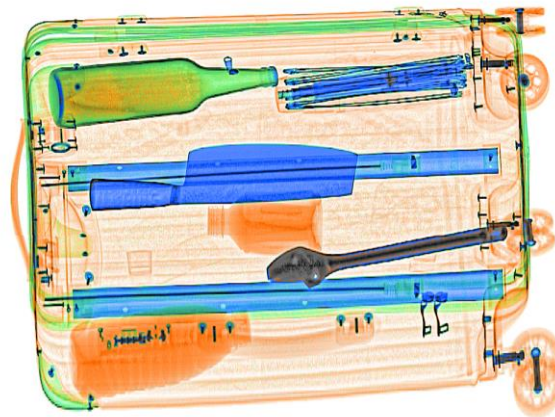

Figure 20: High Penetration Image

LP (Low Penetrate)

Improve the contrast of light area.

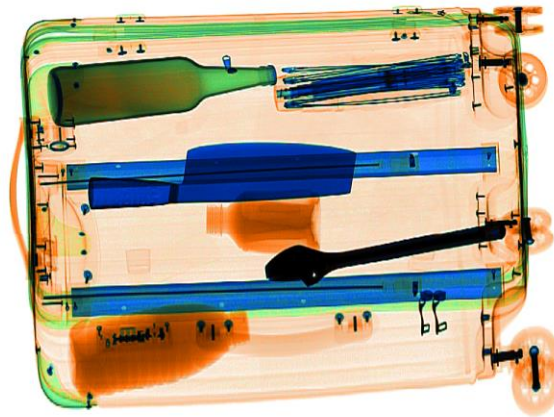

Figure 21: Low Penetrate Image

VG (Variable Gamma)

Variable gamma enables the operator to change the image brightness by using the buttons "G-" and "G+".

Upon pressing the "G-" button consecutively, the picture brightness is decreased gradually.

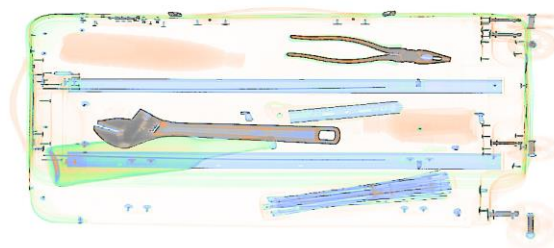

Figure22: Variable Gamma Reduced Image

Upon pressing the "G+" button consecutively, the picture brightness is gradually increased.

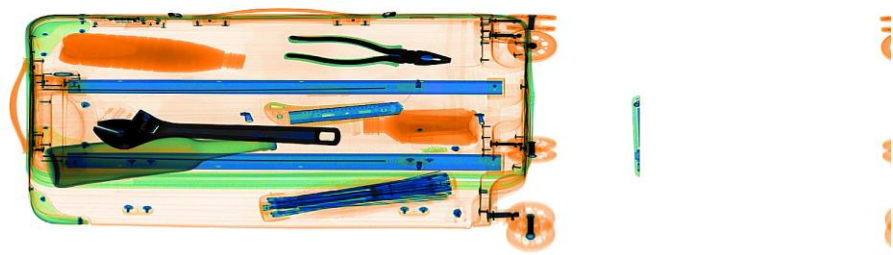

Figure23: Variable Gamma Increased Image

VD (Variable Density)

Variable density increases or decreases the densities of the materials included within the image by using the buttons "D+" and "D-".

Upon pressing the button "D-" consecutively, the density is decreased gradually.

Whereas upon pressing the button "D+" consecutively, the density is gradually increased.

VE (Variable Edging)

The alterable edge extension function emphasizes the edge lines of the picture through the pixels forming the picture.

Upon pressing the "E-" button consecutively, the picture's edge distinction is decreased.

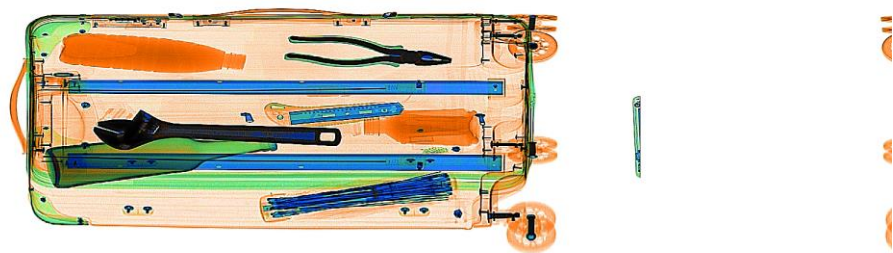

Figure 24: Variable Edging Reduced Image

Upon pressing the “E+” button consecutively, the picture’s edge distinction is increased.

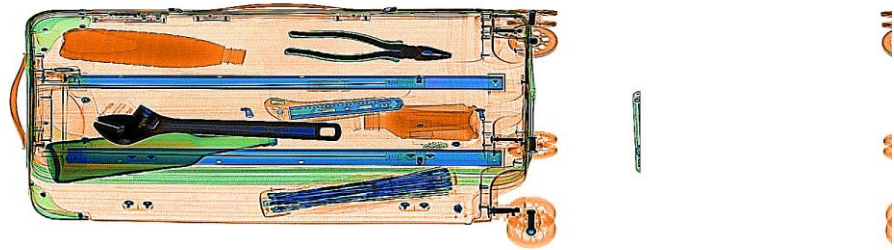

Figure25: Variable Edging Increased Image

VC (Variable Color)

By using the button “C+” and “C-”, the material groups are displayed in different color mode.

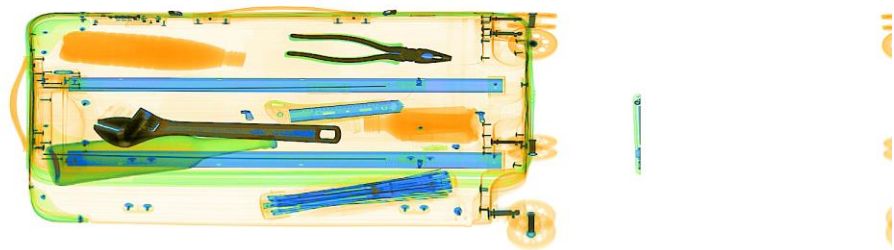

Figure26: Variable Color Toning Group1

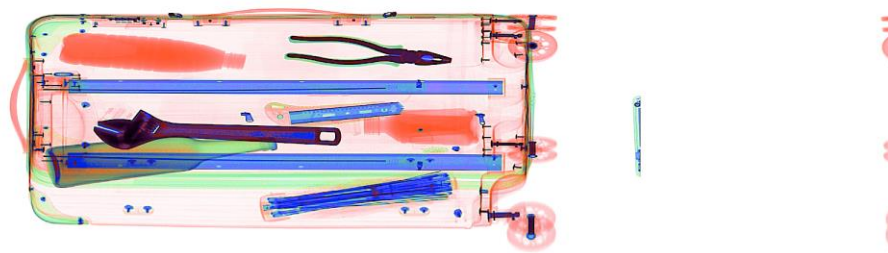

Figure27: Variable Color Toning Group2

3.2.3.2 Passed Luggage Examination

This is used to call any scanned luggage back to the screen and examine it. The operator may use these buttons (in forward or reverse direction) and perform image examination.



Figure28: Passed Image Recall Keys

Previous Baggage



Button is pressed and previous images are called in turn.

Next Luggage



Button is pressed consecutively and goes until the last image.

Upon pressing this button, previous images are called. This process can be performed up to the last image saved in the memory. When the last image is recalled, the message. In order to escape this mode, simply press the Motor movement key.

3.2.3.3 Programmable Function Keys

The device software enables the user to use many picture analysis functions together. Thus, operators are able to make the best combination for themselves and use the system in a fast way.

The system program enables the senior administrator to adapt three programmable function buttons as she/he wishes.



Figure29: Programmable Function Buttons on the Keyboard

NOTE: See “Setting” section in order to program the buttons.



ATTENTION

This programming process might be restricted for the operator. Consult with your administrator to configure.

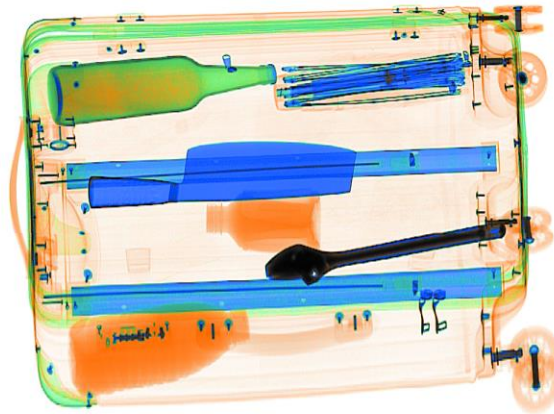

Figure30: Normal Image

For instance, “PE” and “BW” properties can be activated by a single button.

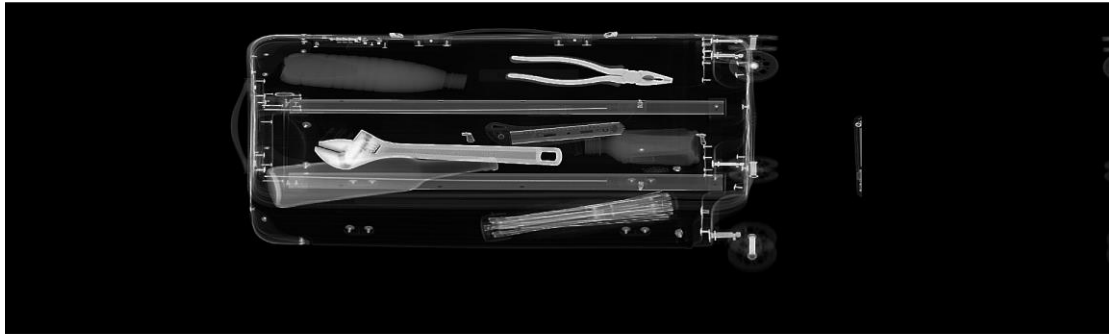

Figure31: Image with Function Key Used

3.2.3.4 Magnifying Buttons

Real time magnifying between "2X" and "128X" can be performed on the image available on the screen.

In the following figure, the image displayed as a specimen illustration is divided into 9 parts. The digits on the device's control keyboard denote the relevant button of each section. Upon pressing the numbered buttons, the relevant section of the image would be magnified.

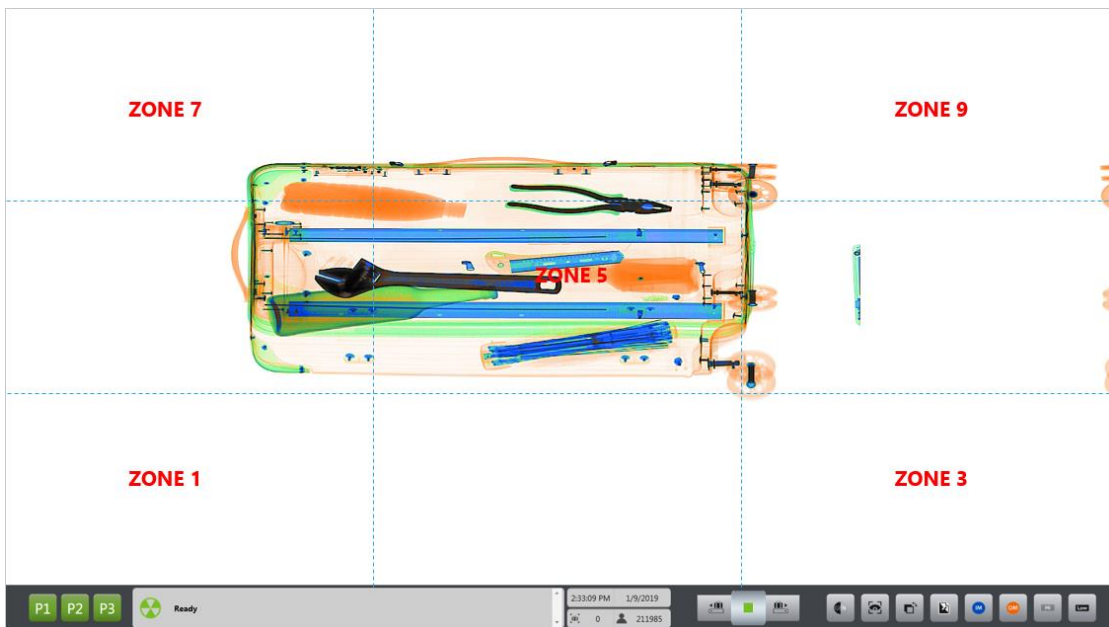

Figure32: Magnifying Sections

For example, if it is requested to magnify the bottom-left corner of the image on the screen, the button "1" has to be pressed over the control keyboard. Whereas, if it is required to magnify the middle part, the button "5" has to be pressed.

Upon pressing the button "5", the relevant part of the image on the screen is displayed on screen 4 times greater than its size.

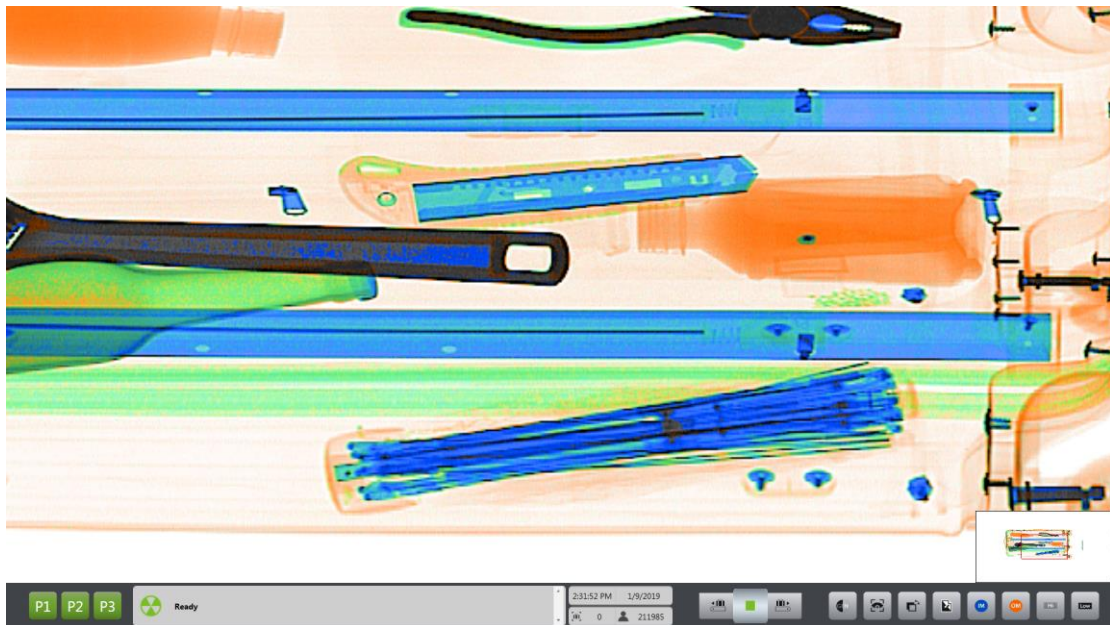

Figure33: 4X Magnifying 5 Parts

The image that can be zoomed 4 times can be even enlarged by pressing “(+)”button. By pressing “(-)”button, zooming coefficient is reduced. By pressing “(+)”button, zooming is possible up to 64 x.

In order to return to the normal screen from the magnified image or processing functions, the button “0”situated under the sectional magnifying buttons on the control keyboard has to be pressed.

3.2.3.5 Warning Lights

X-Ray Warning Light

There is an x-ray warning light on the control keyboard. This lights up during the x-ray generation.



Figure34: X-Ray Warning Light

In the event that x-ray warning light is continuously ON after the baggage scanning is finished, inform the Technical Service for this matter.

Network General Alarm Warning Light (Optional)

Should ZK devices operate under an Optional Blade Network Program and when an alarm is given by a device within the network, network administrator warns all the operators with this warning light.



Figure35: Network General Alarm Warning Light

3.2.3.6 Operational Buttons

Operator is able to carry out operational functions such as signalling the second operator, easy access to archive, printing-out archive image through a printer (optional) connected to the device.

Print-out Archive Image Button (Push-Button Keyboard Optional)

Operator can print-out the archive images on the page by pressing this button. This process is optional and consult your administrator to see if it is available.



Figure36: Push-Button Keyboard Printer Button

Button for Opening Archive Images

Operator can view archive with this button. Your administrator must grant archive monitoring authorization to your operator for this process. Consult with your Administrator for menu activation.



Figure37: Button for Opening Archive Images

3.2.4 Settings Menu



Upon pressing the settings  button through the control keyboard while the system is operating in the screening mode, the settings menu will appear. Access to the device setting is enabled by entering the settings menu as the system-operator, system-admin or screen-supervisor. Screen-operator, system-admin have same access in Setting sub-menu while screen-supervisor has higher.

3.2.4.1 Settings Menu of Screen-operator and System-admin

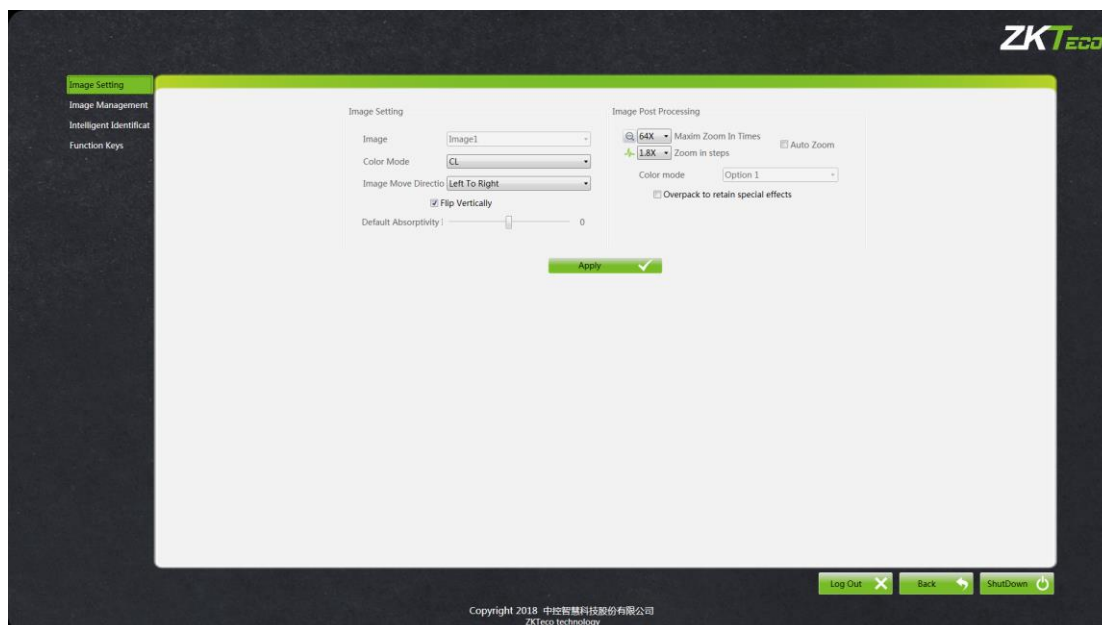

Figure38: Settings Menu of Screen-operator and System-admin

Screener settings menu is as follows:

Apply should be used to save configuration after any setting change.

Log Out should be used to log out from current account.

Back could be used to go back screening menu.

3.2.4.1.1 Image Setting

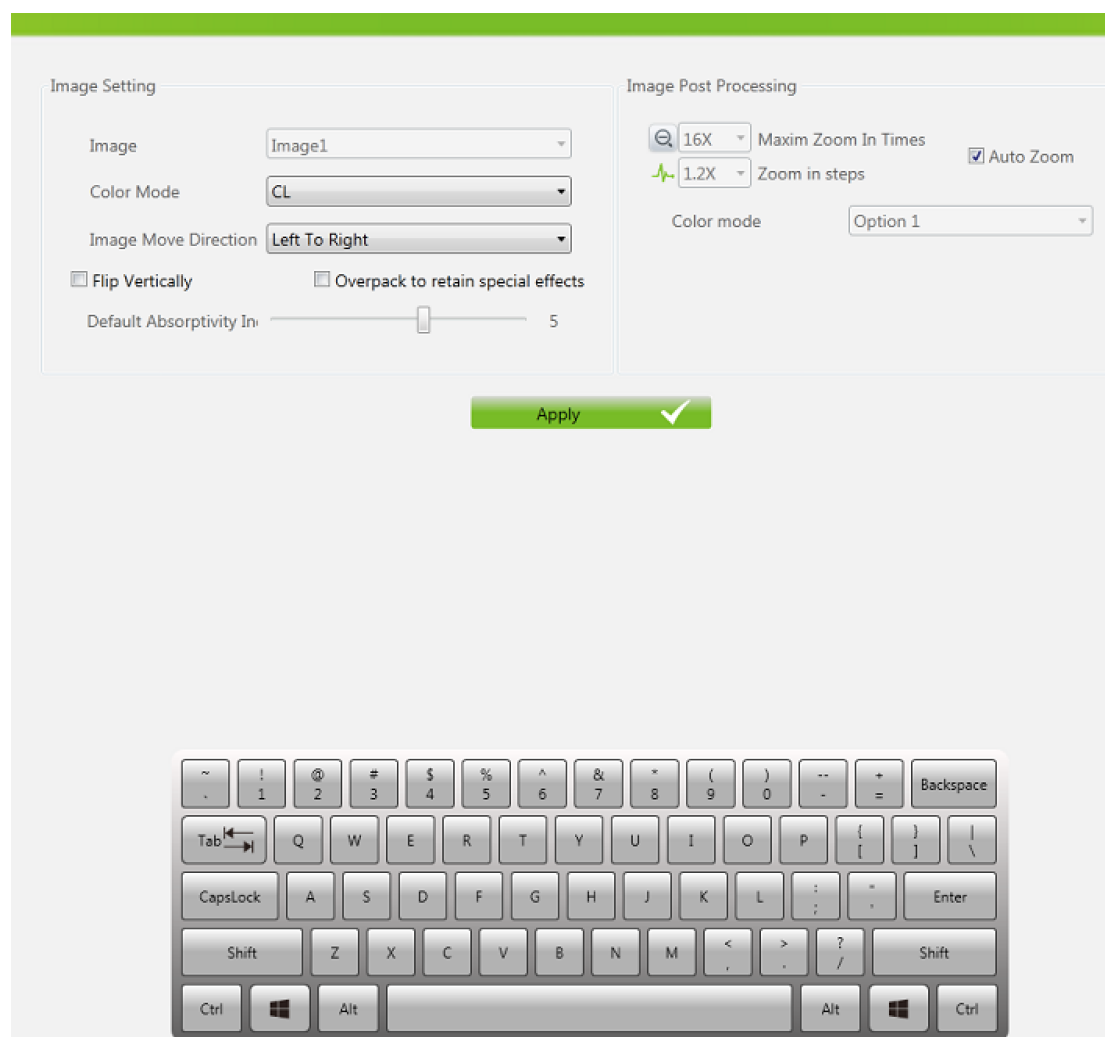

Figure39: Image Setting Menu

- 1) **Image:** The image includes image 1 and image 2 (for double-screen display). You can set configuration of both images separately which displayed on different screens. If the equipment is single-screen display, you can only select image 1.
- 2) **Color Mode: Color Mode** refers to the display color mode designated during scanning. Including:

(i) Black & White image	(v) Organic material
(ii) Color image	(vi) Suspicious organics enhancing Z7
(iii) Pseudo-color 1	(vii) Suspicious organics enhancing Z8
(iv) Inorganic material	(viii) Suspicious organics enhancing Z9

For their image effects, refer to **3.2.3.1 Picture Analysis Buttons**.

- 3) **Image move direction:** The scanned parcel image can be displayed from left to right or from right to left.
- 4) **Flip Vertically:** Flip vertically of parcel images scanned in main interface.

- 5) **Retain Image Post Processing:** When this function is unactivated, all selected image post processing will work once. Active this function, all selected image post processing will work in real-time mode.
- 6) **Default absorptivity index:** Absorptivity can be used to show the details of objects in different materials and thickness in the image. Variable absorptivity still keeps certain contrast beyond absorptivity range. This function can brighten/blacken the whole image (equal to the fine tuning of high/low penetration). The lower the absorptivity level, the brighter the image will be, so the decrease effect will be in the opposite way. Levels of the system setting are 50, i.e., -25~+25. Brightening corresponds to the "absorptivity-" and decrease corresponds to the "absorptivity+" on the keyboard.

Image Post Processing Sub-menu

Maxim Zoom In times: Maxim Zoom In times can be set from 4 times to 128 times.

Zoom In times Per Step: Zoom in times pressing once zoom in key in control keyboard, can be set from 1.2 to 2.0 times.

3.2.4.1.2 Image Management

Image Preview

All images which generated after scanning (originally scanned image) will be automatically saved in the hard drive of the scanning equipment. Single click image list on left side, a thumbnail image would show on right side.

The preview interface will display the latest 16 parcel images. And the storage order of image files will rank by chronological order of checking image.

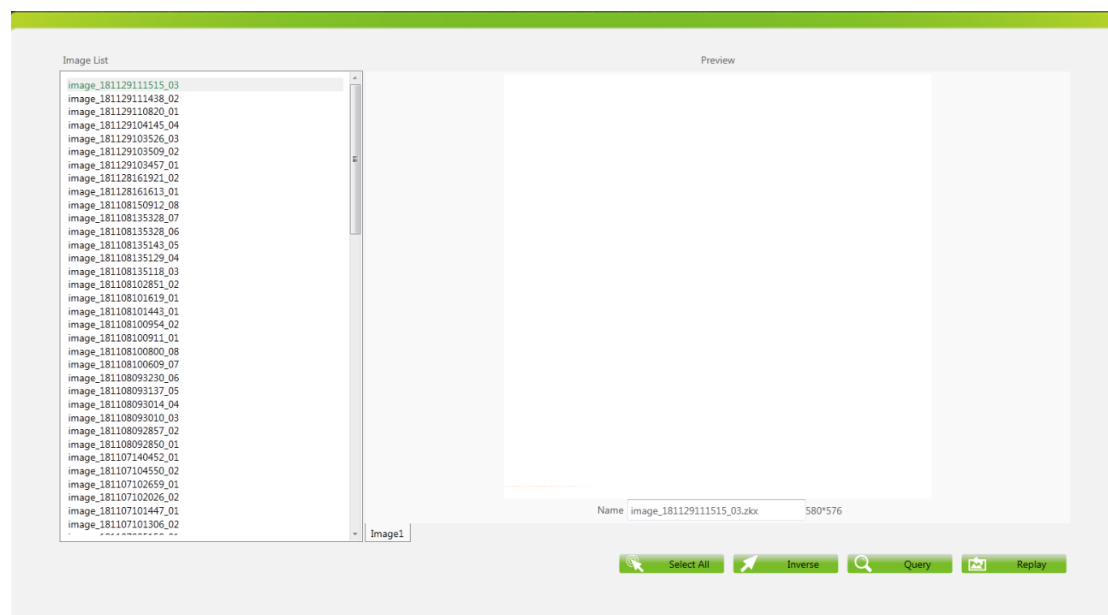

Figure40: Image Management

(Example: The naming rules of baggage image: image + baggage scanning time + serial No., for example, image_181129111515_03)

- 1) **Query:** During image inspection process, you can check former images through image

enquiry.

- 2) **Relay:** Select replay function and the selected images will be displayed on the main interface.
- 3) **Select all:** Select all of the images in left side image list.
- 4) **Inverse:** Select all of the images in left side image list apart from single clicked images.

3.2.4.1.3 Intelligent Identification

High Density Alert and Drugs and Explosives Inspection

Enable should be used to activate the function, **Alarm Buzzer** should be used to activate Buzzer. **Sensitivity** can be set from 1 to 5(5 is the highest sensitivity).

When **High Density Alert** is activated, there will be a red frame to mark high density thing during scanning. When **Drugs and Explosives Inspection** is activated, there will be a pink frame to mark related suspicious thing during scanning.

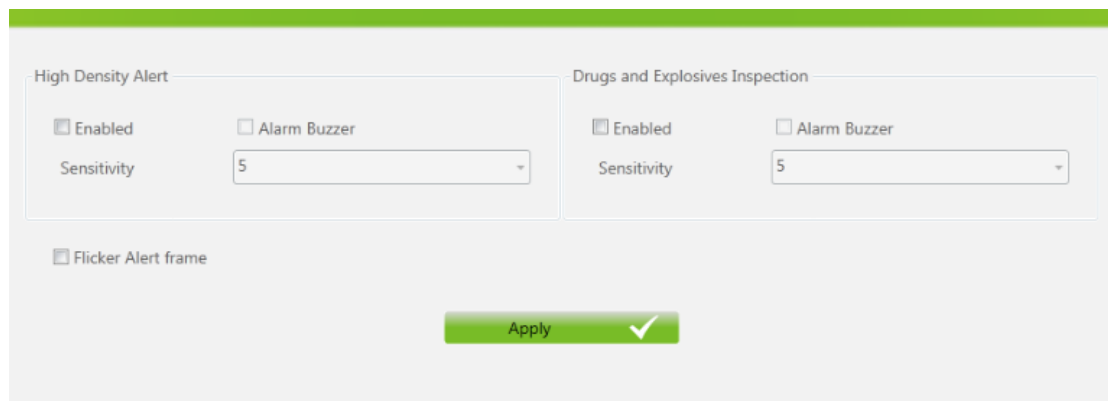

Figure41: Intelligent Identification

3.2.4.1.4 Functional Keys

Use **Functional Keys** to define three programmable keys at the left bottom part of the screen. To select corresponding combined image processing function in the combined processing pull-down list based on specific needs.

Shortcut keys options

Color + perfect view	Black & White + perfect view
Color + inversing	Black & White + inversing
Color + high penetration	Black & White + high penetration
Color + low penetration	Black & White + low penetration
Switch between Black & White and color	Restore

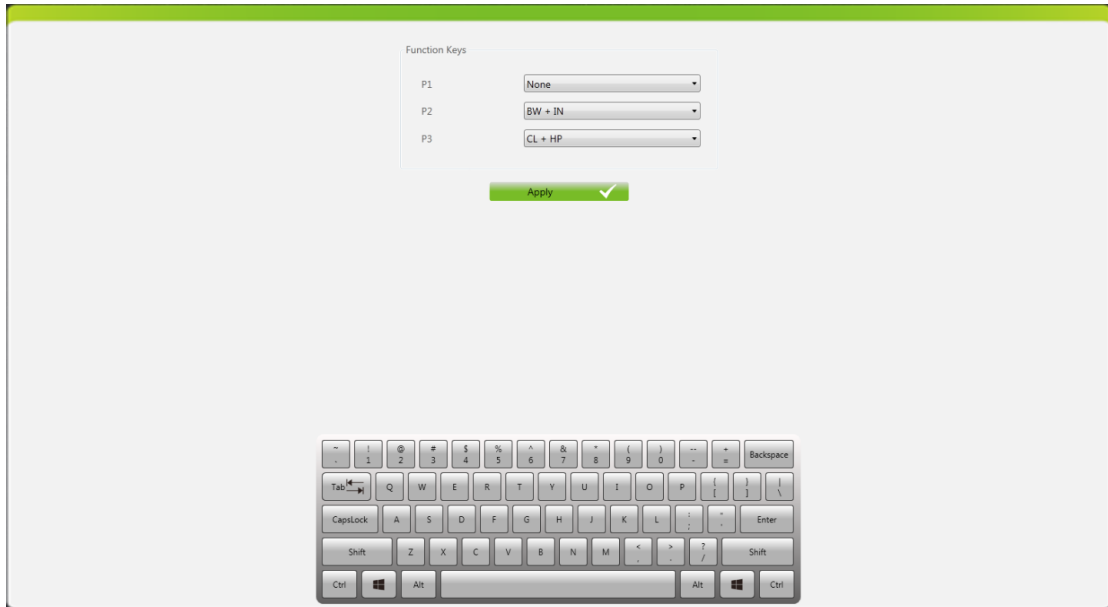

Figure42: Functional Keys

3.2.4.2 Technician Settings Menu

Different from the system-admin, screen-supervisor has access to the **Device maintenance** setting sub-menus.

Menus mentioned below may be restricted by the system-technician. Consult device provider should there be no active menu or sub-menu as defined in the manual available. Technician settings menu is as follows.

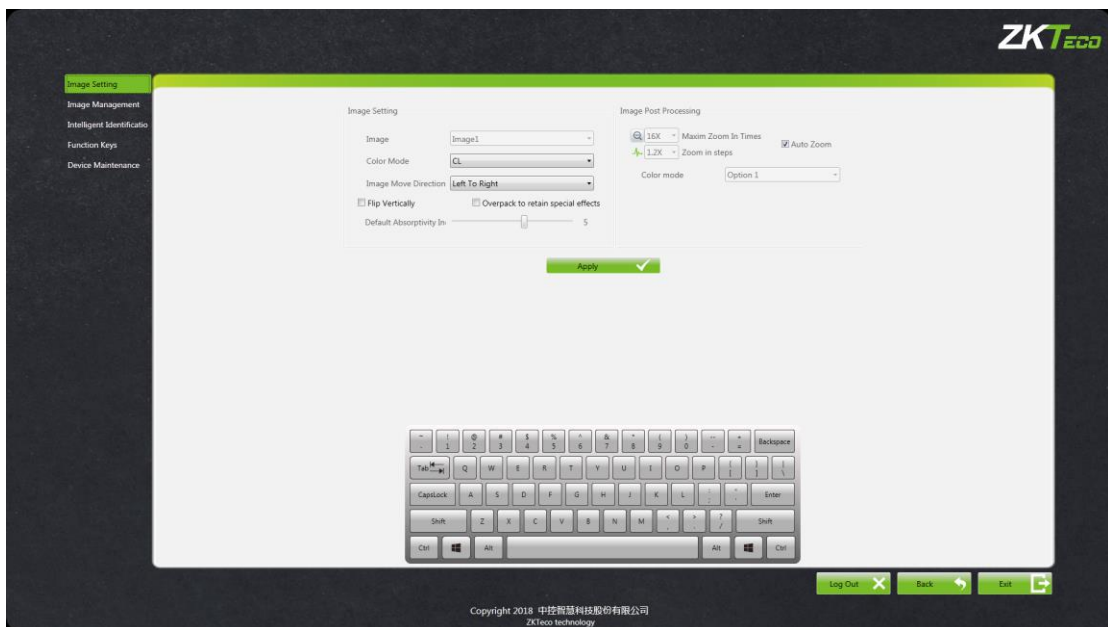

Figure43: Administrator Settings Menu

Device Maintenance

System has two user groups, which are administrator and operator. Administrator and operator have different authorities, operator only could change image setting and modify password of

current user and administrator could modify all settings except “**Device Maintenance**”.

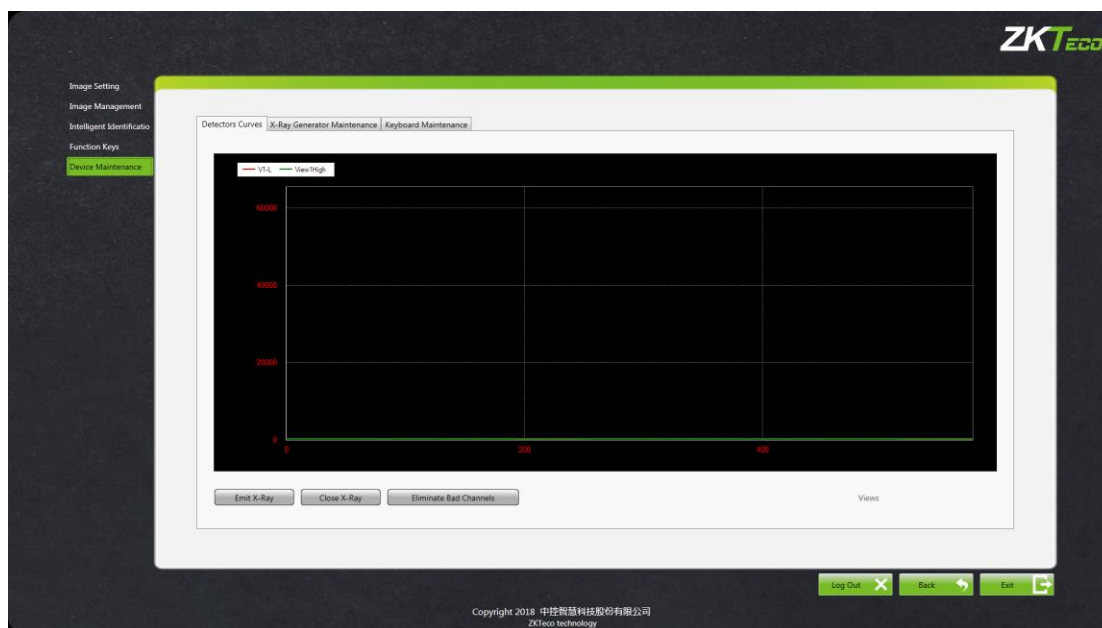

Figure44: Device Maintenance

1) Diode Diagram:

When Diode Diagram. Sub menu is entered, it is possible to see diode cards string according to X-ray radiation position and to make necessary adjustments and controls. Before adjustments are carried out, X-ray radiation measures (condition of lead curtains) must be checked and the x-ray must be activated using **Emit X-Ray**. Before doing any physical modification, **Close X-ray** and Emergency button must be used in case X-ray hurt people’s health.

Graphic changes when the positions of x-ray generator or collimator are changed. Best graphic means that red and green points are as linear as possible. Graphic formed by red points symbolize graphic low energy points and green points symbolize graphic high energy detectors’ data line.

Upon entering Eliminate Bad Channels sub menu, the device allows for photo diode skipping. Diode erasing is restricted in the XRC series and diodes may be erased up to a certain number. In such a case, once the maximum number has been reached, photo diode cards must be exchanged with new one.

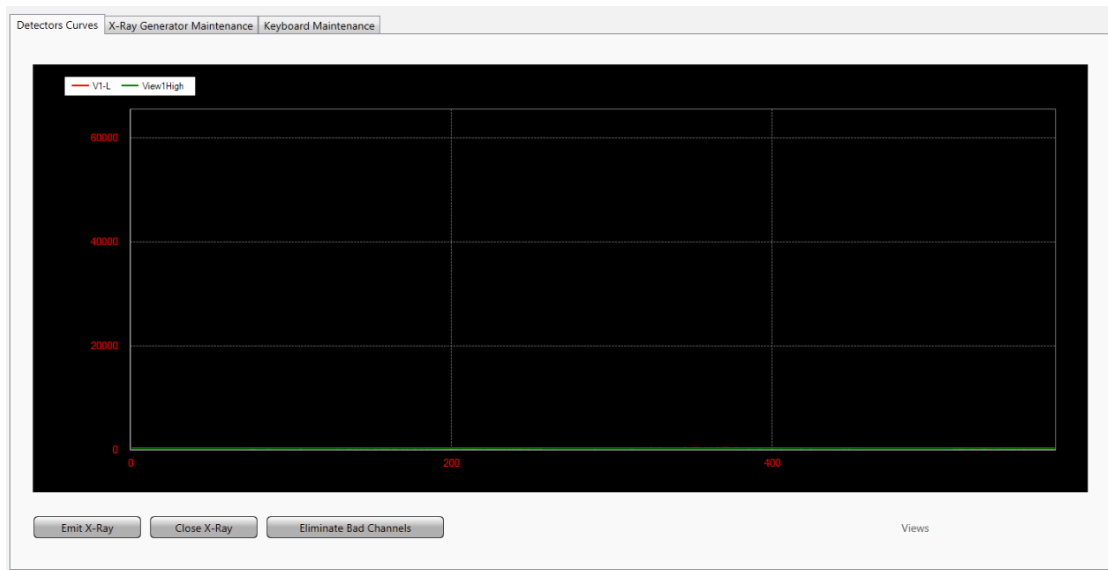

Figure45: Diode Diagram

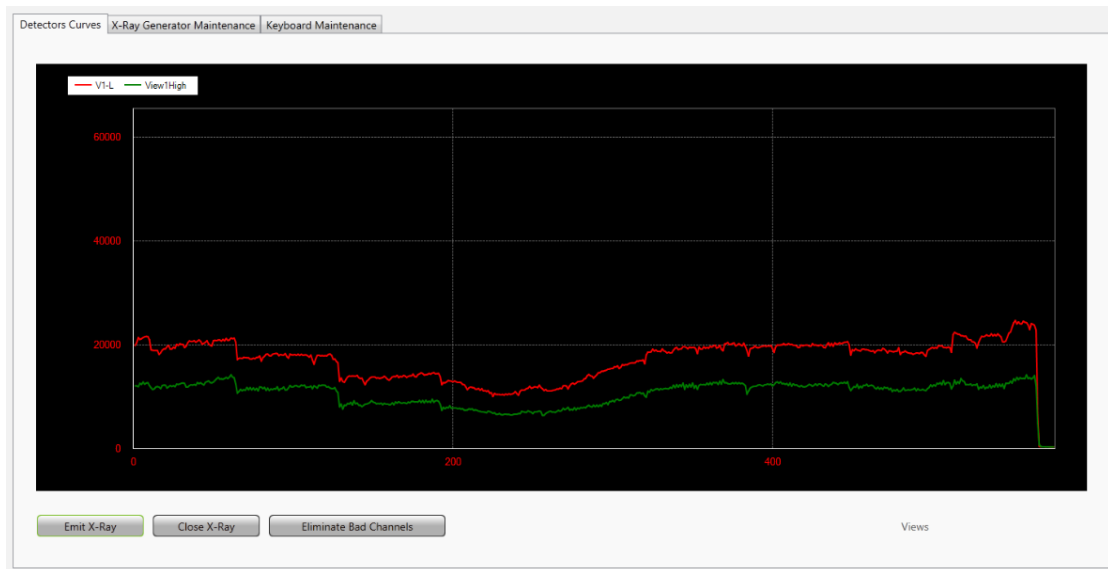

Figure46: Diode Diagram-Emit X-ray

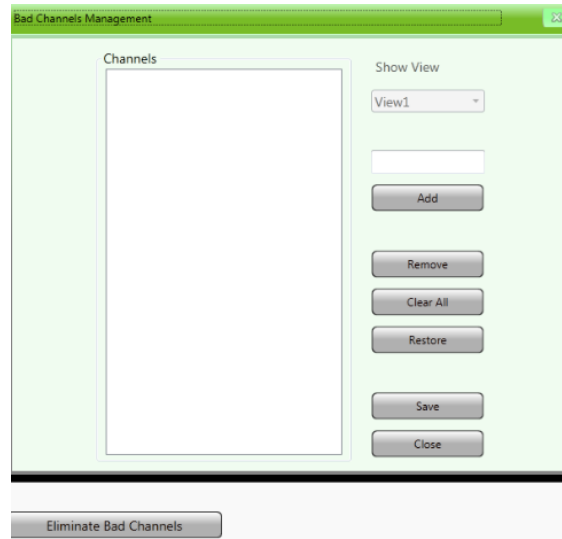

Figure47: Eliminate Bad Channels

2) X-Ray Power:

Voltage Current State

Upon entering **X-ray Power** sub menu, voltage and current of X-ray generator can be set pressing number key in control keyboard. Real value of voltage and current will appear in **real work** after pressing **Emit X-Ray**, **Close X-Ray** must be used to stop emitting X-ray.

Equipment communication status

Forward, **Stop**, **Backward** can be used to test whether the motor can work properly. **Buzzer on**, **Buzzer off** can be used to test whether the Buzzer can work properly.

Motor Power

Upon moving belt, working value of **Voltage/Current/Frequency/Power/Speed** will appear in **Real Work**.

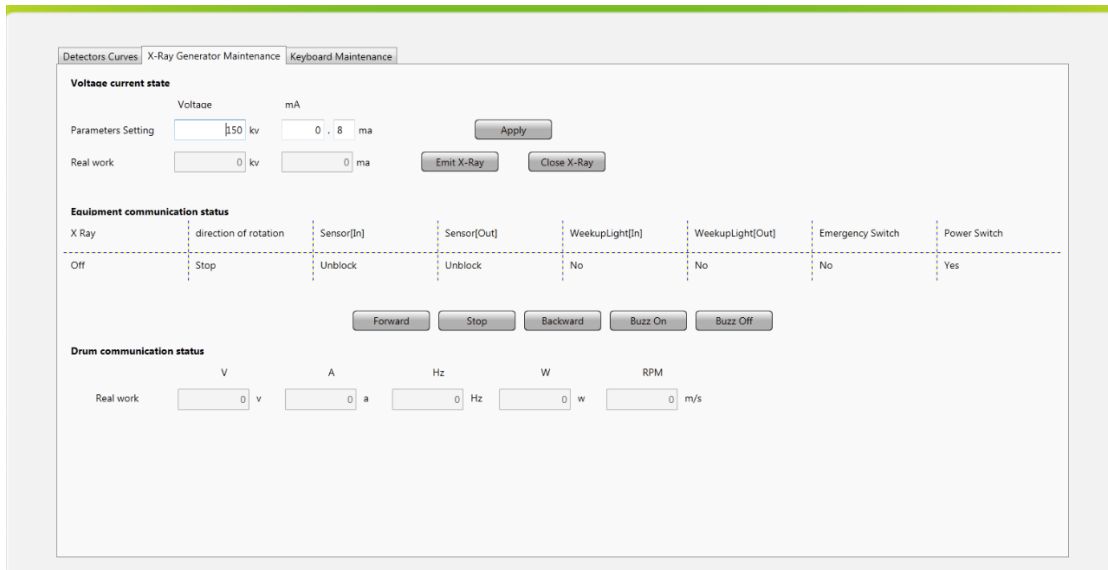

Figure48: X-Ray Power

3) Keyboard Maintenance:

Keyboard Maintenance used to check whether each key in control keyboard can work properly. Upon pressing a key in control keyboard, the corresponding position in screen will light if the control keyboard connected well.

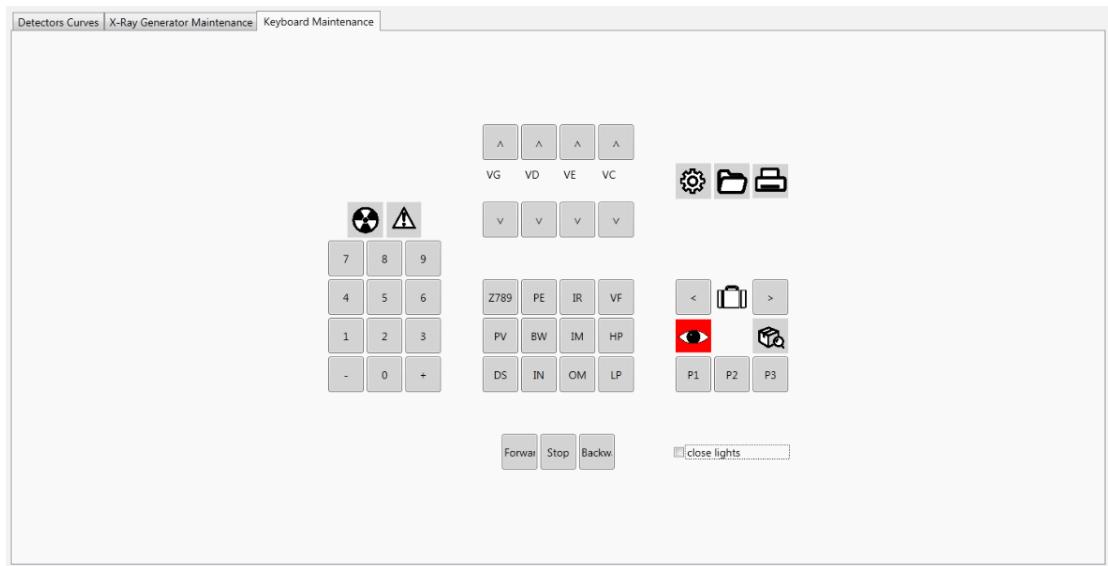

Figure49: Keyboard Maintenance

Training Mode

If the system is operated in the training mode after the user's ID and password, which has been defined before to the system, is entered, simulated images appear on the screen in turn, without the turning of the belt upon pressing the belt movement button. All the functions applied in the display mode are also applicable for this mode.

Administration Mode

Screen-operator has no access to enter **Administration Mode**.

Access to the device setting is enabled by entering the settings menu as the system-admin or screen-supervisor

3.4.1 Account Management

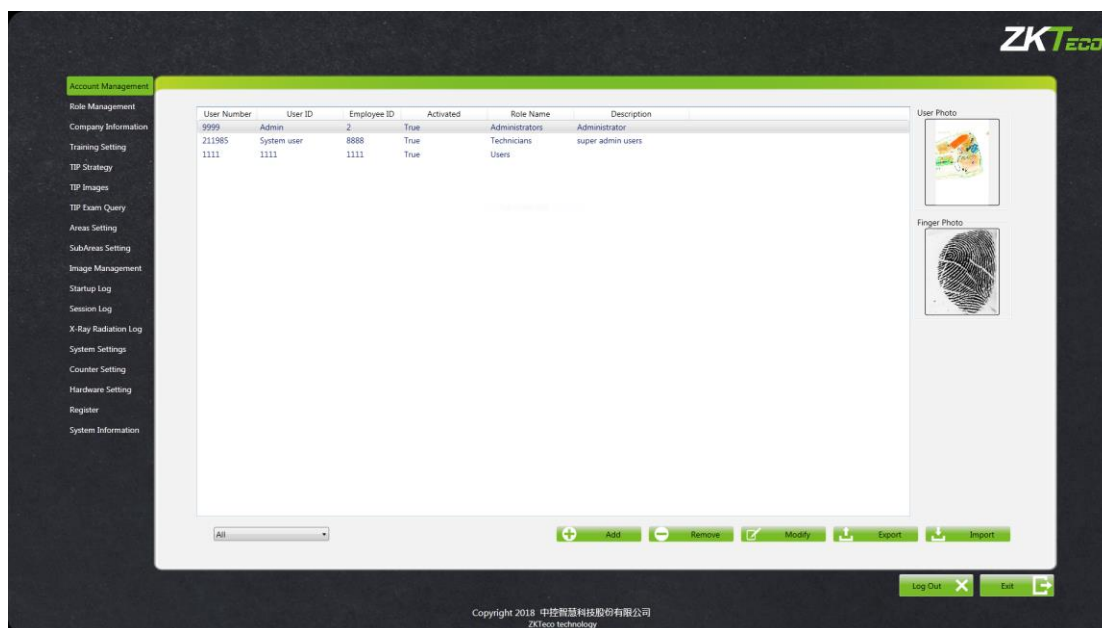

Add: Click "add" to add a new operator account. User ID and password can only use no more than 8 digits. Meanwhile, user also can use fingerprint to log in. **Fingerprint** must be activated. The fingerprint reader contains storage device which can store fingerprint data of 65535 users and each user can store up to 10 fingerprints, the user names to log in by fingerprint should within the range of 1-65535. **Add User Photo** could be used to add a user photo, **Add Finger Photo** could be used to add a fingerprint photo.

Users Information

User Number: 9999 Activated Finger Enabled

User ID: Admin New Password:

Employee ID: 2 Confirm Password:

Role Belongs To: Administrators

Company Belongs To: 某某股份有限公司

Description: Administrator

User Photo:

Finger Photo:

- 1) **Modify:** To click "**Modify**" can also enter into User edit interface to edit personal data.
- 2) **Delete:** Click "**Delete**" to delete the user (operator) who will not use this equipment any more.
- 3) **Import/Export:** This function allows administrator to import/export the account group information (only for Blade Series, document type is XML).

Notice: Once the user is deleted, it cannot be recovered. Please be careful during deleting users.

3.4.2 Access Levels Management

It is arranged from this sub-menu which menu and sub-menus any persons, who have been assigned as user, will have access to. Apart from the access levels defined to the system before, new access levels may be added, deleted or access functions may be arranged.

ID	Role Name	ID	Function Name
1	Technicians	1	Device Maintenance
2	Administrators	2	TIP Images
3	Users	3	Training
		4	Intelligent Identification
		5	Startup Log
		6	Session Log
		7	Screening
		8	X-Ray Radiation Log
		9	Administratian
		10	TIP Exam Query
		11	Image Setting

Figure50: Access Levels and Functions

Which functions are indicated by the access level selected are shown above.

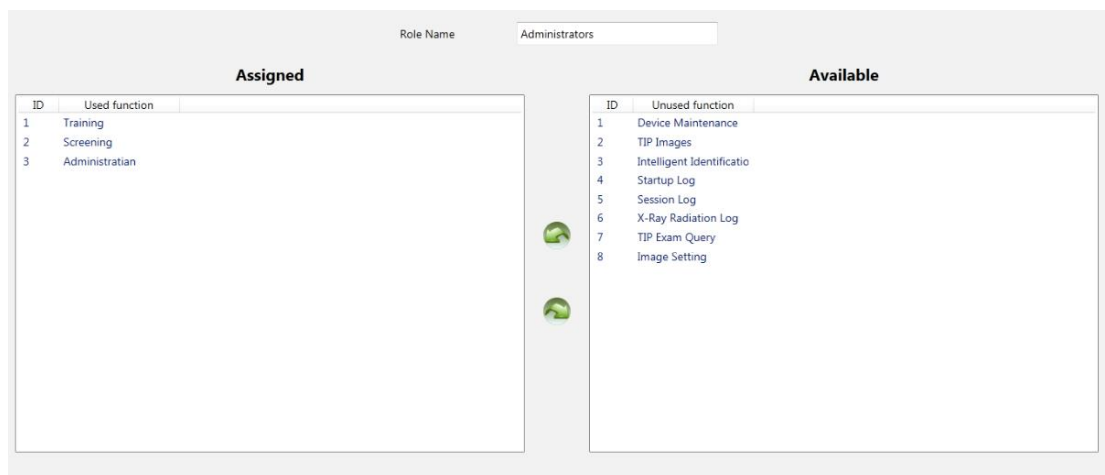

Figure51: Edit Functions Screen

Adding or removing any functions comprised by the access level is accomplished by moving the selected function to the right or left part on the screen.

Descriptions of Functions:

- **Screening**
Access to screening mode from Login screen
- **Training**
Access to training mode from Login screen
- **Administration**
Access to administration mode from Login screen
- **Device Maintenance**
Access to maintenance functions like Diode Diagram, Diode Bug, Diagnostic, X-ray Power and Keyboard maintenance.
- **Intelligent Identification**
Access to High density alert and Drugs and Explosives Inspection Menu under Configuration
- **Post Processing Configuration**
Access to Post Processing Configuration menu under Configuration
- **TIP Strategy**
Access to TIP Configuration menu under Administration
- **Startup Log**
Access to Startup menu under Administration
- **Session Manage**
Access to Session Management under Administration
- **Hardware Setting**
Access to Hardware Setting and Other Setting under Configuration

3.4.3 Company Information

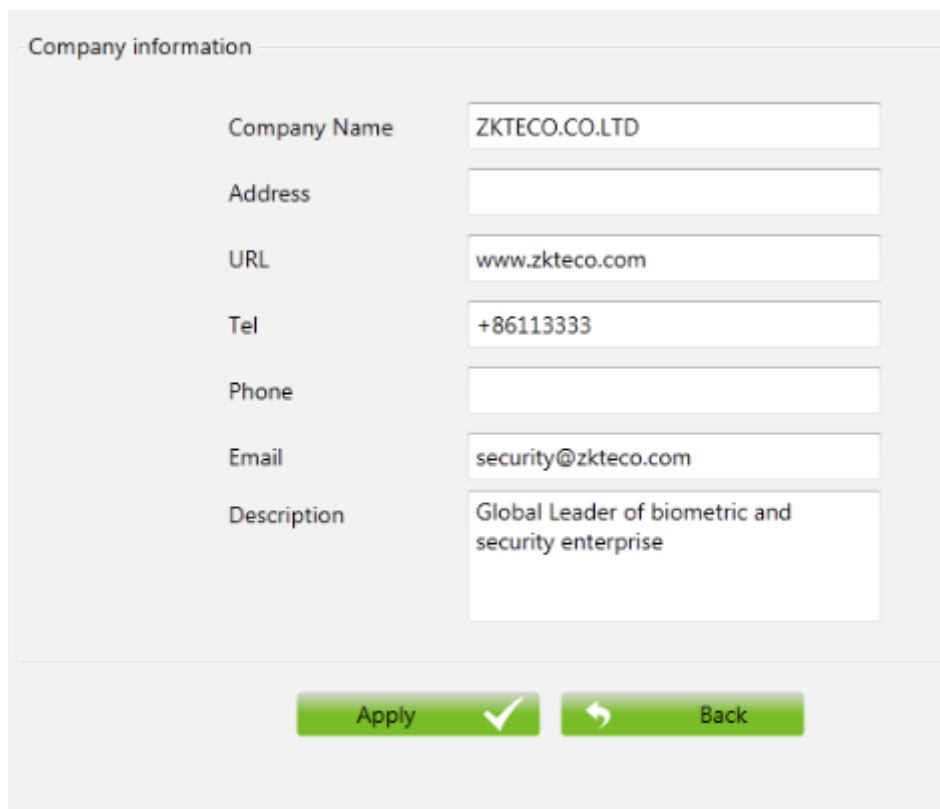

Company information

Company Name	ZKTECO.CO.LTD
Address	
URL	www.zkteco.com
Tel	+86113333
Phone	
Email	security@zkteco.com
Description	Global Leader of biometric and security enterprise

Apply ✓ Back

Figure52: Company Information

3.4.4 Training Setting

Upon entering Training Setting sub-menu, the following screen is displayed.

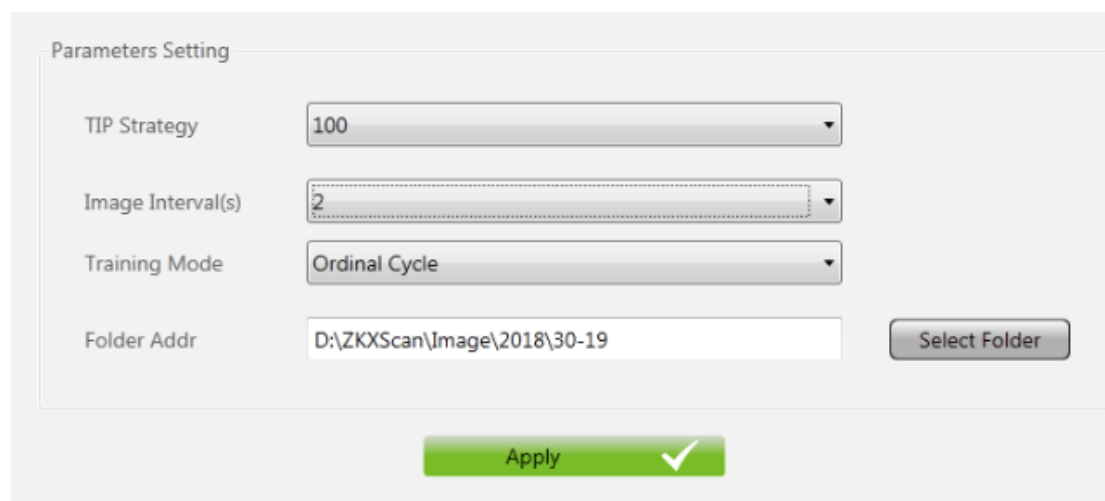

Parameters Setting

TIP Strategy	100	
Image Interval(s)	2	
Training Mode	Ordinal Cycle	
Folder Addr	D:\ZKXScan\Image\2018\30-19	Select Folder

Apply ✓

Figure53: Training Setting

TIP Strategy must be selected to used.

Image intervals: Set the displaying time interval between neighboring images. Select "Image

interval" by control cursor and set the time interval, such as "1", "2" or other time intervals deemed appropriate by the administrator. The setting range is between 0-3 seconds.

Training mode: After selecting this function, control the cursor to click the pull-down list which will show "Single time", "Sequential circulation", "Random circulation" and other modes. The operator can select "Training mode" based on specific need.

Select Folder button must be pressed to choose an image folder where training images come from.

3.4.5 TIP Strategy

Strategy Name	Enabled	Priority Level	Begin Time	End Time	User type	Projection Percent(%)	Dynamic Judgement Time(3-6s)	Static Judgement Time(3-20s)	Creation Time
102	<input checked="" type="checkbox"/>	1	7/1/2017	10/31/2019 11:59:00 F		100	3	3	7/30/2018 3:26:03 PM
101	<input checked="" type="checkbox"/>	10	4/27/2018	12/31/2018 11:59:59 F		100	4	6	4/27/2018 5:56:35 PM
100	<input checked="" type="checkbox"/>	10	4/27/2018	12/31/2018 11:59:59 F		100	6	18	4/27/2018 5:56:24 PM

Figure54:TIP Strategy

It can set TIP basic information and projection percent.

Basic information: Upon entering a TIP Strategy sub menu, there are Strategy name, priority level (1-10), begin time, end time, user type, projection percent, dynamic judgement time and static judgement time. The **"Modify"** button enables the modification of below figure:

Figure55:TIP Strategy

Strategy Name: Set the strategy name according to training records and query needs;

Enable: Means the TIP initiate mode which can be set as on or off, when checking "√", it means the TIP is on; when not checking "√", it means the TIP is off. In addition, the following settings can only be initiated when the TIP is in "ON" state;

Priority level: The administrator will set the priority levels (1-10 levels and 1st level is the lowest level) for newly built assessment items. TIP Strategy with highest levels will be used in priority if there is more than one TIP strategy enabled.

User Type: Select an Access Level which TIP Strategy will work.

Projection percent: Means the percentage to insert dangerous images in the training image folder;

Dynamic judgement time: If there is TIP image appear during scanning or training, the Maximum effective time that **STOP** key must be pressed. When the effective time is exceeded, the system will automatically determine that it is miss.

The **Dynamic judgement time** is implemented for when the belt is moving, judge time is 3 seconds means the screener has 3 seconds to make an identification of the threat. The **Dynamic judgement time** can be varied from 3 to 6 seconds.

Static judgement time:



After pressing **STOP** key, the Maximum effective time that key must be pressed. When the effective time is exceeded, the system will automatically determine that it is miss.

Static judgement time is for when the belt stopped for 3 seconds, means the screener has 3 seconds to mark the TIP images. **Static judgement time** can be varied from 3 to 20 seconds.

Proportion Setting: The frequency of insertion of the TIP image is arranged here.

3.4.6 TIP Library

TIP images are consisted of Cashes Explosives, Fruits, Guns Knives and Others. The "**Export**" and "**Import**" button enables to export and import TIP images(only in the format of Blade). The "**Remove**" button enables the deletion of any category.

3.4.7 TIP Exam Query

Upon entering the **TIP Exam Query** sub-menu, the following screen is displayed.

User ID	Date	Scanned Luggages count	Inserted Tip count	Marked Tip count	Missed Tip count	Missed Rate
---------	------	------------------------	--------------------	------------------	------------------	-------------

Figure56: TIP Exam Query

User Group and Statistics Times must be selected to query TIP exam result. There is 4 kind of Statistics Period: Day(In the Month), Week(In the Year), Month(In the Year), Season(In the Year).

Day (In the Month): statistical period is one month, sub-period is one day. The machine will search each day's data in the month which selected **Statistics Time** in.

Week (In the Year): statistical period is one year, sub-period is one week. The machine will search each week's data in the year which selected **Statistics Time** in.

Month (In the Year): statistical period is one year, sub-period is one month. The machine will search each month's data in the year which selected **Statistics Time** in.

Season (In the Year): statistical period is one year, sub-period is one season. The machine will search each season's data in the year which selected **Statistics Time** in.

3.4.8 Station Location Sub-menu

In the sub-menu station location, it is possible to make changes in the sites, sub-sites location, to amend or delete the information of those defined.

On this screen, the user may see the sites available. He/ She may open site adding screen using "Add Site" button by using the touchpad on control keyboard or may go site editing screen using "Modify Site" button after selecting the site desired to be edited or may delete selected site using "Remove Site" button.

Name	Code	State	City	Phone	Fax	Email
MYSOLUTION	88888888	NARMOL	GUANGZHOU	188888888888	188888888888	188888888888@xxx.cc



 Add  Remove  Modify

Figure57: Site Sub-menu

Area information

Name	MYSOLUTION.CO.LD
Code	88888888
State	NARMOL
City	GUANGZHOU
Phone	188888888888
Fax	188888888888
Email	188888888888@xxx.com

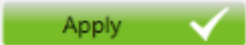

 

Figure58: Modify Site Sub-menu

3.4.9 Sub-Site sub-menu

“**Sub-Sites**” menu is shown in the below illustration. On this screen, the existing sub-sites are listed, changes may be made on these sub-sites through the buttons at the bottom, a new sub-site may be added or the deleting action may be performed.

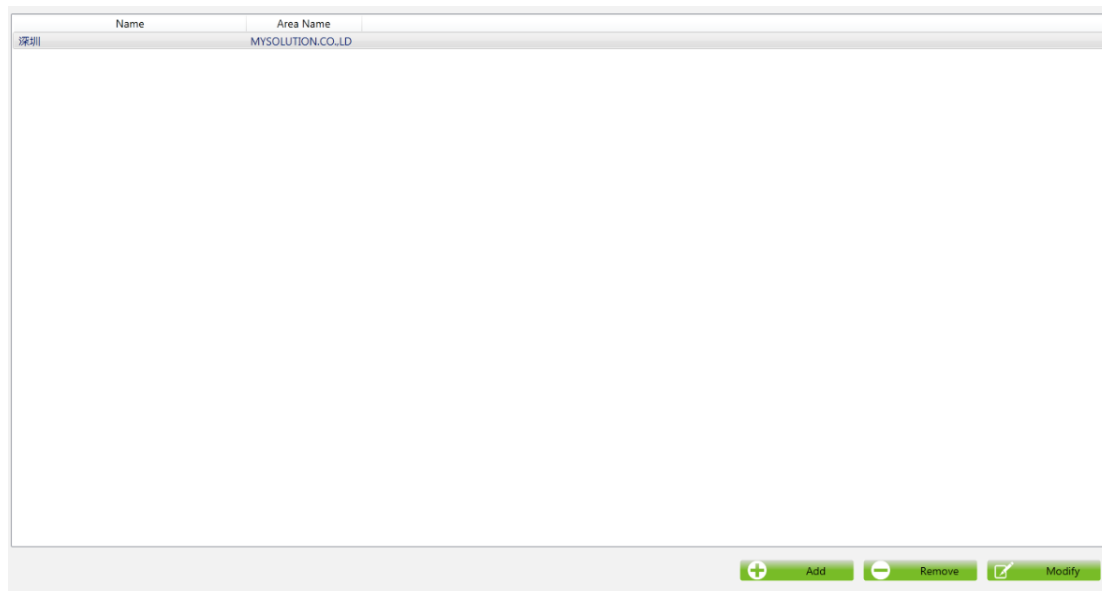

Figure59: Sub-Site sub-menu

Log Management

The system health can be viewed from this sub menu under Administration, the fault messages and working conditions that machine had are listed in this menu. Log management is consisted of "Startup log", "Session log" and "X-ray radiation log". The user can enquire qualified using record by corresponding conditions.

3.4.10 Startup Log

It could search by Week (in the year), Month (in the year), and Season (in the year) .Statistic time indicates the start time in each period.

Export: User could select single or several records to choose records that need to export. The data will export as CSV file.

Statistics Period: Day(In the Month) Statistics Time: 2019-01-05 Query Export

Date	Work Time
2019-01-01	00:00:00
2019-01-02	03:06:22
2019-01-03	00:24:30
2019-01-04	00:18:02
2019-01-05	01:01:15
2019-01-06	00:00:00
2019-01-07	00:00:00
2019-01-08	00:00:00
2019-01-09	00:00:00
2019-01-10	00:00:00
2019-01-11	00:00:00
2019-01-12	00:00:00
2019-01-13	00:00:00
2019-01-14	00:00:00
2019-01-15	00:00:00
2019-01-16	00:00:00
2019-01-17	00:00:00
2019-01-18	00:00:00
2019-01-19	00:00:00
2019-01-20	00:00:00
2019-01-21	00:00:00
2019-01-22	00:00:00
2019-01-23	00:00:00
2019-01-24	00:00:00
2019-01-25	00:00:00
2019-01-26	00:00:00
2019-01-27	00:00:00

Log Out X Exit

Figure60: Startup Log

3.4.11 Session Log

User Number: All Start Time: 2019-01-05 Statistics Period: Query End Time: 2019-01-05 Query Export

User Number	Login Time	Logout Time	Work Time
1111	1/5/2019 4:12:15 PM	1/5/2019 4:15:04 PM	00:02:48
1111	1/5/2019 4:05:53 PM	1/5/2019 4:08:44 PM	00:02:50
1111	1/5/2019 2:15:56 PM	1/5/2019 2:16:40 PM	00:00:43
1111	1/5/2019 2:09:37 PM	1/5/2019 2:09:51 PM	00:00:14
9999	1/5/2019 2:06:33 PM	1/5/2019 2:07:47 PM	00:01:13

Figure61: Session Log

User Number: Choose specific user or select all users.

Statistics period: It is same as running log. Working log also could search by Day, Week, Month and Year.

Start Time and End Time must be selected before pressing Query button, User Number, Login Time, Logout Time, Work Time can be checked in this sub-menu.

3.4.12 X-ray Radiation Log

Targeted mainly at X-ray generator, record the using time of X-ray generator within query data range so that the administrator can get hold of the running condition of the equipment. Select the needed records from query result and the records can be exported. The export operation can refer to the above export operations.

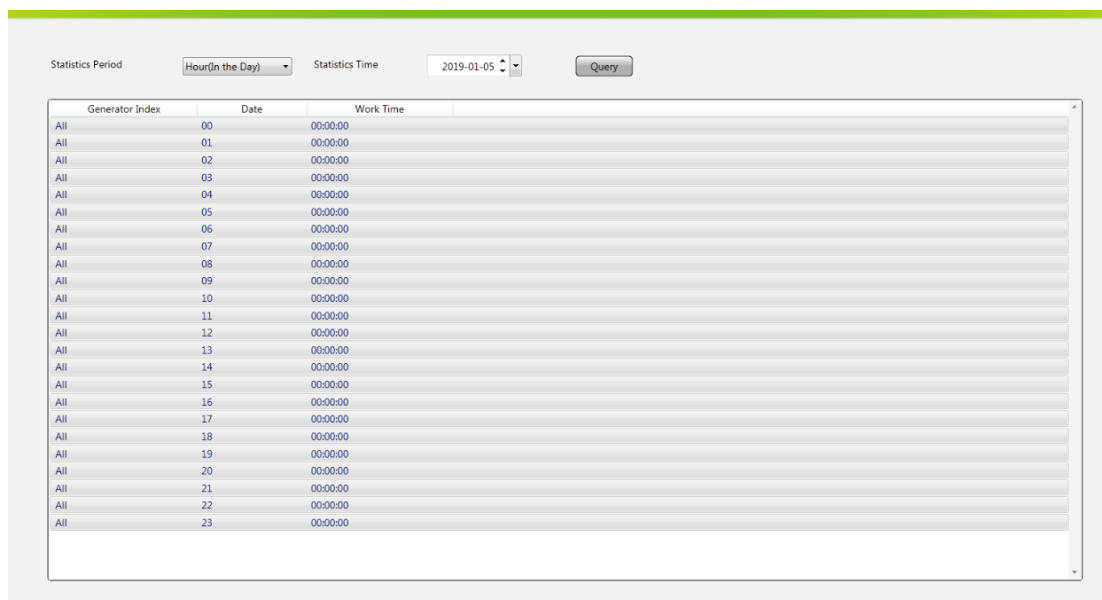

Generator Index	Date	Work Time
All	00	00:00:00
All	01	00:00:00
All	02	00:00:00
All	03	00:00:00
All	04	00:00:00
All	05	00:00:00
All	06	00:00:00
All	07	00:00:00
All	08	00:00:00
All	09	00:00:00
All	10	00:00:00
All	11	00:00:00
All	12	00:00:00
All	13	00:00:00
All	14	00:00:00
All	15	00:00:00
All	16	00:00:00
All	17	00:00:00
All	18	00:00:00
All	19	00:00:00
All	20	00:00:00
All	21	00:00:00
All	22	00:00:00
All	23	00:00:00

Figure62: X-ray Radiation Log

3.4.13 System Setting

Series Number of the machine appear under System Setting menu, which is unique to each machine.

He/ She can select a language required, now that the machine has provided English, Chinese, Arabic, Russian, Spanish, Turkish 6 languages.

Virtual keyboard must be activated if he/she wish to use it.

Time Zone could be set according the installation location.

Daylight Saving Time could use to adjust display time with Daylight Saving Time if required.

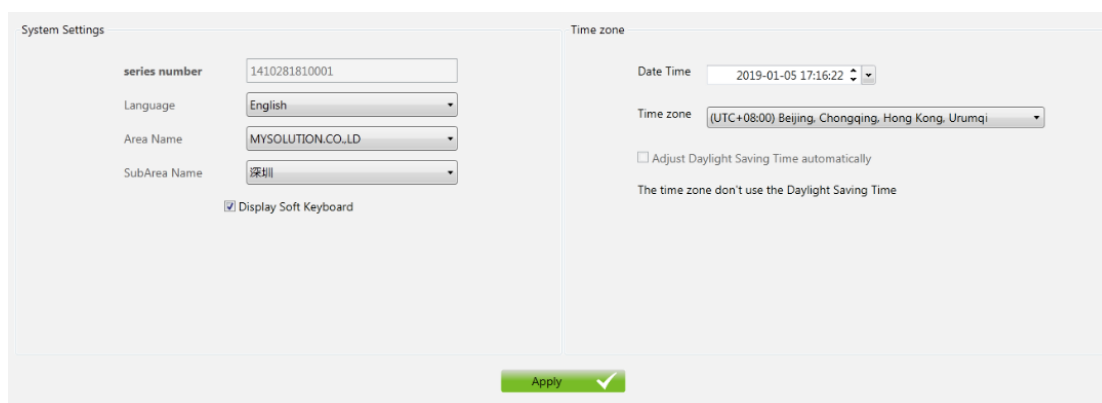

Figure63: System Setting

3.4.14 Counter Setting

Total Images: Number of all scanned images which store in baggage scanner.

Temporary Images: Number of scanned images which have been created from the latest start up baggage scanner.

Display: He/she can select an images counter mode to display in User Screen.

3.4.15 Hardware Setting

If the option **Reverse Motor Direction** is on, the belt moves in the opposite direction of the belt movement buttons from the control keyboard.

If **Energy Saving Mode option** is on, belt will move a circle automatically when there is a baggage put on the belt. Note: baggage must be put on the entrance side.

If **Continuous Scan mode options** is active, even if the object is not detected by the sensor while the belt is moving system activates x-ray generation.

Other Setting

Limit and No limit means how long X-ray device will run when power failure occurred. For example, if the main power off, a machine which **No limit** is activated will shut down at once. Same situation, a machine which **Limit** is 10 minutes will shut down after 10 minutes.

Fingerprint Setting

Upon pressing Fingerprint Initialize button, the fingerprint data base will be reset.

Note: After initializing Fingerprint, all fingerprint data store in X-ray device will be deleted and cannot recover. After pressing the button, the question "Do you want to initialize the fingerprint database?" is displayed on the screen.

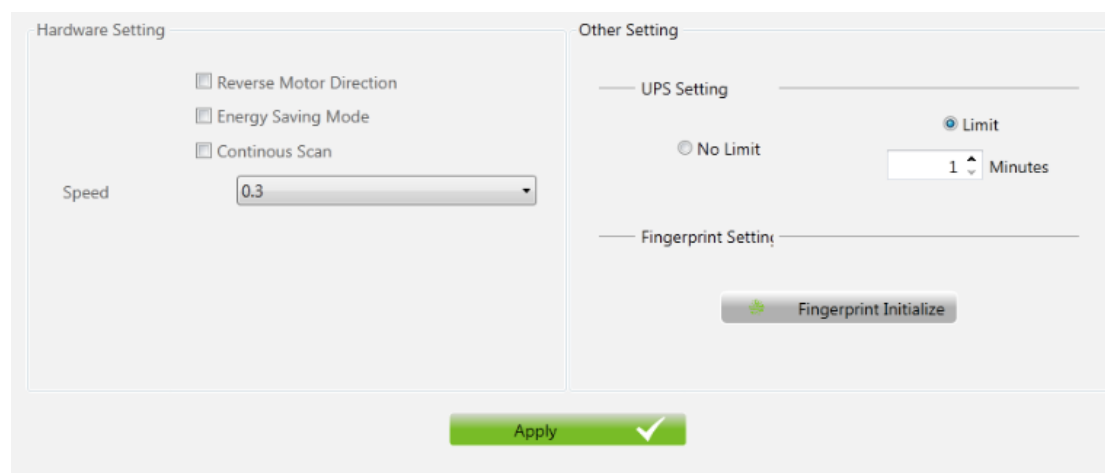

Figure64: Hardware Setting

3.4.16 Register

The screenshot shows a 'Register' window with the following fields and values:

- The Machine Code : 00-30-18-59-da-13
- License type : Standard License
- The Register Code
- 64645-47c3-dbe7-7646-4e464

An 'Apply' button is located at the bottom center of the window.

The Machine Code and The Register Code is unique to each machine. Before registering, ZK X-ray machine cannot scan more than 10 images every start up. If above situation occurs or The Register Code is empty, please contact with device supplier.

3.4.17 System Information

Working Condition

X-ray Emitted Time: Under this menu, he/she can check X-ray generator working time. If the time is over 10,000 hours, please contact with device supplier to replace X-ray generator.

Total Work Time: The x-ray device total work time can be checked here.

Current Work Time: The x-ray device work time from the latest start up.

Free Disk Space: The remaining storage space of the hard disk, if the space under 50GB. Some old scanned images should be deleted from hard disk after exporting out.

Configuration

Under Configurations sub-menu, Series number, Version, Current images, Total images are displayed on screen.

The screenshot shows two panels of system information:

Running Time Statistics Info	
X-Ray Emitted Time:	0h 1m 41s
Total Work Time:	102h 31m 43s
Current Work Time:	0h 4m 22s
Free Disk Space:	899.8 GB

Configurations	
series number	1410281810001
Version	2.2.8
Current Packages:	0
Total Packages:	7046

Figure65: System Information

4 Installation and Configuration

ZKTECO does not in any way assume any liability for any accidents, which may arise during the network connection, for wrong connections and any faults, which may occur as a result of any configurations to be made by unauthorized persons over the system software. System installation must be carried out by Authorized Blade Technical Service Personnel.

Lifting and Moving the Machine

Unpack the machine, and lift-up from the palette using a forklift, capable of carrying a minimum 600kg (13241bs). Place the forks underneath the long side of the machine, between the wheels. Lift-up, and carry the machine where it'll be installed. Then carefully put it down on the ground on its wheels. You can make additional adjustments by moving the machine on its wheels. Finally, adjust the four stability feet, located underneath the chassis, at the four corners of the machine.

The ground on which the device will be installed should be level. The space to be left on the right and left of the device should be left sufficiently wide to allow side covers to be opened easily. The place where the device will be used shall be opened to allow four fixing screws, which are located on the sub-chassis of the device, to be placed on the ground for fixing purposes, and the sliding of the device on the wheels should be prevented.

The monitor box should be opened and the monitor taken out, and after the monitor base has been mounted. Put it onto the console. Connect the monitor cable on the device or on the console cable to the socket behind the monitor. Plug the socket of the energy cable next to this cable to the energy input socket of the monitor. Place the control panel of the device on the console. Keyboard can be fixed to the console through triangle key put in tools box. The keyboard cable ends must be connected to the sockets on the console cable, and finally the main power inputs of the device are connected to the local network, if any.

Power Supply

The following electrical data are standard values of the x-ray devices of the Blade series. They may vary with mobile systems or special ordered models.

Electrical Values	AC110V (-15%~+10%)/ AC220V (-15%~+10%)	50/60 Hz
	600W	

Figure66: Electrical Values

Electrical fluctuations which may occur in the network should not exceed+/-1 0%.

Environmental Conditions

The following electrical data are standard values of the x-ray devices of the Blade series. They may vary with mobile systems or special ordered models.

Altitude	2000M maximum	
Temperature of use	0°C~45°C	
Temperature of storage	-20°C~50°C	
Relative Humidity	5%~95%	Non-condensing
Environment of Use	Inside building	
Installation Category	second	
Pollution Degree	2	

Figure67: Environmental Conditions

Electric Power Cable

The electrical supply cable comes is standard and is supplied with the Blade devices.

If a different type of power socket is supposed to be used, the connection status of the power cable should be as follows.

Phase: Black

Neutral: White

Ground: Green/White (Green/Yellow)

The plug type to be used should provide for minimum 10 Ampere and shall comply with the safety and quality standards of the country in which it is used.

5 Periodic Maintenance



Attention

During cleaning, water or other liquids must be prevented from getting into the device. Outer surfaces of the device must be wiped by a moist cloth.

If you would like to access inside the device, shut the device down and unplug the power supply cable. Computer keyboard with the device is for the use of only technical service engineer. This keyboard may not be used by the user. Since some covers of the device are heavy. They must be lifted by two persons.

Periodical Weekly Maintenance

Physical condition of the device must be inspected in weekly maintenance and outer surface must be cleaned.

Preparation:

Read carefully all the warnings in this section. Remove the key from the ON/OFF switch of the device after shutting down. Disconnect the energy of the device's power supply cable.

Visual inspection:

Inspect outer covers, conveyor belts, lead curtains visually. Replace defective components.

Conveyor Belt and Outer Surface of the Monitor.

Clean outer surface of the monitor and conveyor belt using a moist cloth.

Monitor Screen

Clean the monitor screen by means of anti-static spray or cloth.

Quarterly Maintenance

Preparation:

Read carefully all the warnings in this section. Remove the key from the ON/OFF switch of the device after shutting down. Disconnect the device's power supply cable.

Attention: During cleaning, prevent that water or other liquids enter the device. Outer surfaces of the device must be wiped by a moist cloth.

Outer Surface of the Device

Wipe outer surface of the device using a soft cloth. A damp soapy cloth may be used during cleaning, dry all wet parts of the device using a dry cloth after cleaning.

Lead Curtains

Inspect lead curtains visually which are located entrance and exit of the device and remove any

luggage tag or other debris stuck to them. Wipe using a moist cloth. If any curtain is worn or torn, replace a new one.

Conveyor System

1. Visually inspect conveyor belt and check if there is any debris stuck to the joint part. Clean it using a wet cloth. If there are any worn or torn parts, replace the belt with a new one.
2. Check tension cylinders of conveyor belt visually. Replace if worn.
3. Check and make sure there is no oil leakage on conveyor motor side. Should there be oil, inform the technical service.

Conveyor Movement

1. Press "Next" button of the motor and ensure the conveyor belt moves forward.
2. Check any unusual sound from system tension cylinders. Check whether conveyor belt is centered. There must be at most 10 mm space from either sides.
3. Stop conveyor belt pressing the "Stop" button.
4. Check condition of the conveyor belt pressing the "Back" button of the motor.

Radiation Leakage Measurement

Measure the radiation leakage at the devices outer surface while the x-ray is on, by using a high sensitivity dosimeter, e.g. FLUKE 451P or Victoreen 451p. This value must not exceed 1 microSv/hour for external surface and 2.5 microSv/hour for inner surface.



Measure the radiation leakage after installation and commissioning; and also after any repair or modification to make sure that equipment remains safe.

6 Troubleshooting

Guarantee

Blade x-ray devices are designed as to require little maintenance. The scope of guarantee does not cover failures occurring after unauthorized maintenance by others within the guarantee period.

The device may be inspected by technical staff of the user company before calling device engineer for the problems related to the technical issues outlined in this manual. If the system does not start up, read installation section. If no solution is found in this section, follow the steps specified below. If the system is energized, please enter the maintenance mode and first check the system that way.



Attention

Following actions must be carried out by trained technical staff. Side covers must not be removed with the system power up. It must be inspected after power connection of the device is cut. The device has high voltage inside.

Device does not start up

Check:

- Check that the Power cable is connected to the machine and to the local service.
- Check if package switch is ON which is located on power input socket of the machine.
- Check if the main circuit breaker is ON.
- Check if the connector located on the cable termination of the control keyboard is screwed to the connector from machine.
- Check monitor power cable of the machine is plugged and power on button is open. Turn opening switch of the device console clockwise.

If the device does not start up after aforementioned check-ups, unplug power cable and remove protection covers unscrewing screws fixing side covers.

NOTE: Pay attention to warning signs inside and outside the machine. In case of any technical failure, call authorized technical service.

X-Ray Is Not Generated



Unplug power cable of the device. Open side service covers of the device.

Check:

- Make sure the emergency stop buttons of the system are not pressed.
- Check the limited switch in bottom of both side. There are protection contacts in limited switch and x-ray generator does not start up while the contact is open.
- Check the power cable of X-ray generator, make sure the button next power cable is On.
- There is an input socket placed on the x-ray supply box in I501A,1701A, 1801A x-ray generator models.
- Should you have not obtained a favourable result from aforementioned steps, **“Call Technical Service”**

Conveyor Motor Does Not Function

Check:

Unplug the energy cable and open the side covers.

Check:

Check the “F2” fuse. It is located on the main power distribution board.

Some motors have thermal contact and opens the circuit when the motor is too hot and stops the motor. The motor may start up again after cooling down. If the motor gets too hot, technical service must be notified.

System Uninterruptable Power Supply (AC220 V, 50/60 Hz)

The device contains an uninterruptable power supply feeding the computer. On button must be pressed to start UPS. There are LCD screen showing energy conditions on front surface of the UPS.

Description, if the icon is illuminated:

1 On Line - The UPS is supplying utility power to connected equipment

2 Power-Saving - Master and controlled outlets are enabled, saving Power when the master device goes into sleep or standby mode

3 Load Capacity - the load is indicated by the number of sections illuminated, one to five. If the load exceeds the rated capacity, the Overload symbol will flash off and on.

4 Battery Charge - the battery charge level is indicated by the number of sections illuminated. When all five blocks are illuminated, the Back-UPS is at full charge. When one block is filled, the Back-UPS is near the end of its battery capacity, the indicator will flash and the unit will beep continuously.

5 Overload - the power demand from the load has exceeded the capacity of the Back-UPS.

6 Event - an event has occurred and the unit needs attention.

7 Automatic Voltage Regulation - the unit is compensating for extremely low input voltage, but is not using battery power.

8 In - Input voltage.

Out - Output voltage.

9 System Faults - the system has a fault. The fault number will illuminate on the display interface.

10 Mute - the audible alarm has been turned off.

11 Replace Battery - the battery is not connected or is nearing the end of its useful life.

Replace the battery.

12 On Battery - the unit is supplying battery backup power to the connected equipment, it will beep four times every 30 seconds.

On Line Mode on Battery Mode

Input Voltage Estimated runtime in minutes

Counter Power Event Counter

Estimated run time Output Voltage

Load in Watts Input Voltage

Load in % Load in Watts

Output Voltage Load in %

Output Frequency Output Frequency

7 Technical Specification, Blade6040

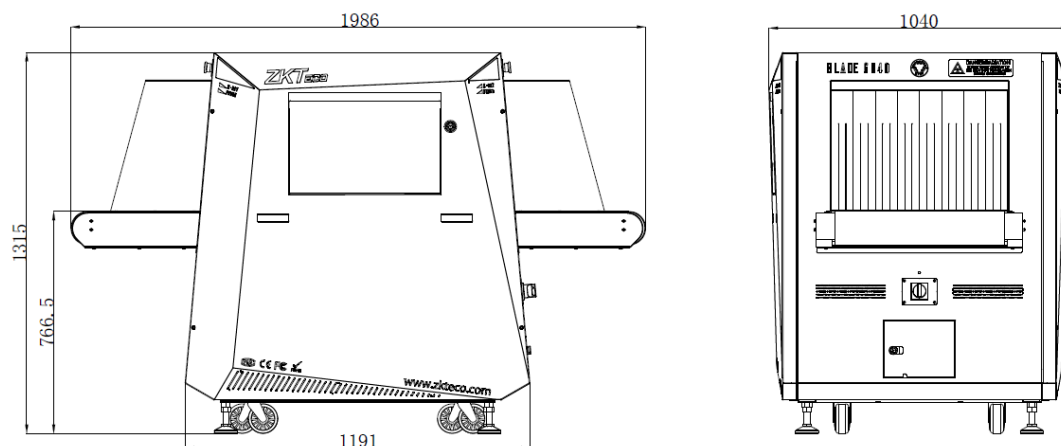

Blade6040

Physical Properties

Dimensions: Length: 1986mm

Height: 1315mm

Width: 1040mm

Tunnel Dimensions: 620mm (W)*440mm (H)

Conveyor Speed: 0.2~0.4m/s

Conveyor Load Capacity: 200KG Evenly Distributed

Conveyor Height: 768mm

Approx. Weight Unpacked: 610KG

System Power: AC110V+/-10%, 50/60Hz, 600W

AC220V+/-10%, 50/60Hz, 600W

X-Ray Generator & Image Performance

Steel Penetration: 38mm guaranteed; 40mm typical

Wire Resolution: 38AWG guaranteed; 40AWG typical

Article Separation: Low Z, Medium Z, High Z to 0.5 Z Accuracy

Generator Cool: Oil and forced air cooling

Anode Voltage: 170kV, operating at 150kV

Tube Current: 0.8 MA, operating at 0.5 MA

Direction of X-Ray: Diagonally Upward

Computer Specifications

Processor: Intel Core I5 (or superior)
Monitor: 21.5 inch LED Color, Non-flicker (or superior)
Memory: 4 GB RAM (or superior)
Video Card: 2 GB (or superior)
Hard Drive: 1TB (or superior)
USB Port: 6 port (or superior)
Operating System: Windows 7

Operating Environment

Storage Temperature: -20°C to 50°C
Operating Temperature: -10°C to 45°C
Relative Humidity: 10%~90% non-condensing

Health and Safety

All ZKTECO CO Ltd products meet all applicable international health and safety regulations. US FDA Federal Standard 21 CFR 1040.10 Health and Safety. Maximum level of radiation the exterior panels come in contact with is 0.1mR/hour.

Film Safety: ISO1600 / 33DIN
CE Compliance: Certified
FCC & IEC Compatibility: Available

Standard Features

Biometric Log In
Dangerous Items Aided Detection
Integrate Walk Through Metal Detector in Blade X-ray Software
Super Enhancement (PV)
Black & White View (B/W)
Organic/Inorganic Separation (OM/IM)
High Penetration (HP)
Dynamic Scan Mode (DS)
Inverse View (IN)
Low Penetration (LP)
Variable Edge Enhancement (+E-E)
Variable Density (+D-D)
Variable Contrast Level (+G-G)
Variable Color Separation (+C-C)

Zoom (128x)
Recall Previous Images Mode
Programmable Function Keys
Automatic Archive
Parcel Counter
Date and Time Display
Virtual Threat Image Picture (TIP)
High Density Alert
Drugs and Explosives Alert
Operator Training Program (OTP)
UPS (For Computer)
Flat Panel LED Monitor
Input-Output Rollers

Optional Features

Central security inspection system
Anti Rat Device
Energy Saving Function
External UPS
Operator Console
Barcode Reader System
Test Kit (STP/ASTM)
Remote Access Connection (SERVER)
External Camera Archiving

Green Label

ZK Building, Wuhe Road, Gangtou, Bantian, Buji Town,
Longgang District, Shenzhen China 518129

Tel: +86 755-89602345

Fax: +86 755-89602394

www.zkteco.com

