

# Installation Guide

---

## AL30B & AL40B

Version: 1.0



# 1. What's In the box

Outdoor unit

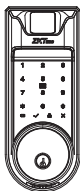

Indoor unit

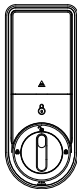

Latch

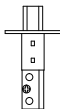

Strike plate



Strike box



Gasket



Keys



Mounting plate

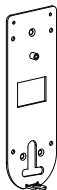



Screw A



Screw B



**Note:** To ensure proper functioning of the lock, use the correct set of screw C as per your door thickness.

Screw C	Screw length	For door thickness
	16.5mm	35-40mm
	30mm	40-50mm
	35mm	50-53mm

## 2. Installation Diagram (AL30B)

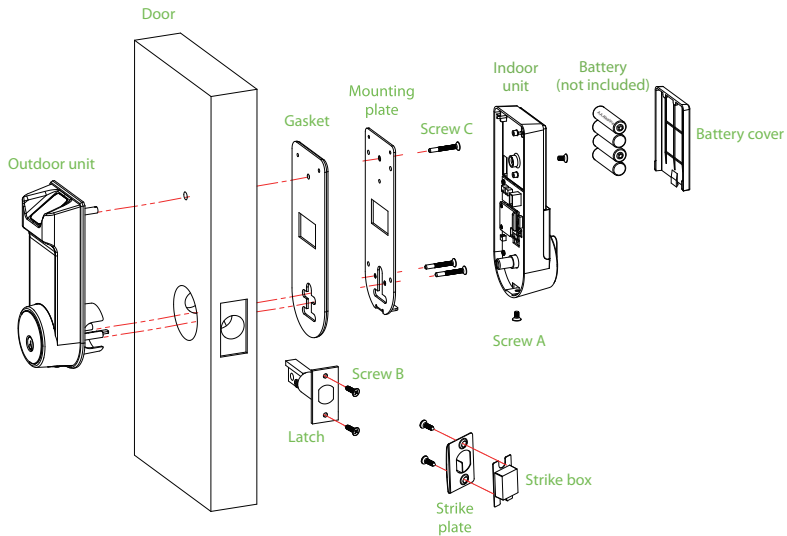

### 3. Installation steps

#### Important notes.

- ❖ Please read all the instructions in this manual or call customer care before returning the product to the store.
- ❖ Whenever you install this lock on any door, you must perform the initialization process just after the installation as described in Initialization step on page 10.

#### Door opening direction recognition.

The handle of the door is determined by the swing (handing) direction of the door. Below is the graphical representation of handing in reference to your location outside the room.

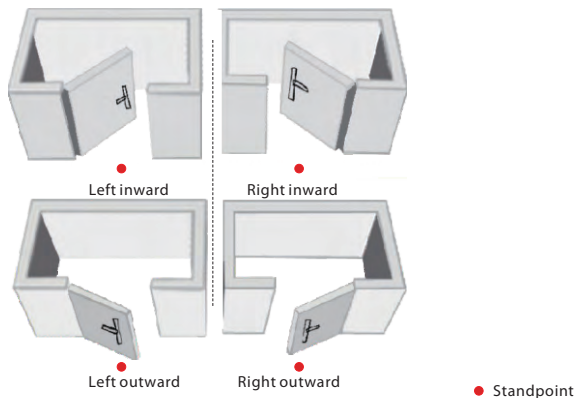

## Drilling holes in the door.

1. Paste the installation template at a desired handle height.
2. Mark the holes and start drilling the holes.

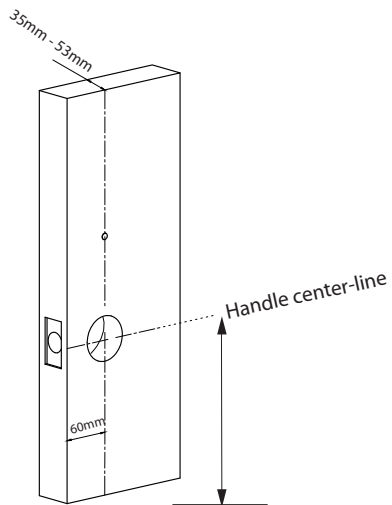

## Adjust the backset of the lock to 70mm (if needed).

Backset is the distance from the edge of the door to the center of the hole drilled on the door.

The default backset is 60mm, if you want to change the backset to 70mm backset, grasp body and twist faceplate as shown below:

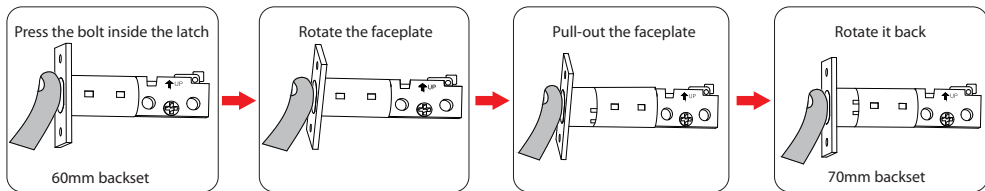

By default, the metal wire runs over the center as shown:

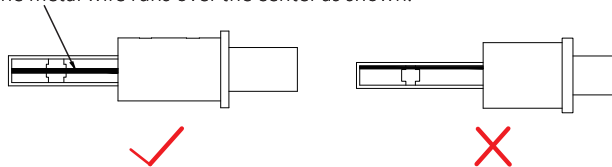

## Installing the latch.

1

Before installing the latch, make sure the latch bolt is in extended (Locked) position and the UP arrow direction is facing upwards.

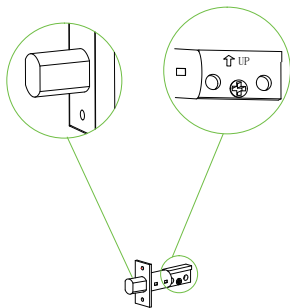

2

Secure the latch by inserting the screws B.

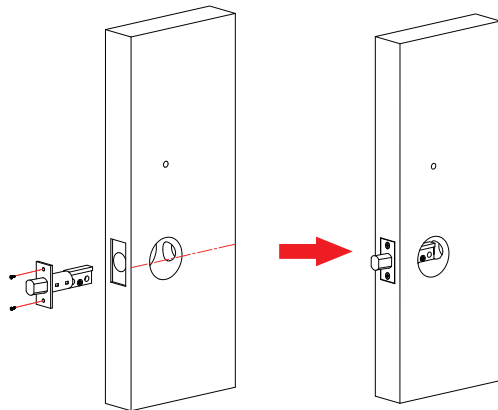

## Installing outdoor unit on the door.

1

Before inserting the unit inside the door, make sure the highlighted spindle is in the vertical position as shown.

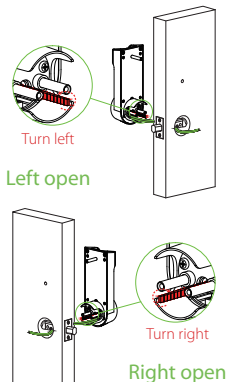

Note:

If the direction of the door is right hand, the rotate the highlighted spindle to the extreme right and if the door is left hand then rotate it to the extreme left.

2

Firstly route the cable under the bolt through the drilled hole. Then attach the outdoor unit to the door by inserting it through the drilled hole.

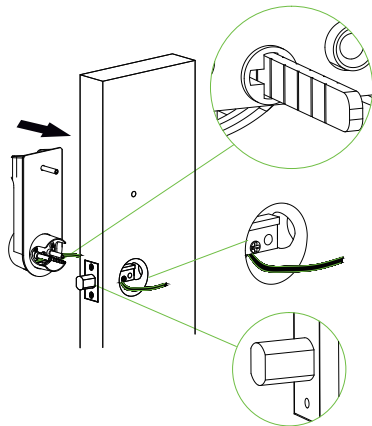

7



## Installing mounting plate with gasket on the door.

1

Attach the mounting plate to the gasket and route the cable through the hole on the mounting plate and gasket.

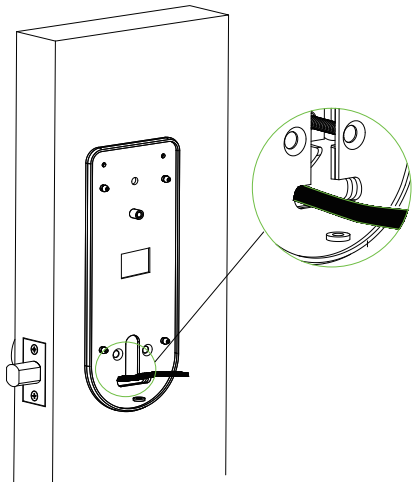

2

Place the gasket and mounting plate on to the door and use screws C to secure them.

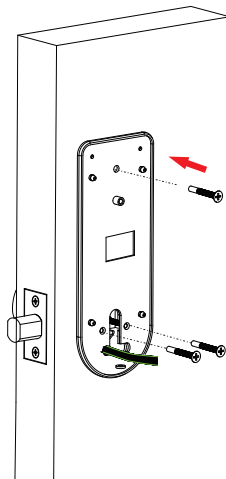

## Installing the indoor unit.

1

Connect the cable connector to the port on indoor unit.

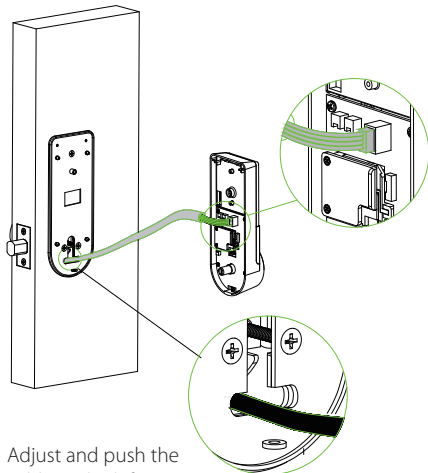

2

Place the indoor unit properly on the mounting plate, push and adjust the excess cable to the left. Then use screws A to secure indoor unit. The knob dot must be in direction of bolt.

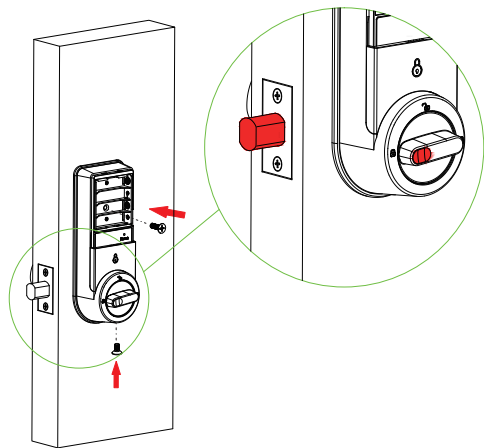

## Insert batteries.

Insert four 1.5V alkaline batteries and install the battery cover.

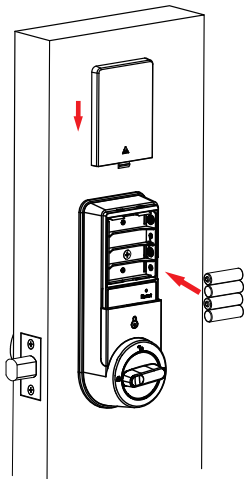

## Initialization of lock.

After installing the lock, you must perform initialization process as explained in below steps:

1. Press and hold the reset button, then remove one battery and place it back again, keep holding until the lock prompts "Restore to default settings, wait a moment."
2. And after 10 seconds, the lock will prompt "Complete", which means the initialization process is finished.

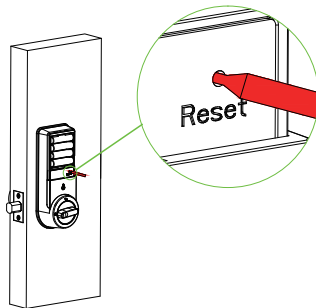

## Mark and drill holes for the strike box and plate.

1

Make sure that the strike box is in level of latch bolt, then use installation template to drill holes.

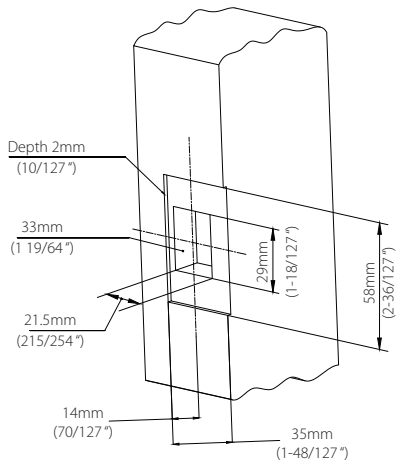

2

Align the strike box and plate with the drilled hole and use screws B to secure them.

