

Quick Start Guide

ProRF

Version: 1.0

Date: August 2018





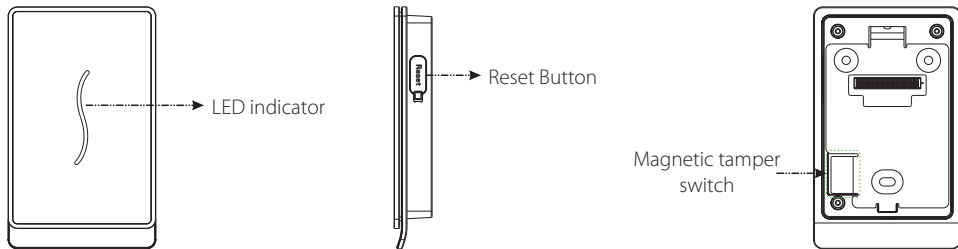





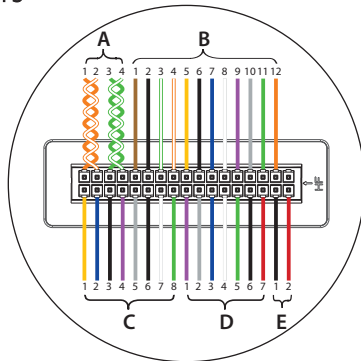
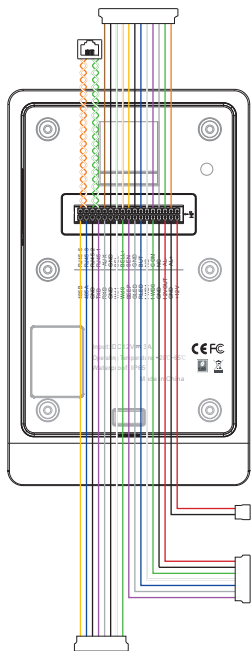

Overview







Name	Description
LED indicator	<ul style="list-style-type: none">• Green flashes once in a second: verifying, enrollment or deletion status.• Green glows continuously for 2 seconds: Authentication success• Red glows continuously for 2 seconds: Authentication failure
Reset	<ul style="list-style-type: none">• Reboot the device: press the reset button and hold it for 3 seconds.
Magnetic Tamper Switch	<ul style="list-style-type: none">• Restore factory setting• Tamper Switch: keep the magnetic tamper switch on back plate, or it will trigger the tamper alarm.

Cables and connectors



PIN	DESCRIPTION	WIRE	
D1	BEEP	Purple	
D2	GLD	Gray	
D3	RLED	Blue	
D4	IWD1	White	
D5	IWD0	Green	
D6	GND	Black	
D7	12VOUT	Red	
E1	GND	Black	
E2	+12V	Red	

PIN	DESCRIPTION	WIRE	
A1	RJ45-6	Orange	
A2	RJ45-3	Orange+White	
A3	RJ45-2	Green	
A4	RJ45-1	Green+White	
B1	AUX	Brown	
B2	GND	Black	
B3	BELL-	Green+White	
B4	BELL+	Orange+White	
B5	SEN	Yellow	
B6	GND	Black	
B7	BUT	Blue	
B8	NO	White	
B9	COM	Purple	
B10	NC	Gray	
B11	AL-	Green	
B12	AL+	Orange	
C1	485B	Yellow	
C2	485A	Blue	
C3	GND	Black	
C4	TXD	Purple	
C5	RXD	Gray	
C6	GND	Black	
C7	WD1	White	
C8	WD0	Green	

Installation

- 1) Paste the mounting template sticker on the wall, and drill holes according to the mounting paper.

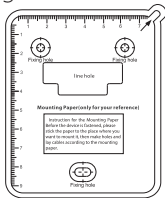

- 3) Attach the device to the back plate.

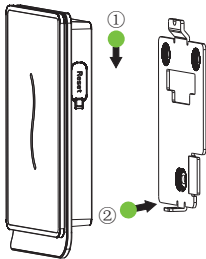

- 2) Fix the back plate on the wall using wall mounting screws.

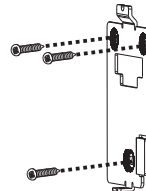

- 4) Fix the device to the back plate with a security screw.



Power Connection

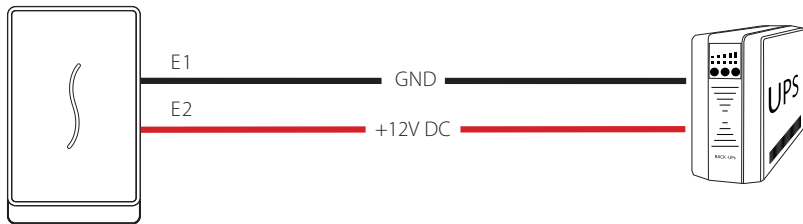
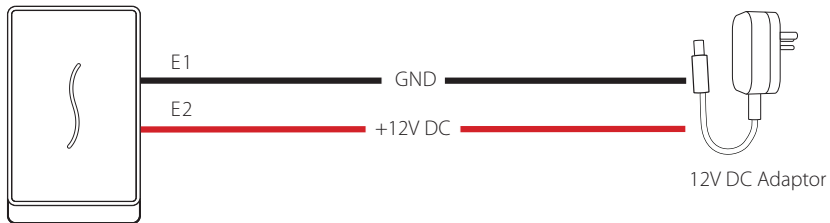

Recommended power supply

1) $12V \pm 10\%$, at least 500mA.

2) To share the power with other devices, use a power supply with higher current ratings.

Ethernet Connection

1) The device connects to the computer over an Ethernet through a switch.

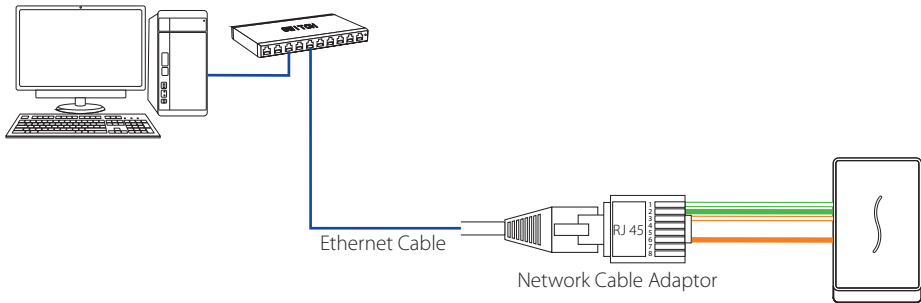

2) The device directly connects to the computer.

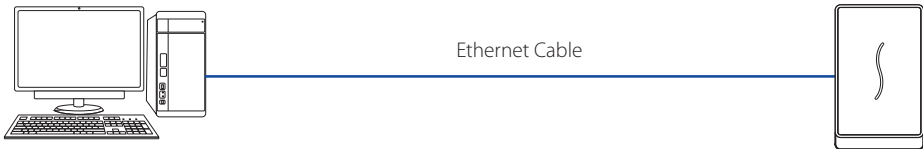

Default IP address: 192.168.1.201
Subnet mask: 255.255.255.0

Lock Relay Connection

The system supports Normally Opened Lock and Normally Closed Lock.
Take Normally Closed Lock as an example below:

❖ Device not sharing power with the lock

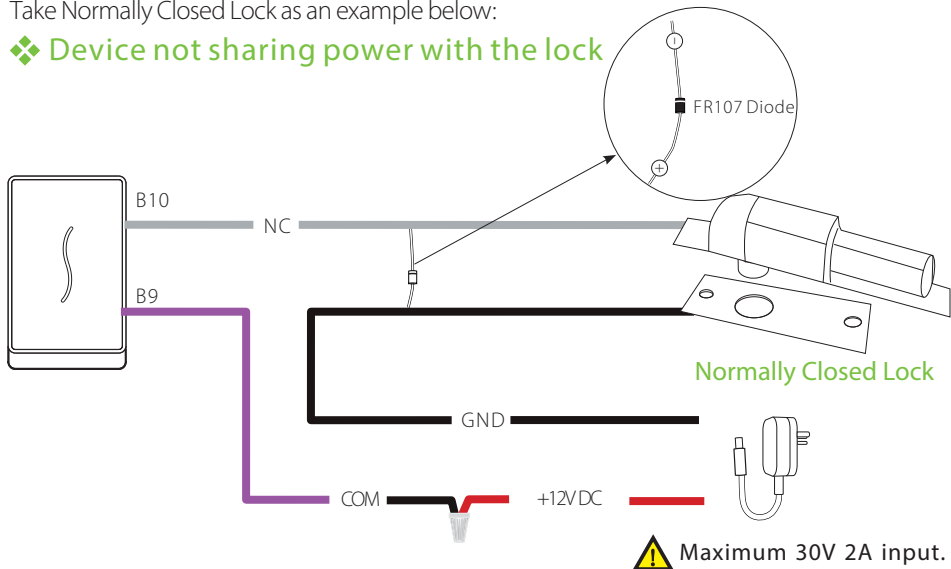

Lock Relay Connection

❖ Device sharing power with the lock

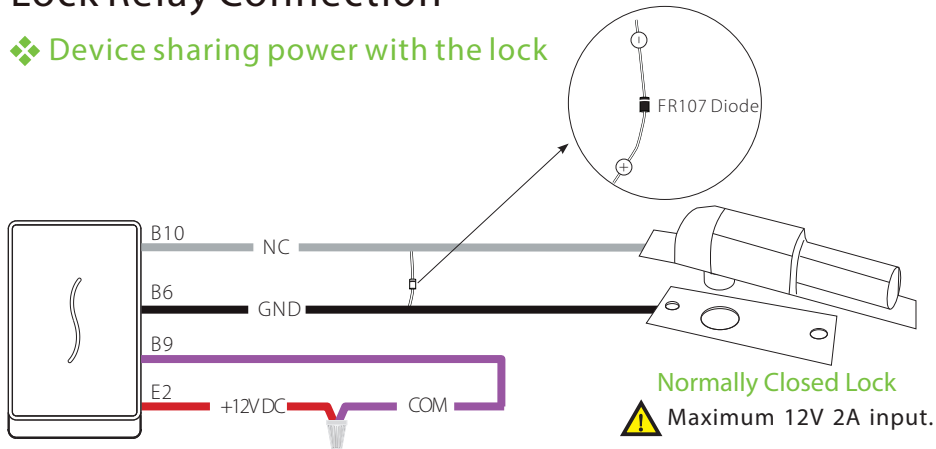

Notes:

1. The system supports Normally Opened Lock and Normally Closed Lock. The NO LOCK (normally opened at power on) is connected with 'NO' and 'COM' terminals, and the NC LOCK (normally closed at power on) is connected with 'NC' and 'COM' terminals.
2. When electrical lock is connected to the Access Control System, you must add one FR107 diode in parallel (equipped in the package) to prevent the self-inductance EMF from affecting the system.

Door Sensor, Exit Button, Bell & Alarm Connection

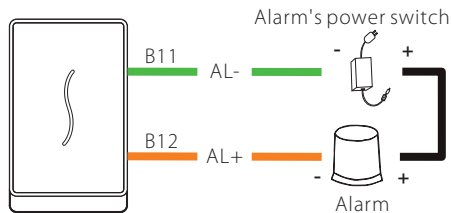
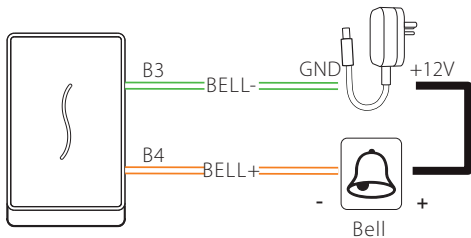
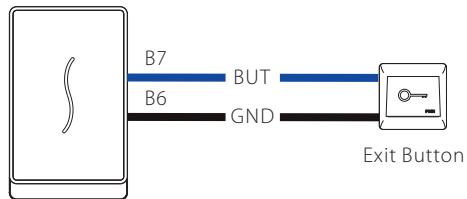
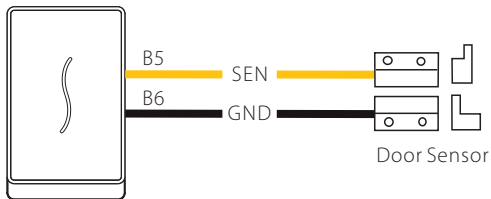

RS485 Connection

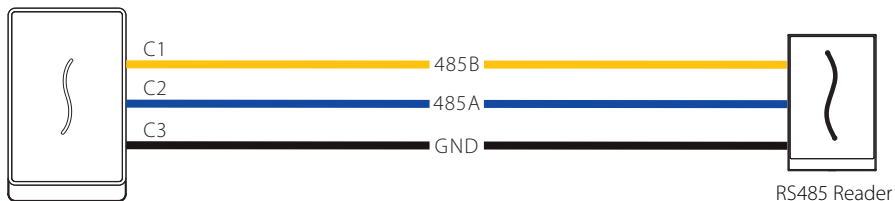

RS232 Connection(optional)

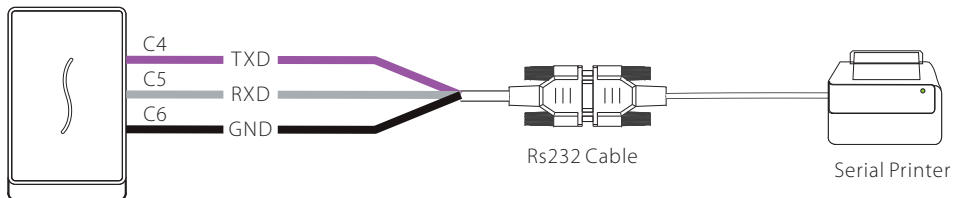

Wiegand Output Connection

After a successful verification, the device will send Wiegand signals to the SRB access controller, then the SRB will output relay signals to trigger the relay to unlock the door.

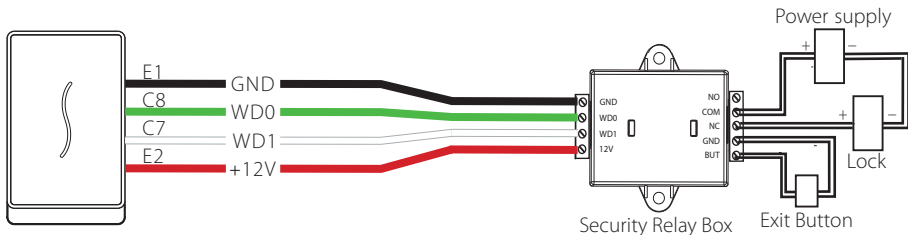

Wiegand Input Connection

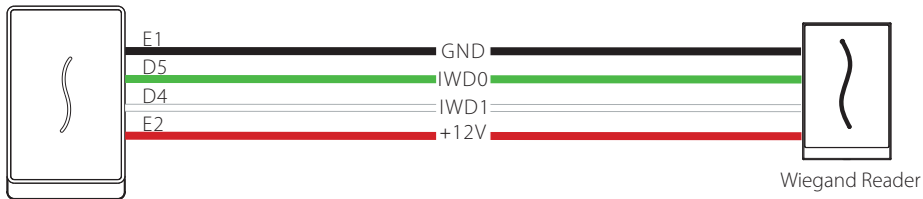

Standalone Installation

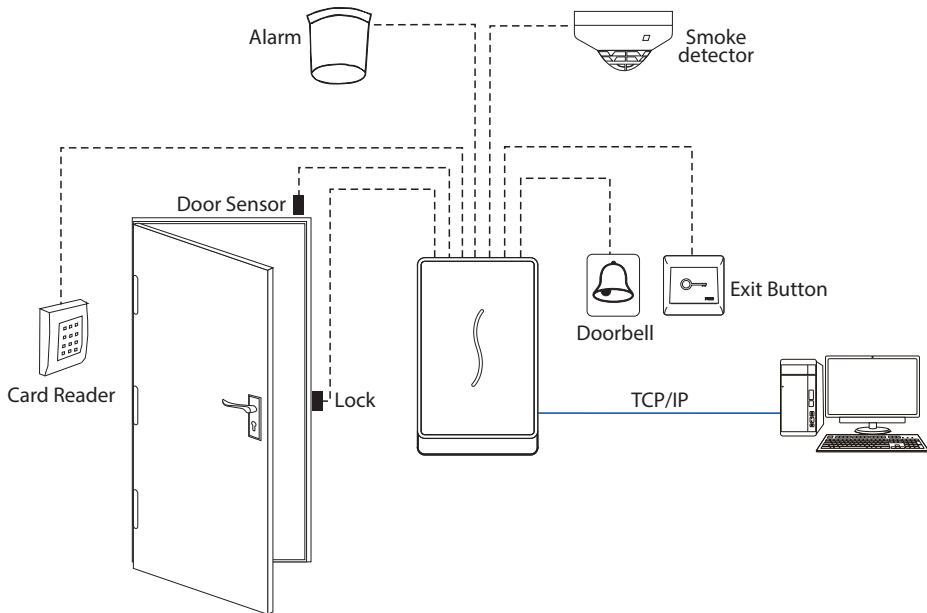

Quick Start Operations

Suppose the device is connected with PC and the software (ZKAccess 3.5) is installed. Double-click the ZKAccess3.5 icon on the desktop to open.

❖ Add Device

Click [Device] > [Device] > [Add], enter device name and IP Address of the device and click [OK]. The following interface will be shown:

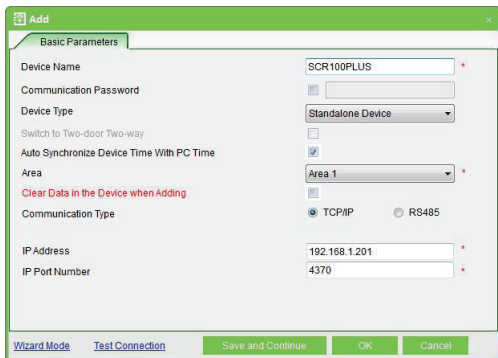

Add

Basic Parameters

Device Name: SCR100PLUS

Communication Password: [Empty]

Device Type: Standalone Device

Switch to Two-door Two-way: [Unchecked]

Auto Synchronize Device Time With PC Time: [Checked]

Area: Area 1

Clear Data in the Device when Adding: [Unchecked]

Communication Type: TCP/IP (Selected), RS485

IP Address: 192.168.1.201

IP Port Number: 4370

Wizard Mode | Test Connection | Save and Continue | OK | Cancel

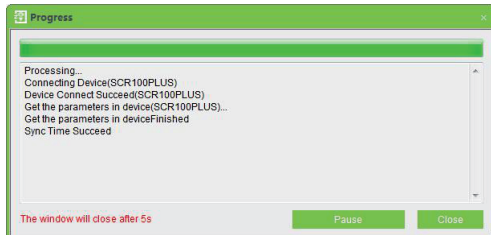

Progress

Processing...

Connecting Device(SCR100PLUS)

Device Connect Succeed(SCR100PLUS)

Get the parameters in device(SCR100PLUS)...

Get the parameters in deviceFinished

Sync Time Succeed

The window will close after 5s

Pause | Close

Note:

1. IP addresses of the server (PC) and the device must be in the same network segment. The default IP Address of the device is 192.168.1.201.
2. Please set the device type to standalone device.
3. Once IP address and communication password missing, please refer Reset function.

❖ Add Personnel

1. Click [Personnel] > [Personnel] > [Add] to add personnel information and set access levels.

The screenshot displays the ZKTeco software interface. The main window has a green header with the ZKTeco logo and a menu bar containing 'Personnel', 'Device', 'Access Control', 'Reports', and 'System'. Below the menu bar is a toolbar with icons for 'Add', 'Edit', 'Delete', 'Search', 'Adjust Department', 'Batch Add Personnel', 'Import', 'Export', and 'Operation Log'. A sidebar on the left lists 'Personnel', 'Department', 'Personnel', and 'Issue Card'. The main content area shows a table with columns for 'Personnel ID', 'First Name', 'Last Name', 'Card Number', 'Department...', 'Department...', 'Gender', '10.0 FP Qty', '9.0 FP Qty', 'Vein Quantity', 'Face Qty', and 'Plam Vein Qty'. A modal dialog box titled 'Add' is open, showing a 'Personnel Profile' form. The form has tabs for 'Personnel Profile', 'Details', and 'Access Levels'. It contains the following fields: Personnel ID (text), Department (dropdown), First Name (text), Card Number (text), Last Name (text), Mobile Phone (text), Gender (dropdown set to 'Male'), Hired Date (calendar), Password (text), Birthday (calendar), Email (text), Privilege (dropdown set to 'Personnel'), and Fingerprint Reg. (radio buttons for 'USB FP Sensor', 'USB Finger Vein sensor', and 'Device'). There is a photo upload section with a placeholder image and 'Browse' and 'Shoot' buttons. At the bottom of the dialog are 'Save and Continue', 'OK', and 'Cancel' buttons. The background shows a status bar with several numerical indicators.

❖ Access Control Setting

User can set Access Control Time Zones, Access Control Holiday, Door Settings, Access Levels, Personnel Access Levels and so on in Access Control interface. For more details, please refer the user manual and the software instruction.

❖ Sync All Data to Device

The system will synchronize the data to the device, including door information, access control levels (personnel information, access control time zones), and so on. Select device, click [Synchronize All Data] and click [OK] to complete synchronization.

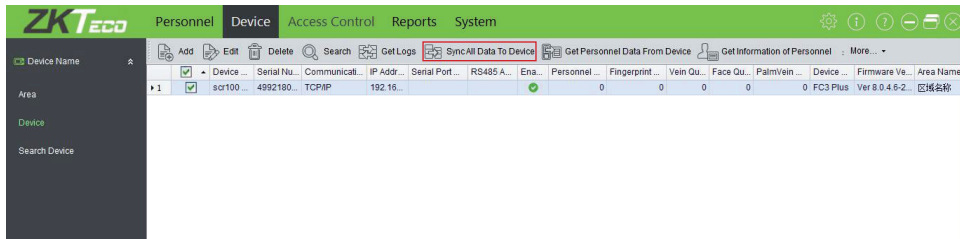

The screenshot displays the ZKTeco software interface. The top navigation bar includes 'Personnel', 'Device', 'Access Control', 'Reports', and 'System'. The 'Device' tab is active. The main toolbar contains buttons for 'Add', 'Edit', 'Delete', 'Search', 'Get Logs', 'Sync All Data To Device' (highlighted with a red box), 'Get Personnel Data From Device', and 'Get Information of Personnel'. Below the toolbar is a table with columns: Device Name, Area, Device, Search Device, Device, Serial Nu..., Communicati..., IP Addr..., Serial Port..., RS485 A..., Ena..., Personnel ..., Fingerprint ..., Vein Qu..., Face Qu..., PalmVein ..., Device ..., Firmware Ve..., and Area Name. The first row of the table shows a device with ID '1', name 'scf100', serial number '4992180', communication 'TCP/IP', IP address '192.16...', and a green status indicator.

Device Name	Area	Device	Search Device	Device	Serial Nu...	Communicati...	IP Addr...	Serial Port...	RS485 A...	Ena...	Personnel ...	Fingerprint ...	Vein Qu...	Face Qu...	PalmVein ...	Device ...	Firmware Ve...	Area Name
1		scf100		4992180	TCP/IP	192.16...				●	0	0	0	0	0	FC3 Plus	Ver 8.0.4.6-2...	区域名称

❖ Tips

Forgot the password/IP address?

Trigger the magnetic tamper switch three times quickly within 30-60 seconds of the device start-up. (The LED indicator turns yellow.)

This process restores factory settings, such as device password, IP address, etc.

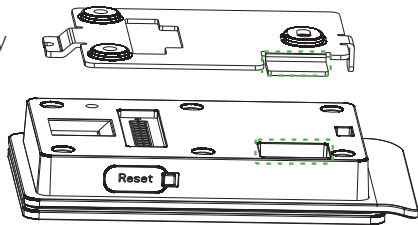

Green
Label

ZK Building, Wuhe Road, Gangtou, Bantian, Buji Town,
Longgang District, Shenzhen China 518129

Tel: +86 755-89602345

Fax: +86 755-89602394

www.zkteco.com

