

User Manual

Video Door Phone System
VDPI-B1

Version:2018

COLOR VIDEO DOOR PHONE(VDPI-B1)

USER MANUAL

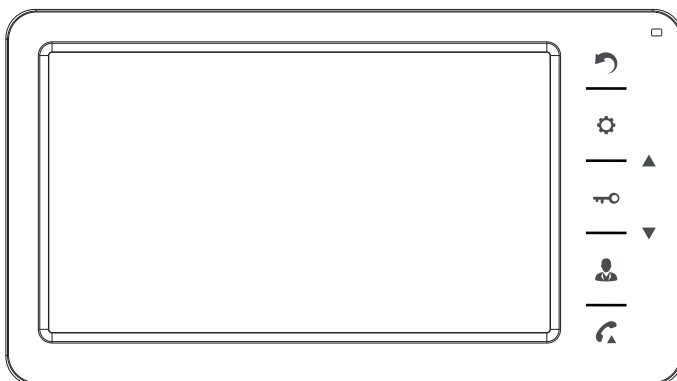

-
- Thank you for purchasing our products.
 - Carefully read this User's Guide(in particular, precautions for safety) before using a product.
 - This product is subject to change without prior notice.
 - The company is not responsible for any safety accidents caused by abnormal operation of the product.

Index

1、Warning and Caution	1
2、The function and name of each part	3
3、Terminal wiring diagram	4
4、Features and main function	4
5、Package contents	5
6、System layout	5
7、Wiring diagram	6
8、Installation method	7
9、Cable specification	8
10、Functions in common use	9
11、System main menu	13
12、Specification	14

1、Warning and caution

◎ Make sure to follow the instructions to prevent any danger or property losses.



Warning

Death or serious injury is expected.



It indicates prohibition.



It indicates disassembly.



It indicates prohibition of contact.



It indicates dos and don'ts.



It indicates that the plug should be pulled out from the socket.

warning

<p style="text-align: right;">NO</p>	<p style="text-align: right;">NO</p>	<p style="text-align: right;">NO</p>
<p>Do not put the plug in the socket simultaneously. It may generate abnormal heat or cause a fire.</p>	<p>Do not connect to other products while in use. It may cause breakdown.</p>	<p>Do not forcibly bend the cord or put a heavy object on the product. It may cause a fire.</p>
<p style="text-align: right;">NO</p>	<p style="text-align: right;">NO</p>	<p style="text-align: right;">NO</p>
<p>Do not use water, thinner or a detergent used to wash oil products when you wash the exterior. Make sure to wash it by using a dry cloth to prevent any breakdown or electric shock.</p>	<p>Do not install the product in a humid place. It may cause an electric shock or a fire.</p>	<p>Do not forcibly pull out the cord from the socket. If the cord is damaged, it may cause a fire or an electric shock.</p>
<p style="text-align: right;">NO</p>	<p style="text-align: right;">NO</p>	<p style="text-align: right;">!</p>
<p>Do not put the plug in the socket with a wet hand. It may cause an electric shock.</p>	<p>Do not disassemble, repair or modify the product. It may cause a fire, an electric shock or an injury due to malfunction of the product.</p>	<p>Do not use AC circuit breaker. It may cause an electric shock.</p>



Caution

A injury or property losses are expected.



It indicates prohibition.



It indicates disassembly.



It indicates prohibition of contact.



It indicates dos and don'ts.



It indicates that the plug should be pulled out from the socket.



<p style="text-align: right;">NO</p>	<p style="text-align: right;">NO</p>	<p style="text-align: right;">NO</p>
<p>If the socket holes are larger than normal, do not put the plug. It may cause an electric shock or a fire.</p>	<p>Make sure that dust or foreign substances are not gathered on the product.</p>	<p>Make sure to prevent foreign substances from entering the product. It may cause a breakdown.</p>
<p style="text-align: right;">!</p>	<p style="text-align: right;">NO</p>	<p style="text-align: right;">!</p>
<p>Do not put a heavy object on the product. It may cause a breakdown.</p>	<p>Do not disassemble or give an impact to the product.</p>	<p>Avoid direct rays of the sun or heating devices at a time of installation.</p>
<p style="text-align: right;">!</p>	<p style="text-align: right;">!</p>	<p style="text-align: right;">!</p>
<p>Install the product in a flat and stable place. Otherwise, it may not function properly.</p>	<p>Pull the plug if the product is not used for a long time.</p>	<p>If the product generates strange sound, make sure to pull the plug immediately and contact service center.</p>

2、 The function and name of each part

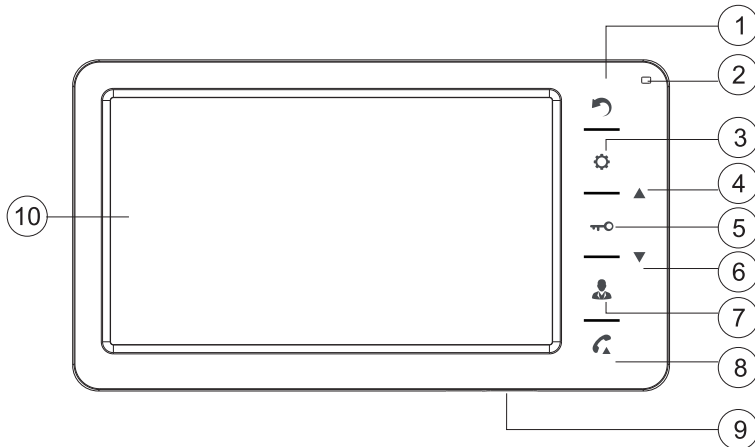

- 1). Return button: Return/hang up
- 2). Indicator light: Power indicator light
- 3). Menu button: Enter system menu/Confirm
- 4). Navigation button Up: Choose/Adjust
- 5). Unlock button: Unlock
- 6). Navigation button down: Choose/ Adjust
- 7). Monitor button: Monitor
- 8). Answer button: Answer/Call
- 9). Power on/off
- 10). LCD

3、 Terminal wiring diagram

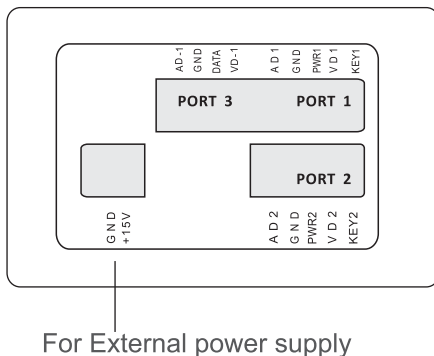
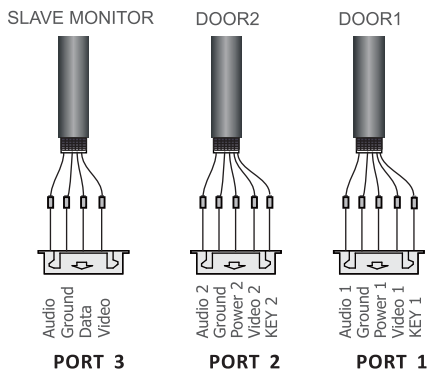

4、 Features and main function

1).Features

- 7" color screen
- Hands free design
- Comfortable touch button
- OSD menu with various setting
- 12 chord call melodies
- Easy to install and operate

2).Main functions

- Lock control
- Brightness, contrast, talk volume, color and display mode adjustable.
- Real-time monitoring of door station or CCTV camera
- “Do not disturb” function
- Broadcast and intercom call to other monitors
- Monitor listening to other indoor monitors
- Call transfer to other indoor monitors

5、 Package contents

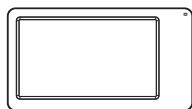

Monitor



User manual

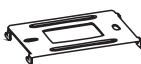

Wall bracket



2*Expansion bolt



Desiccant



2*M5*30
fixing screws



2x5 pin connector
(red/blue/yellow/
white/brown)



4 pin connector
(red/blue/yellow/
white)



4 pin connector
(white/blue/
white/blue)



Adaptor

6、 System layout

The port 2 connect to door station

The system can support maximum 1 master monitor, 3 sub monitors, 2 door stations.

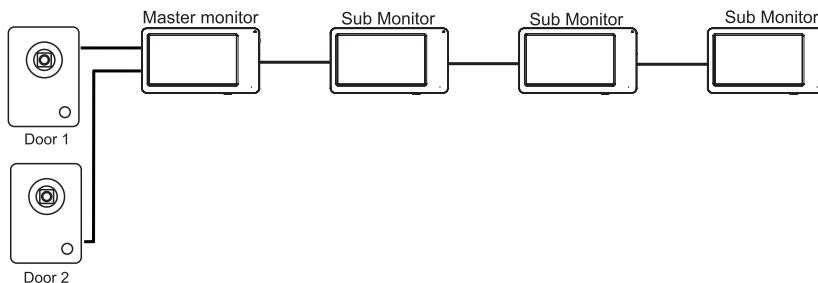

7、Wiring diagram

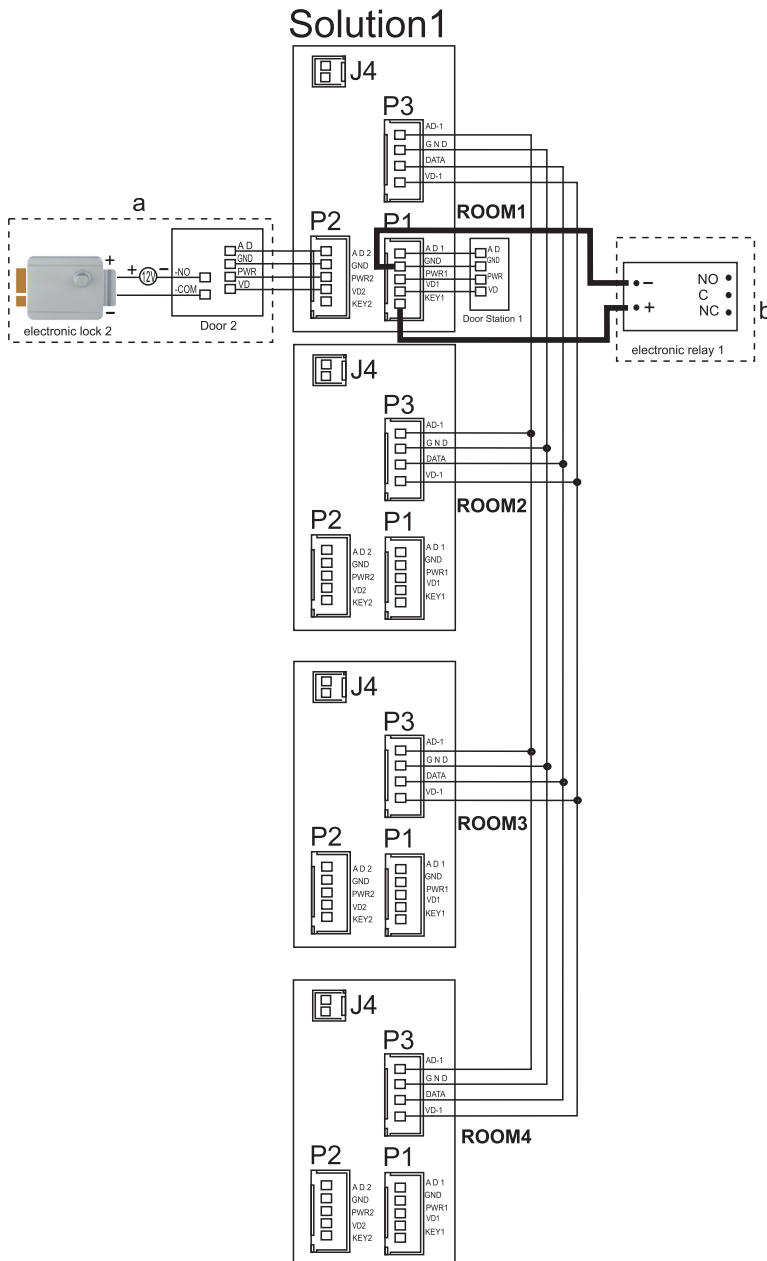

Note: (a)Door station unlock wiring: electronic lock 2+external power supply.
 (b)Indoor monitor unlock wiring: electronic relay 1 to KEY1 and GND.
 (c)J4 port is for external power.

8、Installation method

1. Refer to relevant wiring diagram for the system you have chosen and ensure you have the correct cable.
2. Determine the monitor installation position:
-suggest to install at 1.5~1.6Meters;
3. Ensure no power supply connection before installation finished
4. Install the bracket on the wall
5. Connect cables as per the wiring diagram indicated.
6. Fix the monitor onto the bracket.
7. Connect power when doorbell is installed.

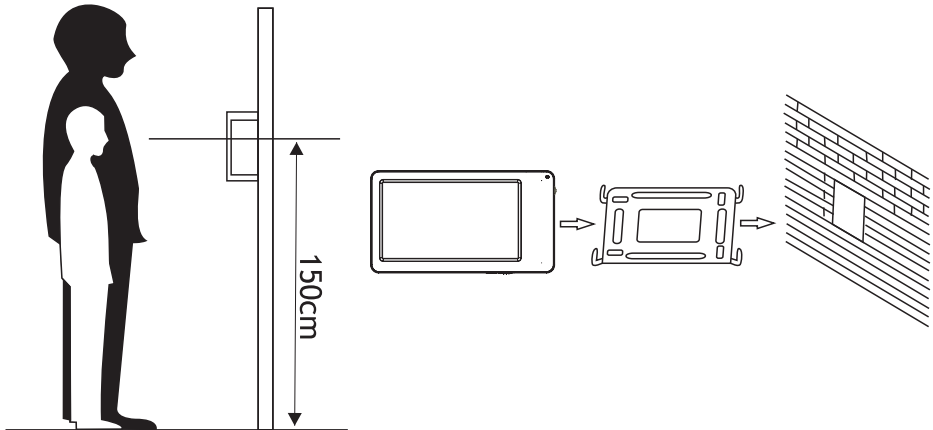

9、Cable specification

Our system has 2 solutions to unlock the door: Unlock signal from door station or unlock signal from monitor.(The cable shield wire needs to be grounded)

Cable specification is:

- Distance between monitor and door station is less than 30 meters, shielded 4 x 0.5mm² cable is OK;

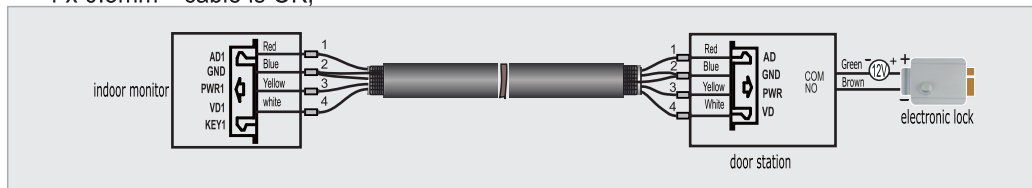

- Distance exceed 30 meters, please choose coaxial cable for video with another shielded 2*0.5mm² cable or composite coaxial cable.

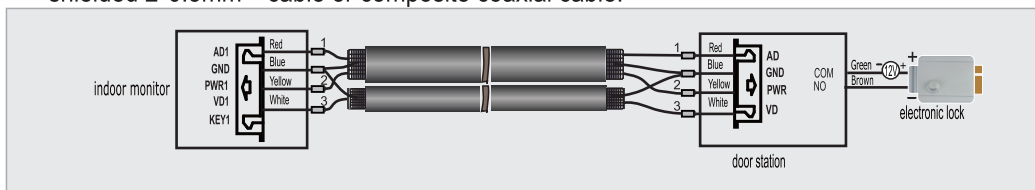



- When using KEY wire from monitor to unlock please use electronic relay as shown on Page 6.

10、 Functions in common use

1). How to answer the call and transfer the call to other indoor monitors



When call from door station or other indoor monitor, the indoor monitor(s) will chime, short press  to answer the call. If no one answers, the monitor(s) shall be back to standby status after chime time end.

When the monitor is chiming, or when talk with visitor, short press  can unlock the door.



When talking with one door station, if some one calls at the other door station, the screen will show relevant indication, short press  can switch to talk with the other visitor.



When at talking status, short press  can transfer the call to other indoor monitors.

When at talking status, short press  will switch the screen to other video channel and keep monitoring status; while back to the previous video channel, the device will be back to talk status.

When at talking status, long press , the microphone will be disabled, long press  again can enable the microphone, screen will show relevant indication when doing the above operations. The above operation is only valid in the present calling, the microphone shall be enabled automatically after the call ends.

2). How to use monitoring function

At standby status, short press  to monitor Door 1, short press  again can switch to another video channel. When monitoring door station channel, short press  can talk to door station.

When talk with door station, short press  can unlock the door. If enable MONITOR UNLOCK function in advanced setting, user can short press  to unlock the door when monitoring door station.

If at CCTV status, the longest monitoring time is 4 hours.

3). How to make internal call



At standby status, user can short press  to enter intercom call interface, then short press  to choose call target, press  to confirm calling.

For indoor monitors installed in multi-apartment system, user can input target room no. then start calling. "0" is the address no. for management center.

4). How to make broadcast(handset model does not have this function)

At standby status, user can long press  to enter broadcast status directly. It shall broadcast to all indoor monitors in the system and could not choose broadcast target.

5). How to use the monitor listening function



At standby status, long press  to enter the monitor listening interface, then press  to choose the monitor listening target, press  to confirm monitor listening.

The maximum monitor listening time is 8 hours.

Attention:

- a. At monitor listening status, you can hear the voice from the opposite side, but they can't hear your voice.
- b. At broadcasting status, your voice can be heard by the opposite side, but you can't hear the voice from them
- c. There must be at least 2 monitors in the system for functions 3), 4) and 5)..

6). How to adjust the Volume, Brightness, Chrominance, contrast ratio and display scale.

At video display or audio play interface, user can short press  or  to adjust the volume or brightness.

At video display status, when adjust volume/brightness interface, short press  can switch to adjust other parameters interface: Volume, Brightness, Chrominance, contrast ratio & display scale.

7). How to set the address of indoor monitor.

The default address is Room1. Optional Room1~Room4. The master monitor which connects to door station directly, should be set as Room1. If the system has 2 or more than 2 indoor monitors, can't set a same address in 2 monitors, or the system can't work normally & that option will caution in red color.



8). How to enter system setting?

At standby status, users can long press  to enter system settings menu.

9).“Don't disturb” function

You can use SYSTEM SETTINGS menu to turn “DO NOT DISTURB” function on or off. When turn on this function, the indoor monitor shall not chime when someone calls to it.

10). How to enter advanced settings?

In the models that are not installed in a multi-apartment system, users can enter advanced setting by restarting the monitor, and long press  at welcome screen. In the models that are connected in a multi-apartment system, there isn't a welcome screen after restarting monitor. The indicator shall flicker a few times after restarting the monitor, long press , then the monitor shall enter advanced settings menu.

ADVANCED SETTING	
NOV 12 2014	10:10:22
VCOMDC	140
UNLOCK TIME	01S
MONITOR UNLOCK	ENABLE

(A). VCOMDC: It's for adjusting the sharpness of the LCD. The factory has set a most suitable value before the products leaving the factory. Please do not change it casually, or the screen may not display normally.

(B). UNLOCK TIME: It can be set from 1S to 10S. Note: most electric locks only need 1 second unlocking time, please do not change it if there's no such needs for your lock, because too long time unlock power might cause damage to your lock.

(C). MONITOR UNLOCK: If turn this function on, the door will be open by pressing unlock button at monitoring state or intercom/talking state. If turn it off, the door can only be open at intercom/ talking state by pressing unlock button.

Note: As some of the advanced setting may bring security risk, please do not change it randomly.

11、System setting

In standby status ,press  button to enter system setting menu.

No.	Setting items	Options	Notes
1	CHIME TIME	Default 30seconds (10to 60seconds adjustable)	
2	CHIME VOLUME	Default 07, 0 1 to10adjustable.	
3	CHIME TYPE	Door1 Chime type	01 by default, 00-11 optionals
		Door2 Chime type	02 by default , 00-11 optionals
		Intercom chime type	03 by default , 00-11 optionals
4	NO DISTURB	Off by default, at the ringing, intercom between monitors, broadcast status, the LED indicator will flicker when turn on “DO NOTDISTURB” function.	
5	BE MONITORED	Off by default, it can be monitored by other indoor intercoms in the system when turn on this function.	
6	MONITOR UNLOCK	Press  button to unlock	
7	DEVICE ADDRESS	Room1/2/3/ 4	Master monitor must be set as ROOM 1, and the option will be yellow if two monitors set the same address.
8	DEV INFO	DEVICE NAME/VENDOR/MANU TIME	
9	RESTORE DEFAULT	Restore the system to default settings.	

12、Specification

NO.	Items	Content
1	Power supply	AC100-240V 50/60Hz DC 15V 1A(External)
2	Power consumption	7W(Max). 0.7W(Standby)
3	Operation temperature	0°C to +40°C
4	Operation humidity	0%–95%
5	LCD size	7 inch
6	Intercom mode	Hands-free
7	Connection	4 wires
8	Dimension	210*116*25mm
9	Weight	430g

ZK Building,Wuhe Road,Gangtou,Bantian,Buji Town,
Longgang District,Shenzhen China 518129

Tel:+86 755-89602345

Fax:+86 755-89602394

www.zkteco.com

