

1. Cautions

Please note the following cautions. Mis-operation may lead to personal injury or equipment failure:

- 1) Do not energize the system before installation is complete; never carry out installation activities when the system is energized. Check the correctness of cable connection before you energize the system.
- 2) All peripheral devices must be grounded.
- 3) The conduits of wires under relay must be matched with metaled conduits, other wires can use PVC conduits.
- 4) It is strongly recommended that the length of exposed part of any connection cable should not be longer than 4 mm. Professional clamping tools may be used to avoid unintentional contact of exposed wires to avoid short-circuit or communication failure.
- 5) It is recommended that the control panel be installed at height of 2m above ground, card readers and buttons be installed at height of 1.4m-1.5m above ground.
- 6) It is not recommended that the electrical lock and control panel use the same power supply. It is recommended that the control panel use the provided access control power supply or PoE, and the electrical lock use an external power supply separately.

Description of normal working state:

Connect the system to the power supply. If the system works properly, the POWER indicator (red) is lit constantly and the RUN indicator (green) flashes. If the system is communicating, the COMM indicator (yellow) flashes.

2. Components

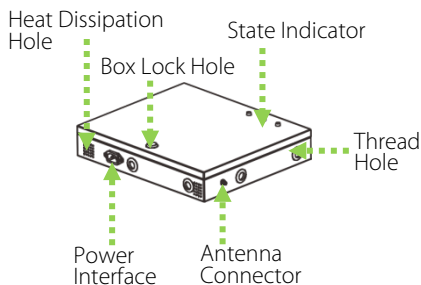

Panel Box Appearance

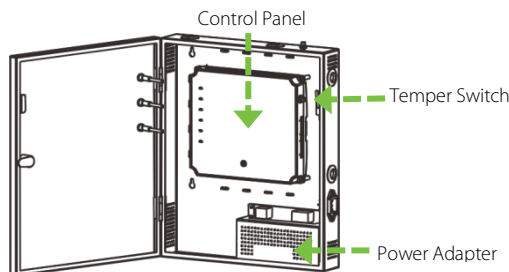

Panel Box Inside

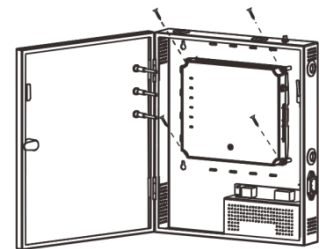

Get the Panel off the track (Remove the set screws)

3. Installation

If the provided chassis is used, the control panel has been installed inside the chassis by default. Fix the chassis on the wall, remove the hole plug or get through the thread hole, connect the access control cable, and install other components.

Remarks: The control panel has a guide rail on the back. If you need to install the control panel separately without the chassis, you can use the guide rail to fix the control panel. The following figures show how to fix the control panel using the guide rail.

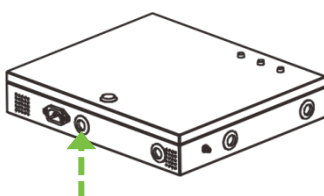

Thread Hole

1) Remove the hole plug or get through the thread hole

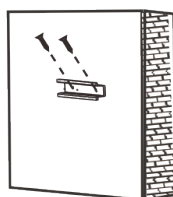

2) Fix the guide rail on the wall

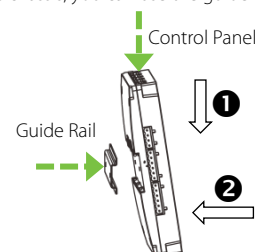

3) Install other components

4. LED Indicators and Wire Illustration

1) Meaning of LED indicators:

POWER indicator (red): light always indicates control panel is power on. RUN indicator (green): flashing indicates the system works normally.

COMM1 indicator (yellow): flashing indicates the system is communicating with upper-level devices (for example, the PC).

COMM2 (yellow): flashing indicates the system is communicating with lower-level devices (for example, readers).

WLAN indicator (green): flashing indicates the system is communicating in wireless (WIFI) mode.

DOOR indicator (green): flashing indicates a door opening signal (a door is opened).

2) Recommended use of wires:

Interface	Wire Specification	Network cable	Maximum length
Power (A)	18AWG*2PIN	/	1.5M
Wiegand (B)	24AWG*6PIN (6PIN, 8PIN, 10PIN for different readers)	CAT-5 or above network cable, one way DC impedance less than 100Ω/KM	100M
Electric Lock (C)	18AWG*2PIN+24AWG*2PIN. 18AWG*2PIN for lock connection, 24AWG*2PIN for door sensor connection.	/	50M
Button (D)	24AWG*2PIN	/	100M
EXT RS485 (E)	20AWG*2PIN+24AWG*2PIN, 20AWG*2PIN for reader power supply, 24AWG*2PIN for RS485 communication	CAT-5 or above network cable, one way DC impedance less than 100Ω/KM. In wire connection, +12V and GND of power supply need to be parallel and use double wires.	Share power with control panel: 100M Use independence power supply (connect RS485 signal interface only): 1000M

3) The auxiliary input may be connected to infrared body detectors, fire alarms, or smoke detectors. The auxiliary output may be connected to alarms, cameras or door bells, etc.

4) State Indicators are connected to the chassis, with is power indicator, run status indicator and communication status indicator.

5) PC RS485 indicates the RS485 cable is connected to the PC through this port. The EXT RS485 port can be connected externally to RS485 reader.

6) The USB slot is primarily used for control panel upgrade. For details, see the user manual.

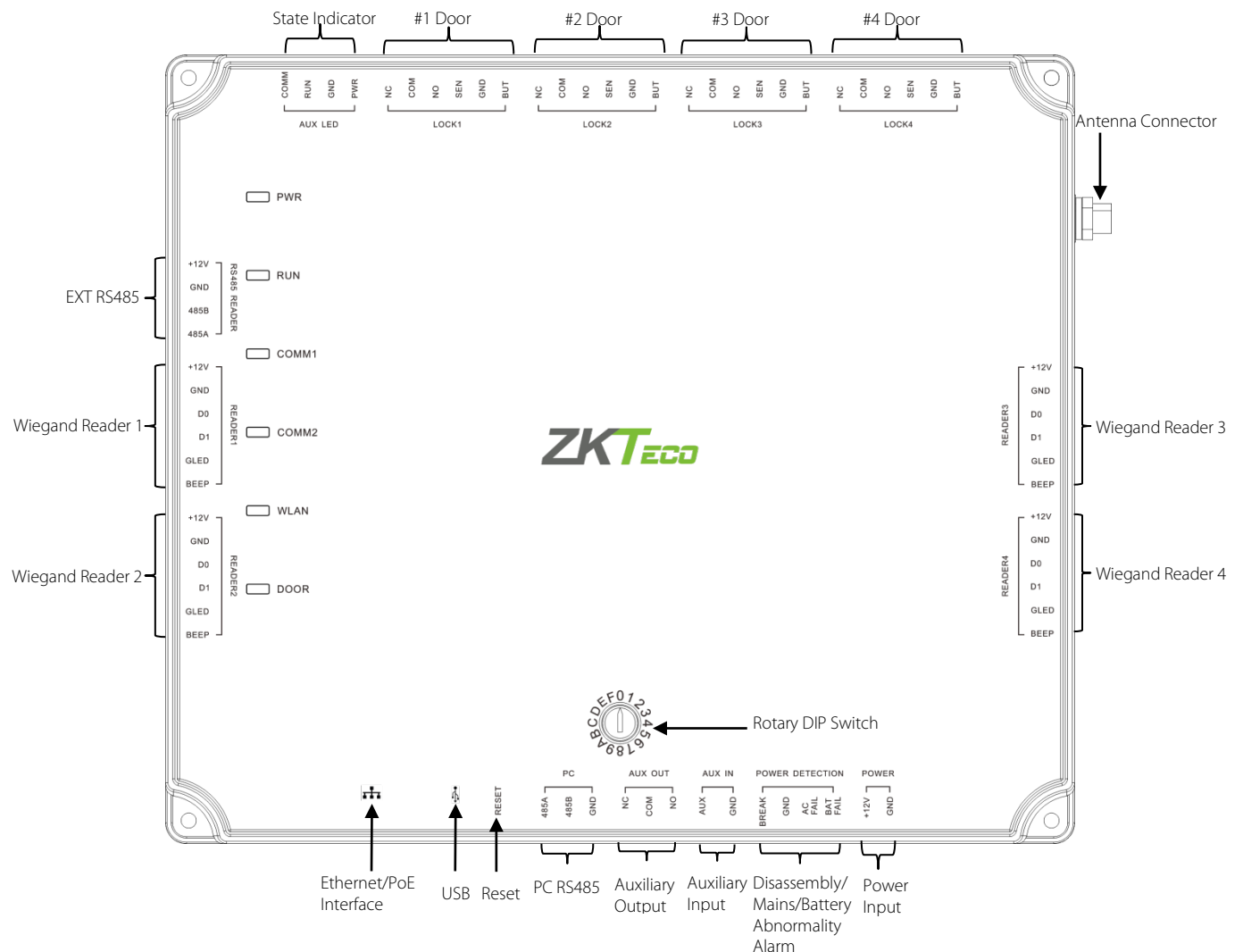

5. DIP Switch Settings

The 0–F bits of the rotary DIP switch indicate device numbers 1–16 during RS485 communication. (Switch 0 indicates device number 16, switch 1 indicates device number 1, and so on. Switch F indicates device number 15). You can rotate the 0–F bits of the rotary DIP switch to corresponding positions to set device numbers, and then restart the control panel to make the setting take effect. Address numbers cannot be repetitive.

6. Connection Of Lock

- 1) Control panel provides lock control output interfaces. For NO lock, it is open when power is on, and closed when power is off, so COM and NO interfaces should be used. For NC lock, it is open when power is off, and closed when power is on, so COM and NC interfaces should be used.
- 2) The default connection mode of the door lock is “dry mode”. Specifically, the electrical lock uses an external power supply separately, rather than share the power supply for the control panel.
- 3) Our access controller is powered by standard PoE or access control power. You can choose either of the two power supplies as needed. The two power supplies provide 12V/3A power for only the power consumption of the control panel, Wiegand readers, and output power consumption of RS485 reader.
- 4) When the Electrical Lock is connected to the Access Control System, you need to parallel one FR107 diode (equipped in the package) to prevent the self-inductance EMF affecting the system, do not reverse the polarities.
- 5) The following figure shows the default lock connection mode.

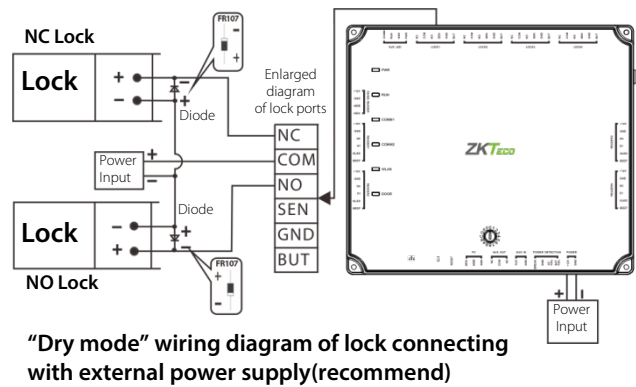

7. RS485 Reader Connection

The control panel supports RS485 reader and Wiegand reader (Note: The control panel does not support fingerprint verification of RS485 reader). RS485 reader connection: First of all, set the RS485 address (device number) of the reader by DIP switch or other ways. The RS485 address 1, 2, 3, 4 is for Door 1-4 IN reader, RS485 address 5, 6, 7, 8 is for Door 1-4 OUT reader, as in the figure below.

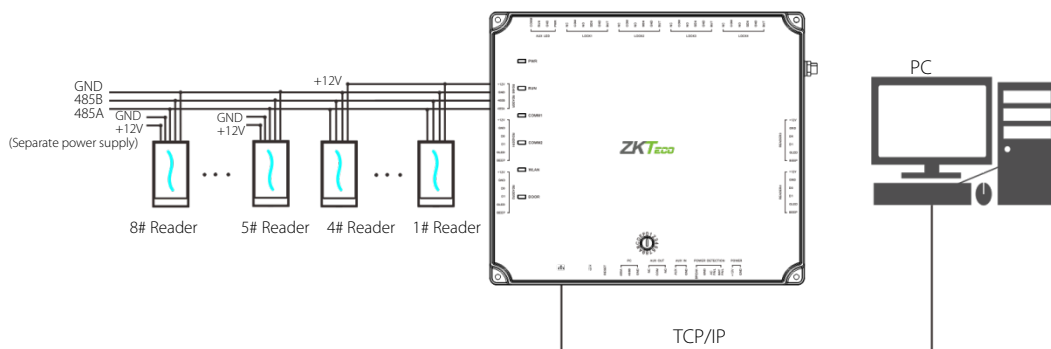

Besides, a single EXT RS485 interface can supply maximum 750 mA (12V) current. So the entire current consumption should be less than this max value when the readers share power with the panel. In calculation, please use max current of the reader, and start current is usually more than twice of the normal work current, please consider of this situation.

For example, use the KR502M-RS card reader, the standby current is less than 80mA, the max current is less than 90mA, When the device is start, Instantaneous current can reach 180 mA. As RS485 reader, consider the starting current is bigger, through the EXT RS485 interface can only connect four readers for power supply. So the power of control panel connect only nearest 4 readers.

If RS485 reader is connected externally and shares the power supply for the device, it is recommended that the connection between the EXT RS485 port and the reader be no longer than 100m. Otherwise, it is recommended that the reader use a separate power supply.

For some of the devices with much greater consumption, we suggest to using the separately power supplies, to make sure the steady operation.

8. Equipment Communication

The background PC software is able to communicate with the system according to three protocols (TCP/IP, RS485 and WIFI (optional)) for data exchange and remote management. The communication cable should be as far away from high-voltage lines as possible. Do not keep the communication cable in parallel with power cords or bind them together.

8.1 TCP/IP Communication

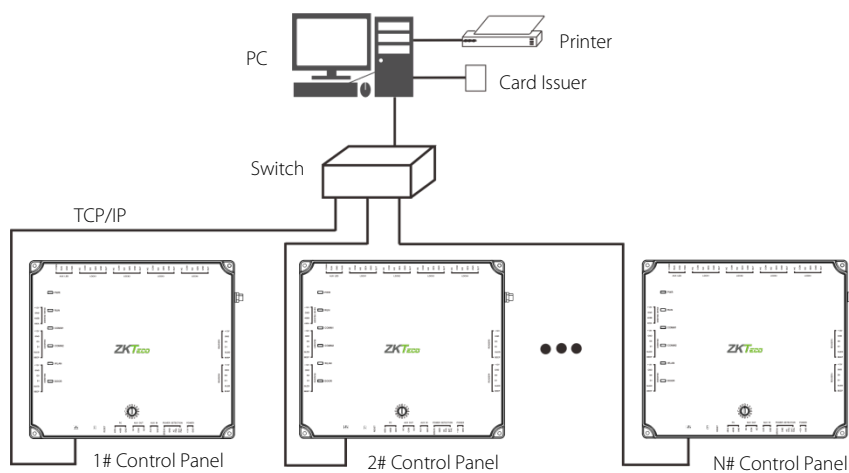

For ZKAccess3.5 software: Click [Device] > [Device] > [Add], also you can click [Device] > [Search Device] to search devices which in the network, and directly add from the searching result.

8.2 RS485 Communication

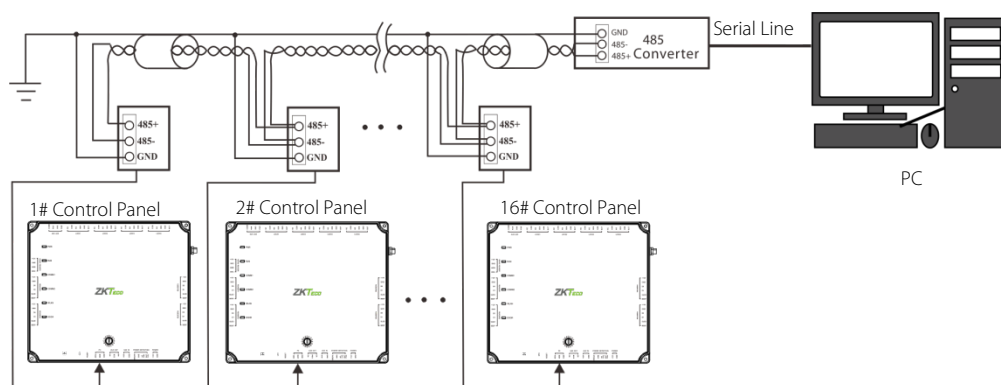

- 1) Internationally accepted RWSP (shielded twisted-pair) wires should be used for communication to effectively avoid interference.
- 2) RS485 communication wires should be connected by means of bus cascade connection.
- 3) Considering stability of communication, it is recommended the length of RS485 bus is less than 600m.
- 4) Up to 16 device numbers can be set because the rotary DIP switch on the control panel has 16 bits. Therefore, a single RS485 bus can be connected to 16 access control panels at most.
- 5) To enhance the stability of communication when the bus is longer than 300m, connect the provided 120-ohm terminal resistor between the 485A and 485B wires of the first and last control panels respectively.

8.3 Wireless Communication

- 1) Create a valid connection string using TCP/IP, and make sure that there is available WiFi network.
- 2) Input the IP address of the controller (factory default is 192.168.1.201) in the address bar; enter the user name and password (both are **admin**), and click [Sign In] to access the ZKPanelWeb.



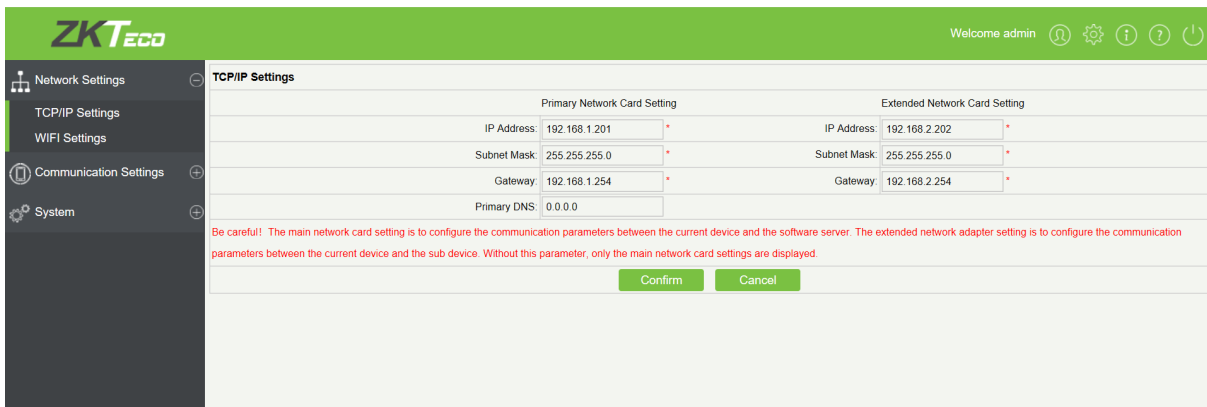

Note:

1. Must configure IP address of the controller and Server (PC) in the same network segment
2. When the controller's IP address is unknown, you can obtain the IP through searching device in the software.
- 3) Click [TCP/IP Settings] to modify the IP address and gateway address; Extended Network Card Setting is set when the controller is connected to TCP/IP reader. For detailed setting methods, please refer to the instructions of TCP/IP reader.

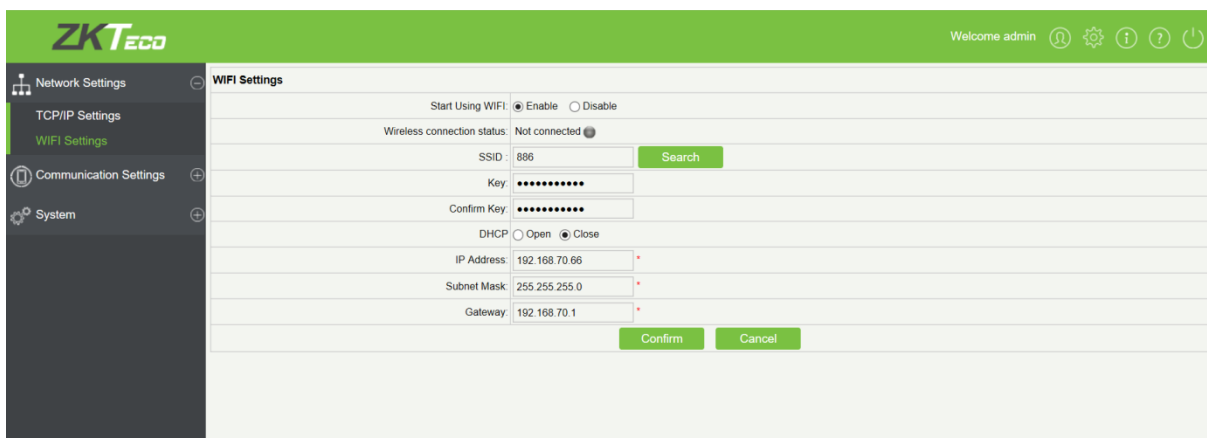

- 4) Click [WIFI Settings] > [Search] to search the available WiFi.



- 5) Select available WiFi in the wireless network list and click [Action] (Figure 1), enter the key, and configure DHCP (the IP address and gateway must be in the same network segment as the wireless network IP address), and then click [Confirm]. After the connection is successful, the wireless connection status shows connected  (as shown in Figure 2), and the device's WLAN indicator turns green.

Action	SSID	Certification	Signal Strength
Action	Tenda	undefined	Low

figure 1

figure 2

Note: The PC (server) must be on the same network segment as the router (wireless network).

6) Switch network connection in the software.

For ZKAccess3.5 software: Select the added C5S control panel on the Device page and click [More...] > [Set up WiFi], as figure 3, set the WiFi parameters of the control panel based on the router parameters. Restart the control panel to make the WiFi settings take effect.

Device Name	Device Na...	Serial Number	Comm...	IP Address	Seria...	RS485 A...	En...	Pers...	Fing...	Vein Q...	Face...
1	192.168.1...	DDG70920170929...	TCP/IP	192.168.1...			✓	0	0	0	0
2	192.168.5...	6403152601516	TCP/IP	192.168.5...			✓	5	0	0	0

figure 3

Note: You must add the C5S control panel to the software through TCP/IP before setting WiFi parameters. Connection through RS485 is not allowed. Of the devices added to the software, only the C5S control panel supports WiFi setting. For details about how to add devices and set WiFi, see the software instructions.