

USER MANUAL

C5S110&120&140

Version: 1.1

Date: Apr., 2018

About This Manual

This manual introduces C5S110/120/140 access control panel installation connection and user instructions.

Contents

1 Safety Instructions	1
1.1 Important Security Instructions	1
1.2 Installation Cautions	3
2 System Introduction	4
2.1 System Function Parameters	4
2.2 Product Technical Parameters	4
2.3 Control Panel Indicators	4
3 Installation and Connection	6
3.1 Chassis Installation	6
3.2 Installation of Access Control Panel Wires	7
3.3 Control Panel System Installation	8
3.4 Control Panel Connection Terminals	9
3.5 Connection with Door Sensors, Exit Switches, and Auxiliary Input Devices	12
3.6 Connection with Readers	13
3.7 Relay Output Connection	15
3.8 Access Control Panel System Power Supply Structure	17
4 Equipment Communication	19
4.1 Access Control Networking Wires and Wiring	19
4.2 TCP/IP Communication	20
4.3 RS485 Communication	20
4.4 Wireless Communication	20
4.5 DIP Switch Settings	23
4.6 USB Upgrade	23

1 Safety Instructions

1.1 Important Security Instructions

- 1) Read, follow and keep instructions: Before operating the equipment, read and follow strictly all security and operation instructions. Please keep the instructions in good condition for future reference.
- 2) Accessories: Please use the accessories recommended by the manufacturer or delivered with the product. Any other related product is not recommended as the major alarming or monitoring system. The major alarming or monitoring system should comply with the local applicable fire-prevention and security standards.
- 3) Installation cautions: Do not place this equipment on any unstable table, tripod mount, support or base, lest the equipment should fall and get damaged, and more undesirably cause severe personal injuries. Therefore, it is important to install the equipment as instructed by the manufacturer.
- 4) All peripheral devices must be grounded.
- 5) No external connection wires can be exposed. All connections and idle wire ends must be wrapped with insulating tapes to prevent accidental contact with exposed wires from damaging the equipment.
- 6) Repair: Do not attempt unauthorized repair of the equipment. Disassembly or detachment is likely to cause shock or other risks. All repair jobs should be done by qualified repair personnel.
- 7) Damages in need of repair: In any of the following cases, first disconnect the power supply from the equipment and notify qualified repair personnel for repairs:
 - ✧ The power cord or connector is damaged;
 - ✧ There is entry of liquid or any other foreign object into the equipment;
 - ✧ The equipment is wetted or exposed to bad weather (rain, snow, etc.);
 - ✧ If the equipment cannot work normally even though operated as instructed, please be sure to adjust only the control components specified in the operation instructions. Incorrect adjustment of other control components may cause damage to the equipment, and even the equipment may not be recovered;
 - ✧ The equipment falls down or its performance changes obviously.
- 8) Replacing components: If it is necessary to replace a component, the repair personnel must use only the substitutes specified by the manufacturer.
- 9) Security inspection: After the equipment is repaired, the repair personnel are supposed to conduct security inspection to ensure the equipment can work normally.
- 10) Power supply: Operate the equipment with only the type of power supply indicated on the label. Contact the operator for any uncertainty about the type of power supply.



Violation of any of the following cautions is likely to lead to personal injury or equipment failure, We will not be responsible for the damages or injuries caused thereby.

- Before installation, switch off the external circuit (that supplies power to the system), including locks.
- Before connecting the equipment to power supply, ensure the output voltage is within the specified range.
- Never connect power before completion of installation.

1.2 Installation Cautions

- 1) The conduits of wires under relay must be matched with metaled conduits, other wires can use PVC conduits, to prevent failure caused by rodent damage. Although a control panel is designed with good antistatic, lightning-proof, and leakage-proof functions, ensure its chassis and the AC ground wire are connected properly and the AC ground wire is grounded physically.
- 2) It is recommended not to plug/unplug connection terminals frequently when the system is energized. Be sure to unplug the connection terminals before starting any relevant welding job.
- 3) Do not detach or replace any control panel chip without permission, because unprofessional operation may cause damage to the control panel.
- 4) It is recommended not to connect any other auxiliary devices without permission. All non-routine operations must be communicated to our engineers in advance.
- 5) A control panel should not share one power socket with any other large-current device.
- 6) It is preferable to install card readers and buttons at heights of **1.4-1.5m** above the ground, but the heights are subject to proper adjustment according to customers' usual practice.
- 7) It is advised to install control panels at places easy of maintenance, like **a weak electric well**.
- 8) It is strongly recommended that the exposed part of any connection terminal should **not be longer than 4mm**, and specialized clamping tools may be used to avoid short-circuit or communication failure resulting from accidental contact with excessive exposed wires.
- 9) To save access control event records, export data periodically from control panels.
- 10) Get prepared countermeasures according to application scenarios for unexpected power failure, like **selecting power supply with UPS**.
- 11) If RS485 reader is connected externally and shares the power supply for the device (The control panel does not support fingerprint verification of RS485 reader), it is recommended that the connection between the EXT RS485 port and the reader be no longer than 100m. Otherwise, it is recommended that the reader use a separate power supply.
- 12) The connection between a PC and a control panel should be shorter than 1200m for RS485 communications. A length **within 800m** is recommended to make communications more stable.
- 13) To protect the access control system against the self-induced electromotive force generated by an electronic lock at the instant of switching off/on, it is necessary to **connect a diode in parallel** (please use the FR107 delivered with the system) with the electronic lock to release the self-induced electromotive force during onsite connection for application of the access control system.
- 14) It is recommended that an electronic lock and a control panel should **use respective power supplies**.
- 15) It is recommended to use the power supply delivered with the system as the control panel power supply.
- 16) In a place with strong magnetic interference, galvanized steel pipes or shielded cables are recommended, and proper grounding is required.

2 System Introduction

The access control management system is a new modernized security management system, which is an effective measure for security and protection management. It is mainly used to manage entrances and exits of important places, such as banks, hotels, equipment rooms, offices, smart communities, and factories.

2.1 System Function Parameters

- High-speed 32-bit 1.2GHz CPU, 128M RAM, and 256M Flash.
- Embedded LINUX operating system.
- The C5S110 for one-door one-way/two-way, C5S120 for two-door one-way/two-way, and C5S140 for two-door two-way or four door one-way/two-way
- A maximum of 100,000 card holders and 200,000 offline event records.
- Support of multiple Wiegand card formats and a password keypad, compatible with various types of cards.
- Use of dual communication technologies: the Ethernet plus the RS485 industrial bus, for reliable communications.
- With a watchdog (hardware) built in the control panel to prevent crash.
- Over-current, over-voltage, and inverse-voltage protection for input of power supply to the control panel.
- Over-current protection for the power supply to card readers.
- Instant over-voltage protection for all input/output ports.
- Instant over-voltage protection for communication ports.

2.2 Product Technical Parameters

- Working power supply: Rated voltage 12V ($\pm 20\%$) DC, rated current $\geq 3A$ (rated current for C5S140 $\geq 5A$)
- Working environment: Temperature $-10^{\circ}C \sim 50^{\circ}C$; humidity 20%~80%.
- Electronic lock relay output: The maximum switching voltage: 36V(DC); The maximum switching current: 5A
- Auxiliary relay output: The maximum switching voltage: 36V(DC); The maximum switching current: 2A
- With detachable connection terminals made of alloy-steel non-magnetic flange materials.
- Control panel dimensions: C5S110: 160mm*140mm*31.6mm; C5S120/140: 197mm*171mm*31.6mm
- Chassis dimensions: 308.25mm*355.2mm*67.8mm

2.3 Control Panel Indicators

When the C5S110/120/140 is powered on, normally the POWER indicator (red) is lit constantly, the RUN indicator (green) flashes (indicating the system is normal), and other indicators are all off.

However, under the following circumstances:

- 1) COMM1 indicator (yellow): flashing indicates the system is communicating with upper-level devices (for example, the PC).
- 2) COMM2 (yellow): flashing indicates the system is communicating with lower-level devices (for example, readers).

- 3) WLAN indicator (green): flashing indicates the system is communicating in wireless (WIFI) mode.
- 4) DOOR indicator (green): flashing indicates a door opening signal (a door is opened).

Diagram of C5S140 indicators:

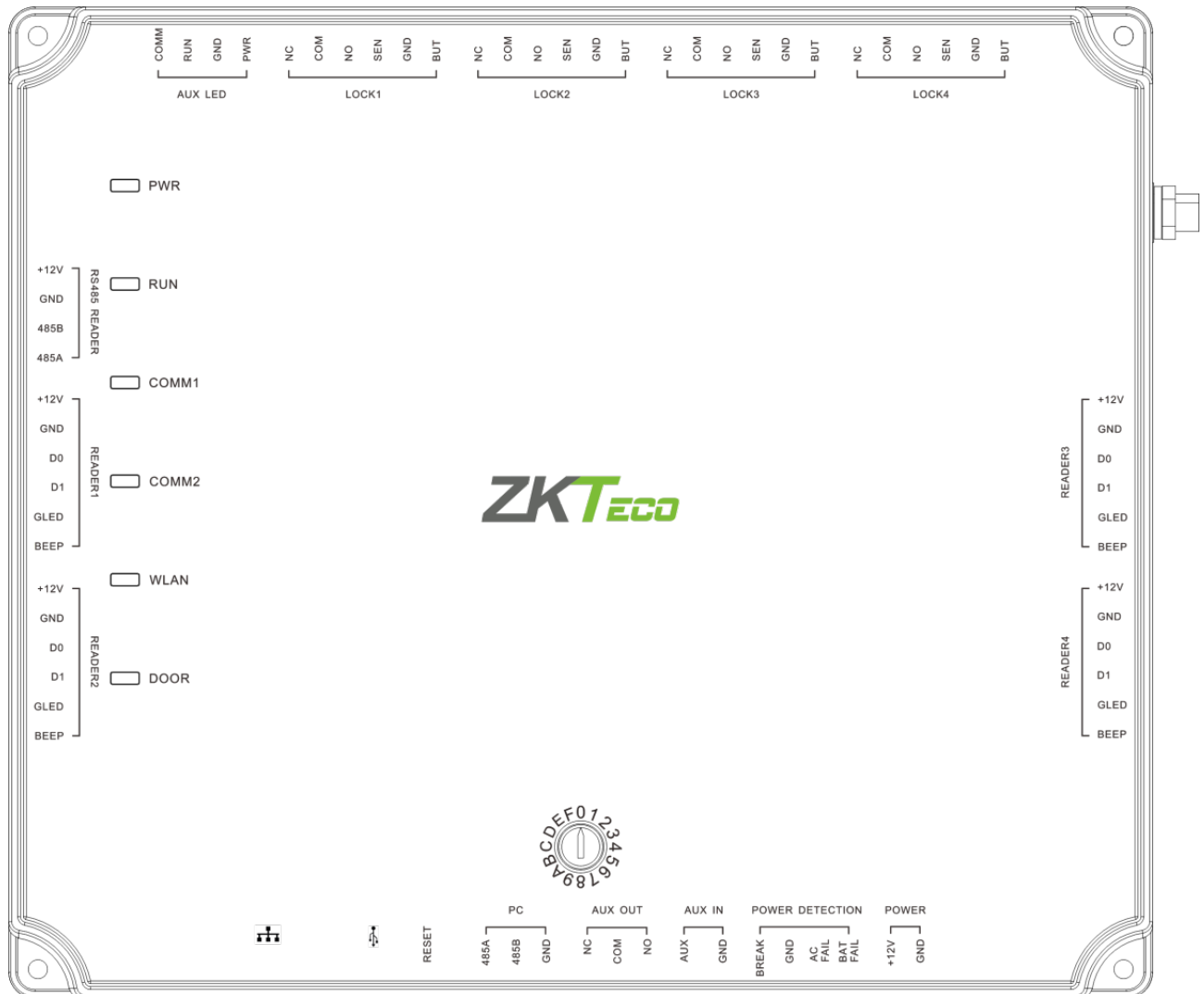

3 Installation and Connection

3.1 Chassis Installation

➤ The following describes the chassis installation process:

If the provided chassis is used, the control panel has been installed inside the chassis by default. Fix the chassis on the wall, remove the hole plug or get through the thread hole, connect the access control cable, and install other components.

😊 **Remarks:** The control panel has a guide rail on the back. If you need to install the control panel separately without the chassis, you can use the guide rail to fix the control panel. The following figures show how to fix the control panel using the guide rail.

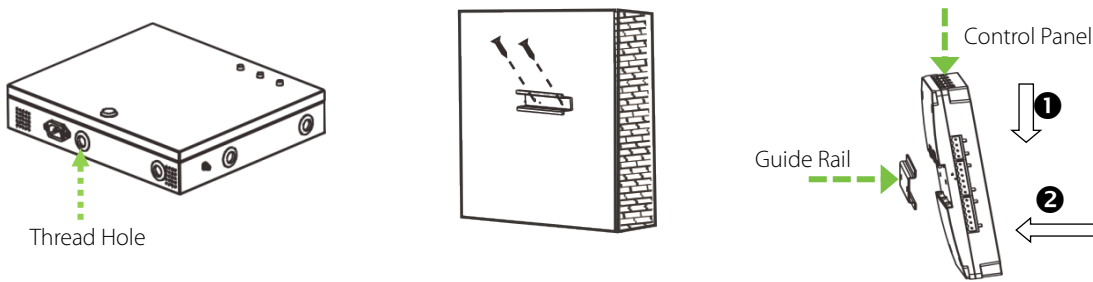

- 1) Remove the hole plug or get through the thread hole 2) Fix the guide rail on the wall 3) Install other components

➤ The following shows the chassis appearance and internal structure:

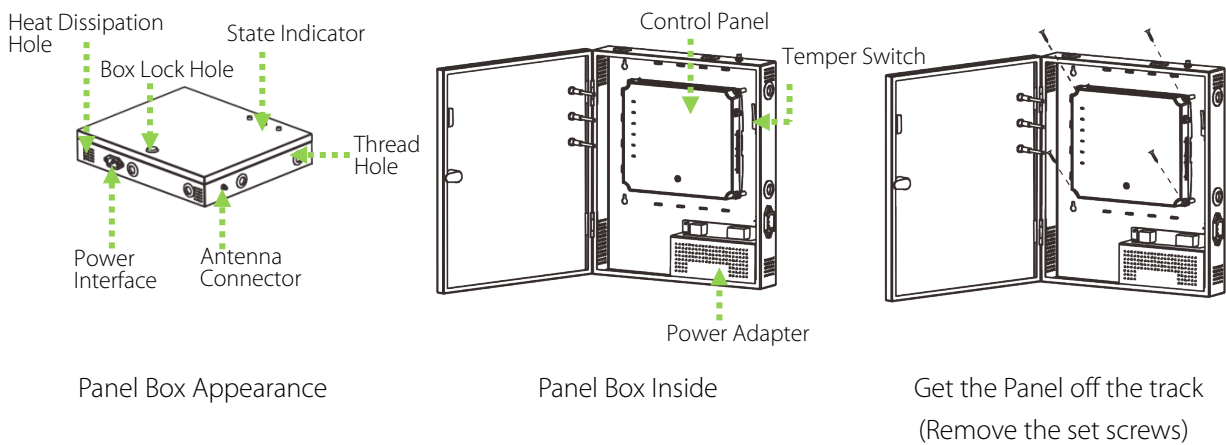

3.2 Installation of Access Control Panel Wires

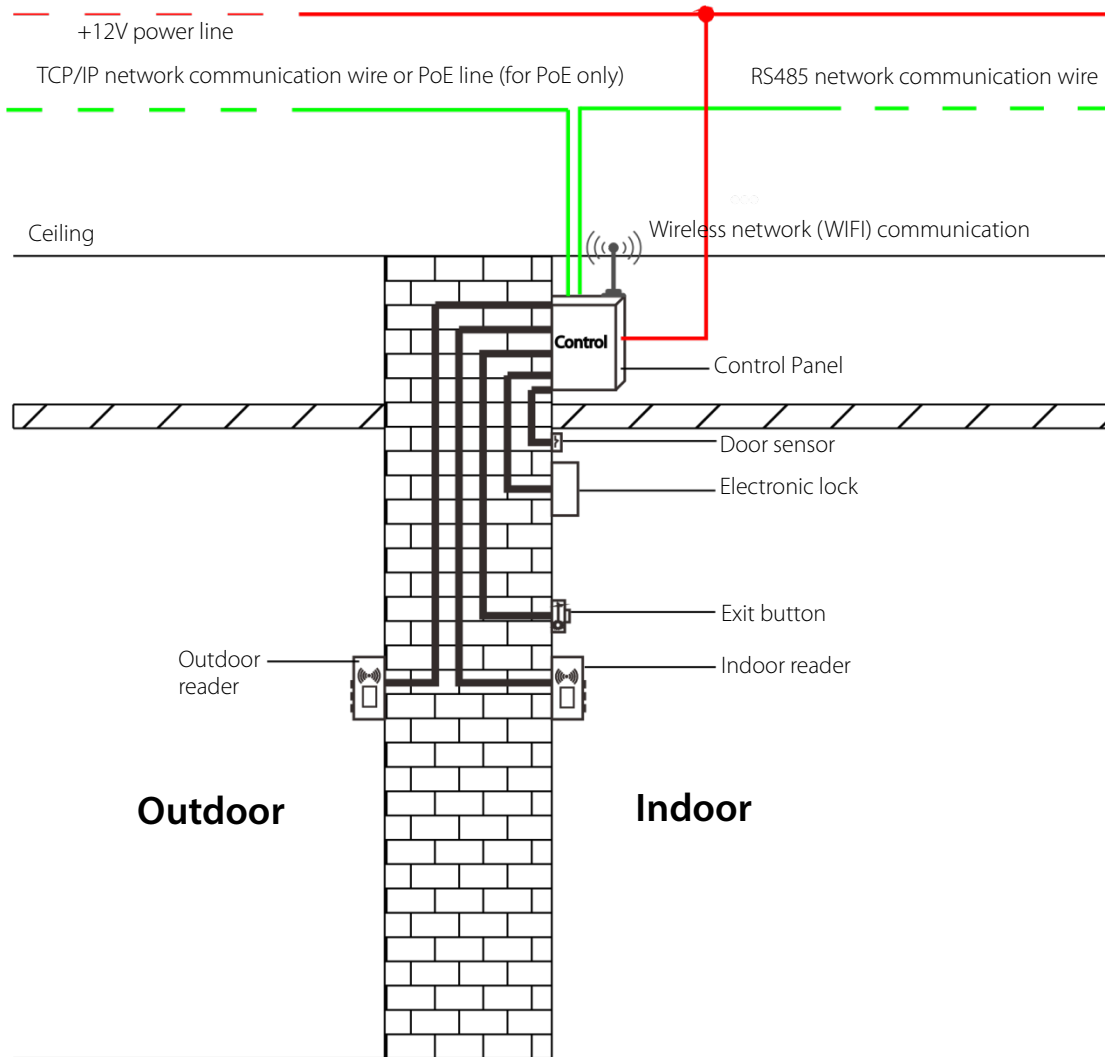

Access Control Panel Wire Installation Diagram

😊 Remarks:

- Before connection, make sure the power supply is disconnected, because connection with power connected will cause severe damage to the equipment.
- The access control wires must be separated according to heavy and light current; the control panel wires, electronic lock wires, and exit button wires must run through their respective casing pipes.

3.3 Control Panel System Installation

Controlling one-way entry/exit of four doors(Wiegand Readers)

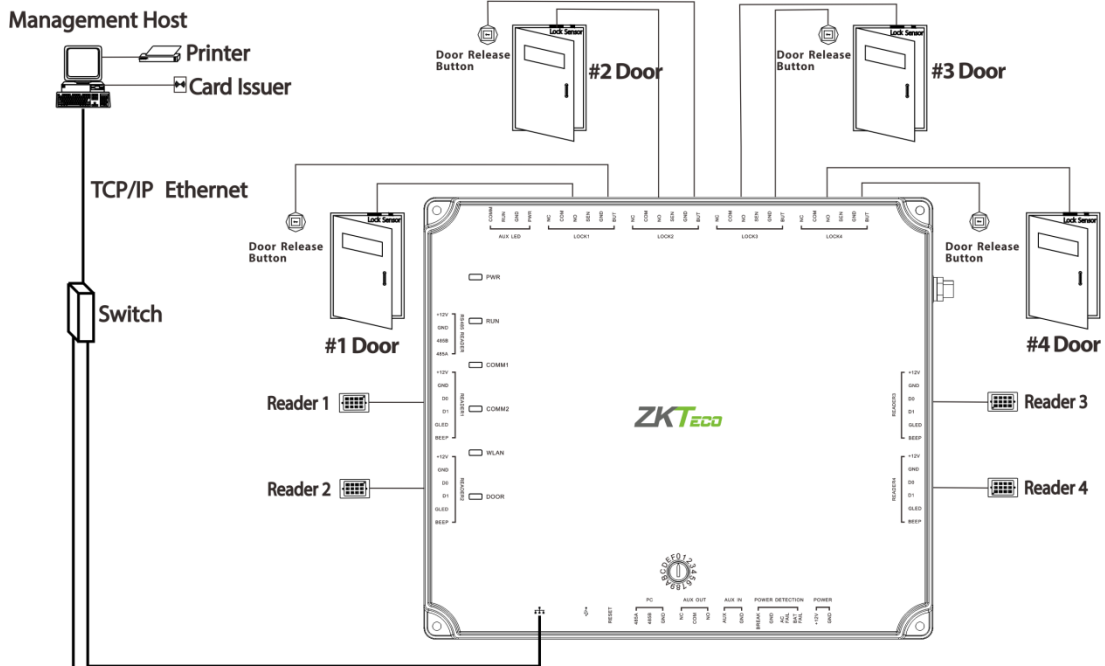

Controlling two-way entry/exit of four doors(RS485 Readers)

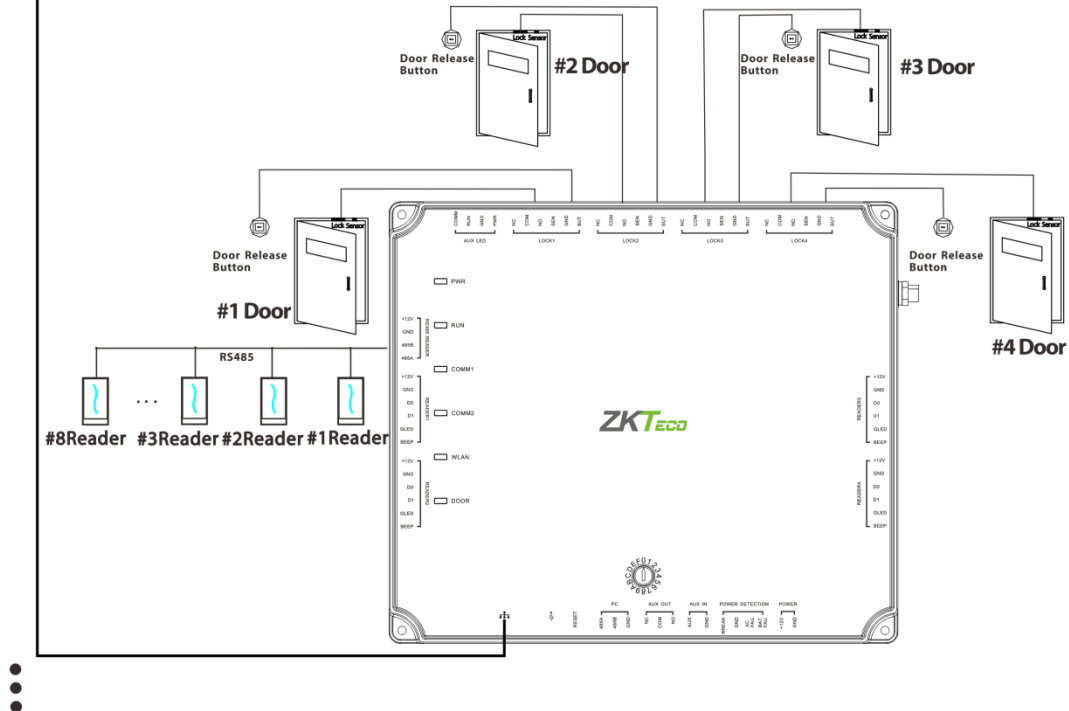

Schematic Diagram of C5S140 System Installation

Note: Despite the preceding example of four-door one-way/two-way, C5S140 also can be connected to two-door two-way. C5S110 can be connected to one-door one-way/two-way at most, and C5S120 can be connected to two-door one-way/two-way.

The access control management system consists of two parts: management workstation (PC) and control panel.

The management workstation and control panel communicate through TCP/IP, RS485, and wireless network (WIFI). On a single RS485 bus, each management workstation can be connected to a maximum of 16 C5S control panels (with a maximum of 16 bits of DIP switch, a maximum of 16 device numbers can be set). The communication wires should be kept away from high-voltage wires as far as possible, and should be neither routed in parallel with nor bundled with power wires.

A management workstation is actually a PC connected to the network. By running the access control management software installed in the PC, access control management personnel can remotely perform various management functions, like adding/deleting a user, viewing event records, opening/closing doors, and monitoring status of each door in real time.

3.4 Control Panel Connection Terminals

C5S110 terminal connection diagram

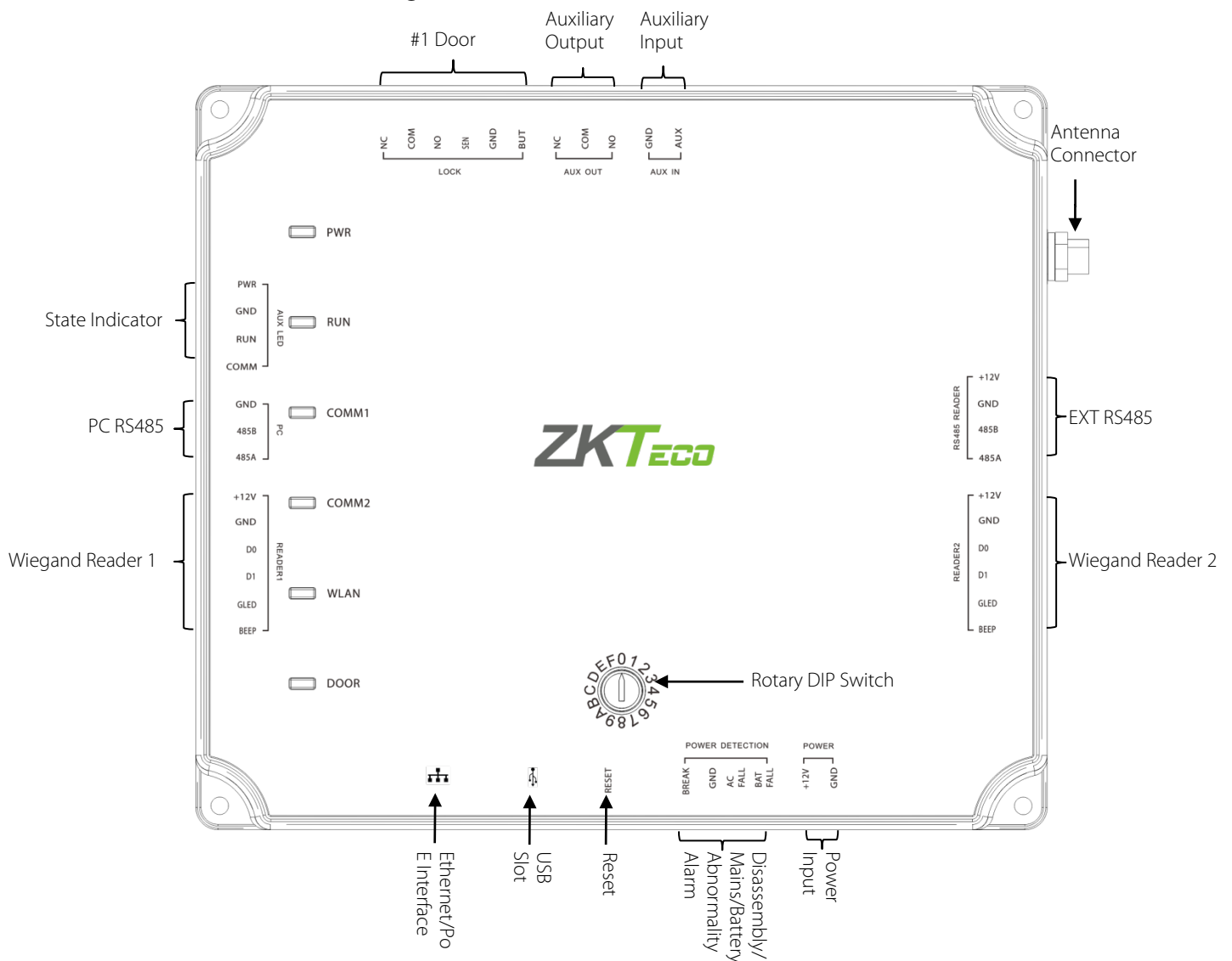

C5S120 terminal connection diagram

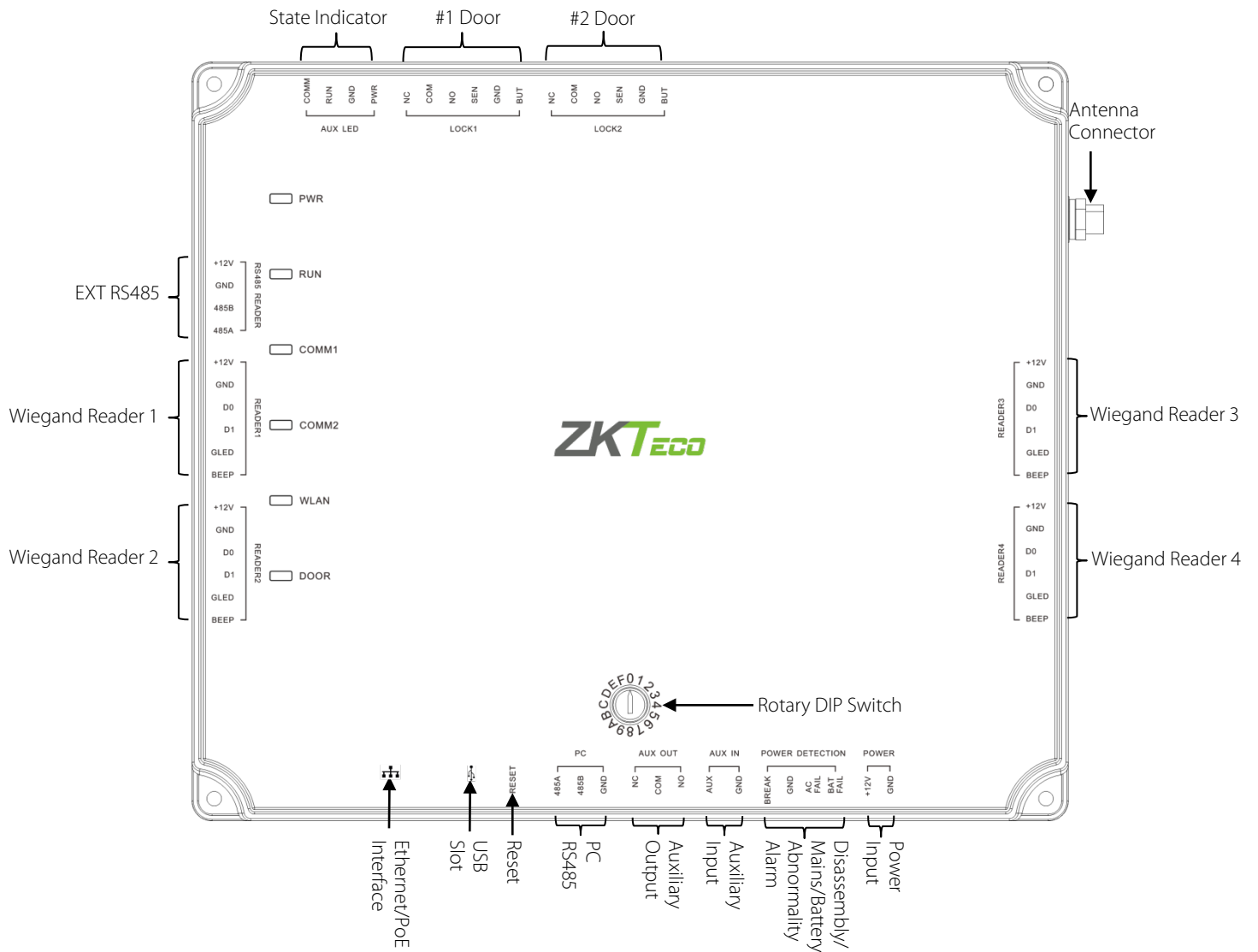

C5S140 terminal connection diagram

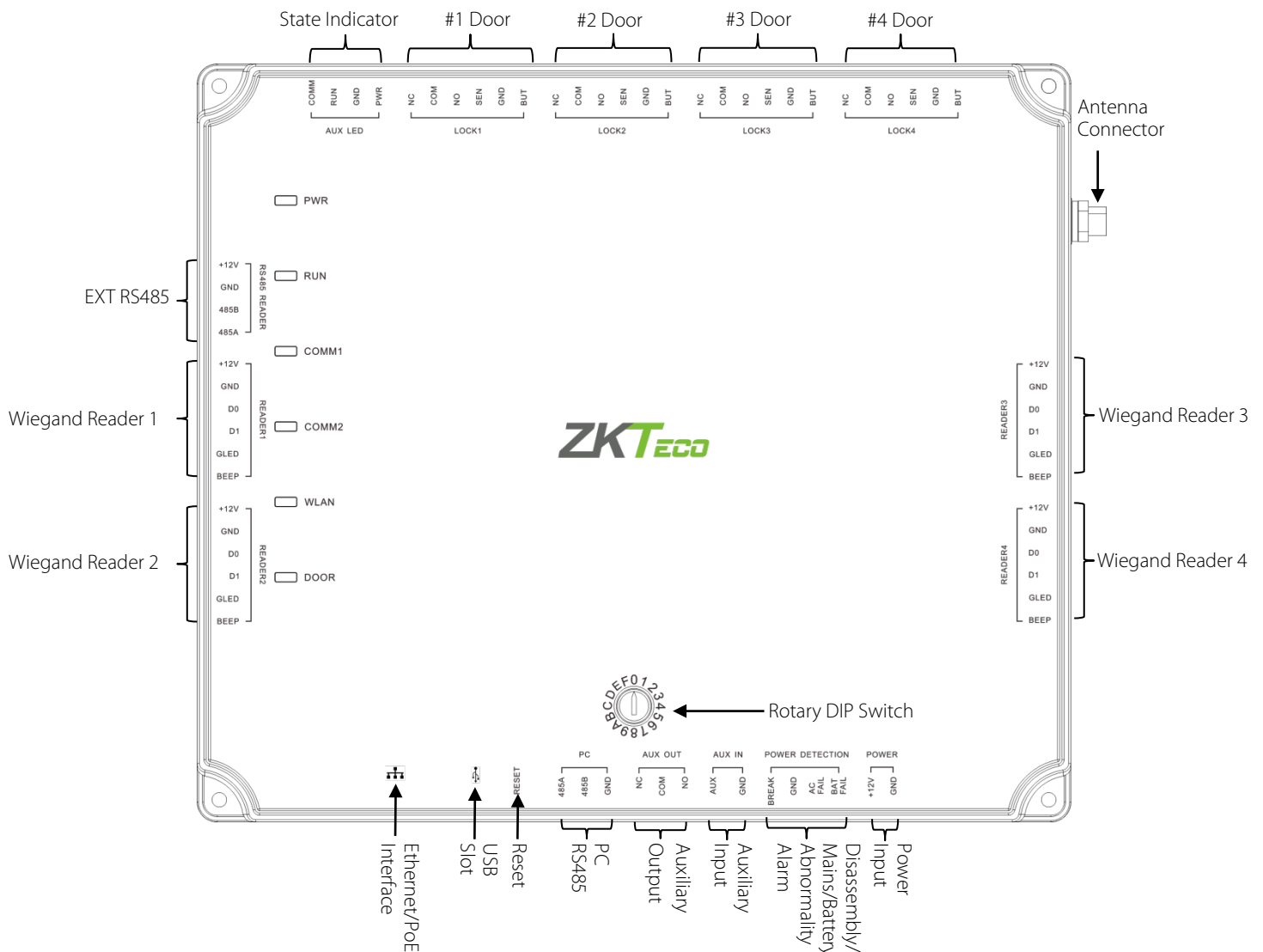

● Descriptions of the terminals:

- 1) The auxiliary input may be connected to infrared body detectors, fire alarms, or smoke detectors.
- 2) The auxiliary output may be connected to alarms, cameras or door bells, etc.
- 3) State Indicators are connected to the chassis, with is power indicator, run status indicator and communication status indicator.
- 4) PC RS485 indicates the RS485 cable is connected to the PC through this port. The EXT RS485 port can be connected externally to RS485 reader.
- 5) All the terminals mentioned above are set through relevant access control software. Please see the respective software manual for details.

Ports on the C5S Series control panel:

No.	Functional Port	C5S110 (One-Door Two-Way)	C5S120 (Two-Door Two-Way)	C5S140 (Four-Door One-Way/Two-Door Two Way)
1	Wiegand reader interface	2	4	4
2	Exit button	1	2	4
3	Control lock relay	1	2	4
4	Door sensor	1	2	4
5	Auxiliary Input	1	1	1
6	Auxiliary Output	1	1	1
7	RS485 reader	2	4	8
8	RS485 & PC communication	√	√	√
9	RS485 extension communication	√	√	√
10	TCP/IP	√	√	√
11	Wireless communication (WIFI)	√	√	√

3.5 Connection with Door Sensors, Exit Switches, and Auxiliary Input Devices

1) Door sensor

A door sensor is used to sense the open/closed status of a door. With a door sensor switch, an access control panel can detect illegal opening of a door, and will trigger an output of alarm. Moreover, if a door is not closed within a specified period of time after it is opened, the door control panel will also prompt an alarm. It is recommended to select two-core wires with a gauge over 0.22 mm². A door sensor may be omitted if it is unnecessary to monitor online the open/closed status of a door, give out an alarm when the door is not closed for a long time or there is illegal access, and use the interlock function.

2) Exit switch

An exit switch is a switch installed indoors to open a door. When it is switched on, the door will be opened. An exit button is fixed at a height of about 1.4m above the ground. Ensure it is located in the right position without slant,

and its connection is correct and secure. (Cut off the exposed end of any unused wire and wrap it with insulating tape.) Note to guard against electromagnetic interference (such as light switches and computers). It is recommended to use two-core wires with a gauge over 0.3mm² as the connection wire between an exit switch and a control panel.

3) Auxiliary input

C5S series control panel provides one auxiliary input interface; which are connected to infrared body detectors, smoke detectors, gas detectors, window magnetic alarms, wireless exit switches, etc. Auxiliary inputs are set through relevant access control software. Please see the respective software manual for details.

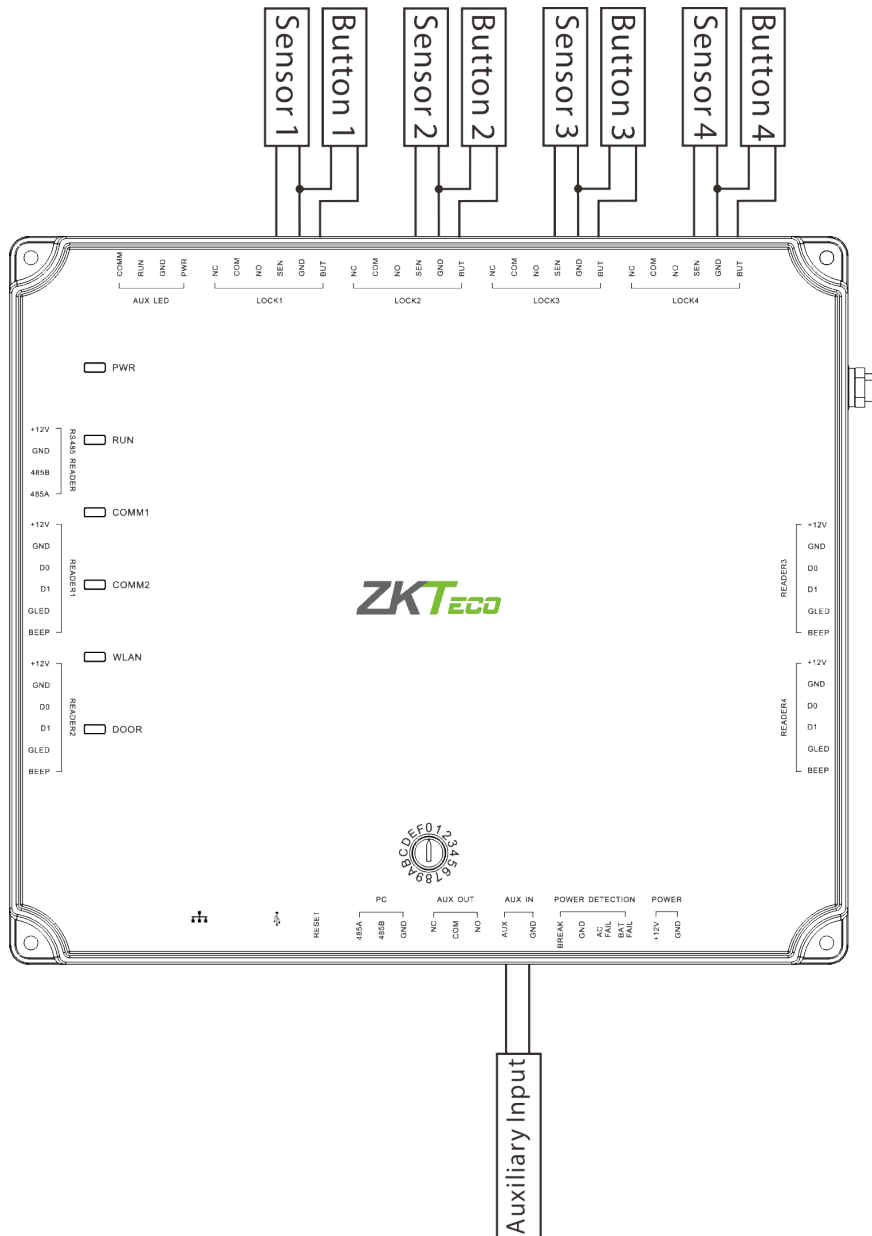

Connections between C5S140 and Door Sensors, Exit Switches, and Auxiliary Input Devices

3.6 Connection with Readers

The control panel supports RS485 reader and Wiegand reader (Note: The control panel does not support

fingerprint verification of RS485 reader).

1) Connection with RS485 Readers

C5S110 can connect two RS485 readers in the one-door two-way mode. C5S120 provides four readers, which can be connected in the two-door two-way mode. C5S140 provides eight readers, which can be connected in the four-door two-way mode.

RS485 reader connection: First of all, set the RS485 address (device number) of the reader by DIP switch or other ways.

Control Panel \ RS485 address	1	2	3	4	5	6	7	8
C5S110	1Door IN	1Door OUT						
C5S120	1Door IN	1Door OUT	2Door IN	2Door OUT				
C5S140	1Door IN	2Door IN	3Door IN	4Door IN	1Door OUT	2Door OUT	3Door OUT	4Door OUT

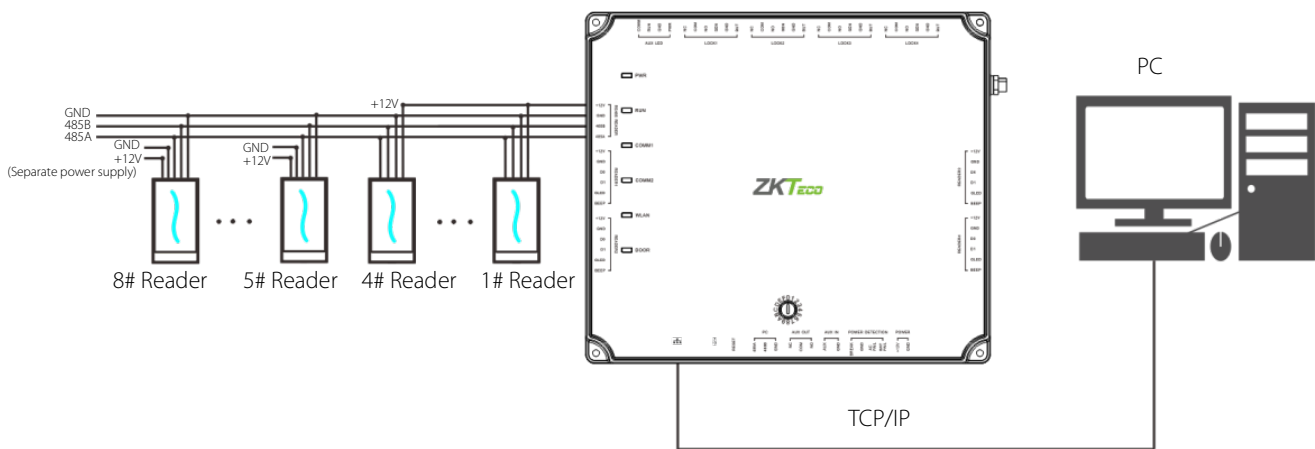

Connection between C5S140 and RS485 Readers

Besides, a single EXT RS485 interface can supply maximum 750 mA (12V) current. So the entire current consumption should be less than this max value when the readers share power with the panel. In calculation, please use max current of the reader, and start current is usually more than twice of the normal work current, please consider of this situation.

For example, use the KR502M-RS card reader, the standby current is less than 80mA, the max current is less than 90mA, When the device is start, Instantaneous current can reach 180 mA. As RS485 reader, consider the starting current is bigger, through the EXT RS485 interface can only connect four readers for power supply. So the power of control panel connect only nearest 4 readers.

If RS485 reader is connected externally and shares the power supply for the device, it is recommended that the

connection between the EXT RS485 port and the reader be no longer than 100m. Otherwise, it is recommended that the reader use a separate power supply.

For some of the devices with much greater consumption, we suggest to using the separately power supplies, to make sure the steady operation.

2) Connection with Wiegand Readers

C5S110 can connect two Wiegand readers in the one-door two-way mode. C5S120 provides four readers, which can be connected in the two-door two-way mode. C5S140 provides four readers, which can be connected in the two-door two-way or four-door one-way mode.

The Wiegand interfaces provided by the C5S series can be connected to different types of readers. If your reader does not use the voltage of DC 12V, an external power supply is needed. A reader should be installed at a height of about 1.4m above the ground and at a distance of 30-50mm away from a door frame.

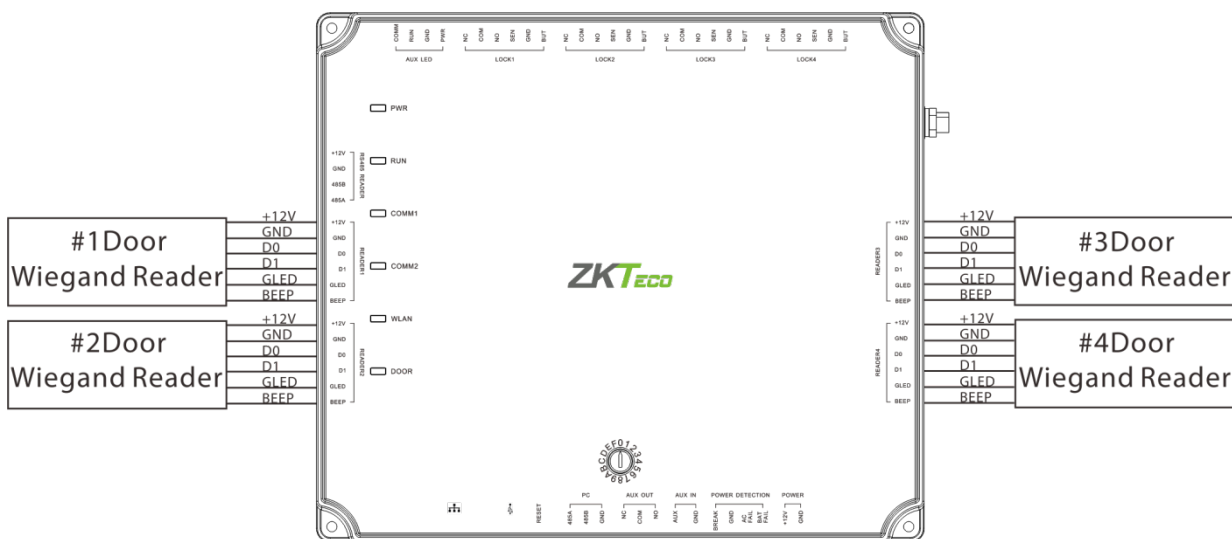

Connection between C5S140 and Wiegand Readers

3.7 Relay Output Connection

C5S110 has two relays (one used as a control lock by default, and the other used as an auxiliary output); C5S120 has three relays (two used as control locks by default, and the other one used as auxiliary outputs); C5S140 has five relays (four used as control locks by default, and the other one used as auxiliary outputs).

The relays for auxiliary outputs may be connected to monitors, alarms, door bells, etc. Auxiliary outputs are set through relevant access control software. Please see the respective software manual for details.

- 1) The default connection mode of the door lock is "dry mode". Specifically, the electrical lock uses an external power supply separately, rather than share the power supply for the control panel. The wiring mode of the door lock relay cannot be changed, while that of the auxiliary output relay can. The following uses the example of door lock connection to describe the output relay connection.
- 2) An access control panel provides multiple electronic lock outputs. The COM and NO terminals are applicable to the locks that are unlocked when power is connected and locked when power is disconnected. The COM and NC terminals are applicable to the locks that are locked when power is connected and unlocked when power is disconnected.

- 3) Our access control panel is powered by standard PoE or access control power. You can choose either of the two power supplies as needed. The two power supplies provide 12V/3A power for only the power consumption of the control panel, Wiegand readers, and output power consumption of RS485 reader.
- 4) To protect the access control system against the self-induced electromotive force generated by an electronic lock at the instant of switching off/on, it is necessary to connect a diode in parallel (please use the FR107 delivered with the system) with the electronic lock to release the self-induced electromotive force during onsite connection for application of the access control system. The following uses the example of C5S140:

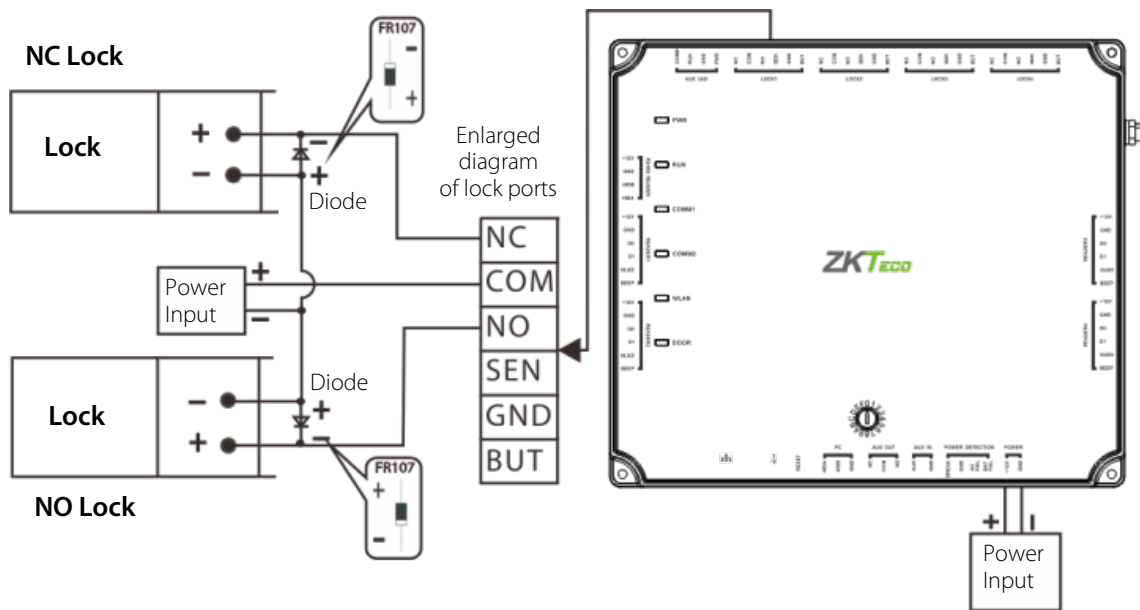

"Dry mode" wiring diagram of lock connecting

3.8 Access Control Panel System Power Supply Structure

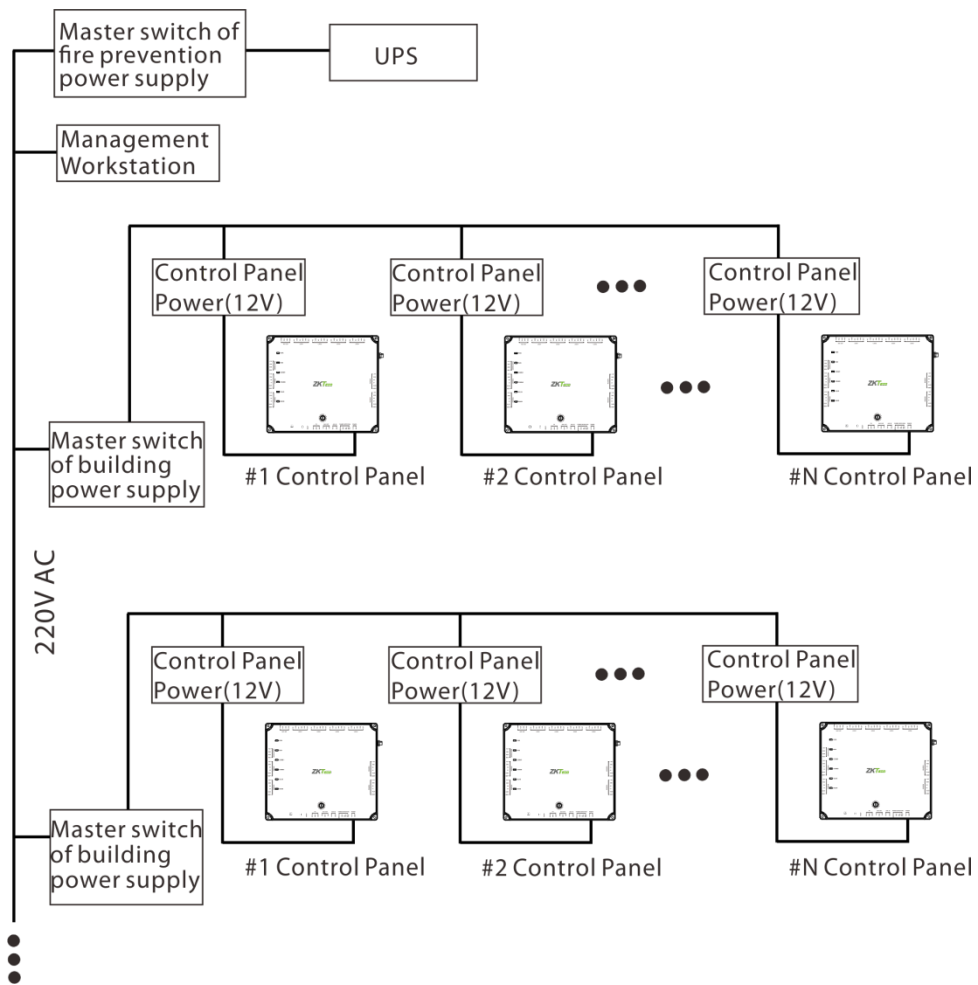

Access Control Panel System Power Supply

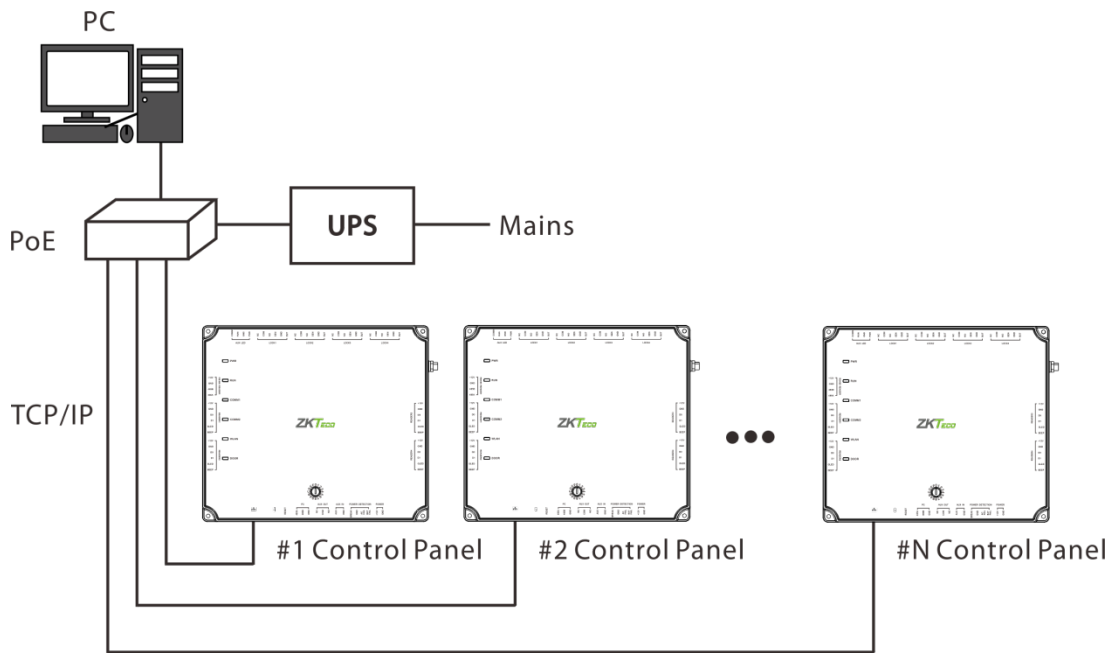

PoE System

The C5S access control panel is powered through a +12 V DC power supply or PoE, whichever can be chosen.

If you choose a +12 V DC power supply, generally, to reduce power interference between control panels, each control panel should be powered separately.

If you choose PoE, the TCP/IP network interface of the access control panel can serve as a PoE interface and a PC communication interface. The PoE switch must conform to IEEE802.3at standards.

To prevent power failure of a control panel from making the whole system unable to work normally, the access control management system is usually required to have one UPS at least, and access control locks are powered externally to guarantee the access control management system can still work normally during power failure.

4 Equipment Communication

The background PC software is able to communicate with the system according to three protocols (TCP/IP, RS485 and WIFI) for data exchange and remote management.

4.1 Access Control Networking Wires and Wiring

- 1) RS485 communication wires are made of internationally accepted shielded twisted pairs (RVVSP), which prove effective to prevent and shield interference.
- 2) The power supply is 12V DC converted from 220V or PoE.
- 3) The Wiegand readers use 6-core communication shielded wires (RVVSP 6×0.5mm) (usually there are 6-core, 8-core, and 10-core types available for users to select according to the ports) to reduce interference during transmission.
- 4) As an electronic lock has a big current, it generates strong interference signal during an action. To reduce the effect of an electronic lock during an action on other elements, 4-core wires (RVVP 4×0.75mm², two for a power supply and two for a door sensor) are recommended.
- 5) "EXT RS485" interface use 4-core communication shielded wires (RVVSP 4×0.5mm).
- 6) Other control cables (like exit switches) are all made of 2-core wires (RVVSP 2×0.5mm²).
- 7) Notes for wiring:
 - ✧ Signal wires (like network cables and RS485 wires) can neither run in parallel with nor share one casing pipe with large-power electric wires (like electronic lock wires and power cables). If parallel wiring is unavoidable for environmental reasons, the distance must be over 50cm.
 - ✧ Try to avoid use of any conductor with a connector during distribution. When a connector is indispensable, it must be crimped or welded. No mechanical force can be applied to the joint or branch of conductors.
 - ✧ In a building, distribution lines must be installed horizontally or vertically. They should be protected in casing pipes (like plastic or iron water pipes, to be selected according to the technical requirements of indoor distribution). Metal hoses are applicable to ceiling wiring, but must be secure and good-looking.
 - ✧ Shielding measures and shielding connection: If the electromagnetic interference in the wiring environment is found strong in the survey before construction, it is necessary to consider shielding protection for data cables when designing a construction scheme. Overall shielding protection is required if there is a large radioactive interference source or wiring has to be parallel with a large-current power supply on the construction site. Generally, shielding measures include: keeping a maximum distance from any interference source, and using metal wiring troughs or galvanized metal water pipes to ensure reliable grounding of the connection between the shielding layers of data cables and the metal troughs or pipes. Note that a shielding enclosure can have a shielding effect only when it is grounded reliably.
 - ✧ Ground wire connection method: Reliable large-diameter ground wires in compliance with applicable national standards are needed on the wiring site, and should be connected in a tree form to avoid DC loop. These ground wires must be kept far away from lightning fields. No lightning conductor can serve as a ground wire, and ensure there is no lightning current through any ground wire when there is lightning. Metal wiring troughs and pipes must be connected continuously and reliably, and linked to ground wires through large-diameter wires. The impedance of this section of wire cannot exceed 2ohm. The shielding layer also must be connected reliably, and grounded at one end to guarantee uniform current direction. The ground wire of the shielding layer must be connected through a large-diameter (not smaller than 2.5mm²) wire.

4.2 TCP/IP Communication

The Ethernet 10/100Base-T Crossover Cable, a type of crossover network cable, is mainly used for cascade hubs and switches, or used to connect two Ethernet end-points directly (without a hub). Both 10Base-T and 100Base-T are supported.

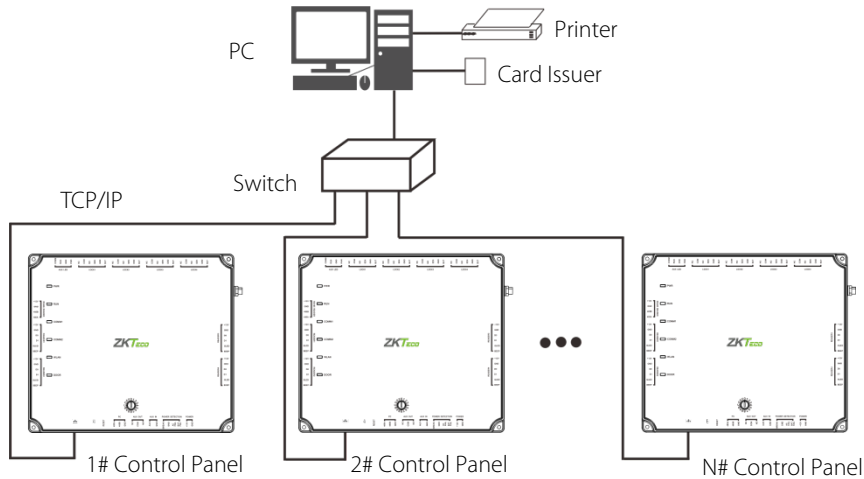

TCP/IP Communication System Networking

For ZKAccess3.5 software: Click [Device] > [Device] > [Add], also you can click [Device] > [Search Device] to search devices which in the network, and directly add from the searching result.

4.3 RS485 Communication

- 1) Internationally accepted RVSP (shielded twisted-pair) wires should be used for communication to effectively avoid interference.
- 2) RS485 communication wires should be connected by means of bus cascade connection instead of in a star form, to achieve a better shielding effect by reducing signal reflection during communications
- 3) Considering stability of communication, it is recommended the length of RS485 bus is less than 600m.
- 4) Up to 16 device numbers can be set because the rotary DIP switch on the control panel has 16 bits. Therefore, a single RS485 bus can be connected to 16 access control panels at most.
- 5) To enhance the stability of communication when the bus is longer than 300m, connect the provided 120-ohm terminal resistor between the 485A and 485B wires of the first and last control panels respectively.

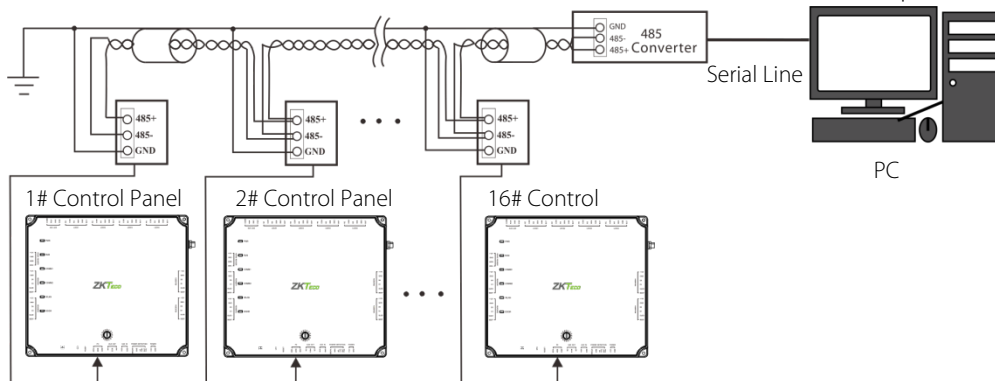

RS485 Communication System Networking

4.4 Wireless Communication

- 1) Create a valid connection string using TCP/IP, and make sure that there is available WiFi network.
- 2) Input the IP address of the controller (factory default is 192.168.1.201) in the address bar; enter the user name and password (both are **admin**), and click [Sign In] to access the ZKPanelWeb.



Note:

1. Must configure IP address of the controller and Server (PC) in the same network segment
2. When the controller's IP address is unknown, you can obtain the IP through searching device in the software.
- 3) Click [TCP/IP Settings] to modify the IP address and gateway address; Extended Network Card Setting is set when the controller is connected to TCP/IP reader. For detailed setting methods, please refer to the instructions of TCP/IP reader.

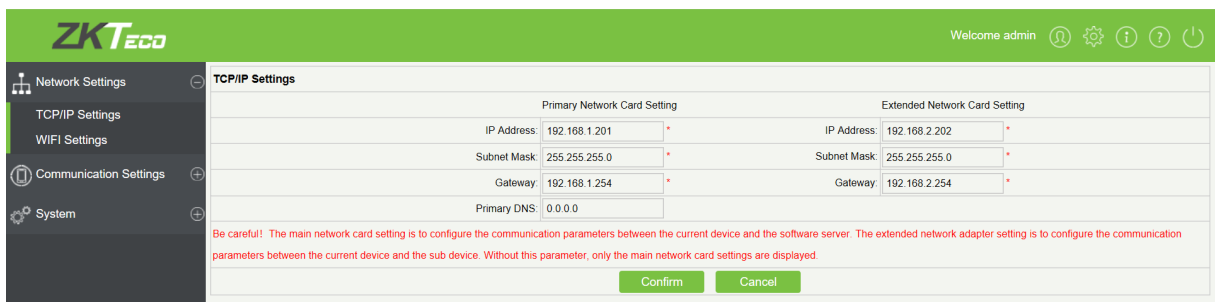

- 4) Click [WiFi Settings] > [Search] to search the available WiFi.

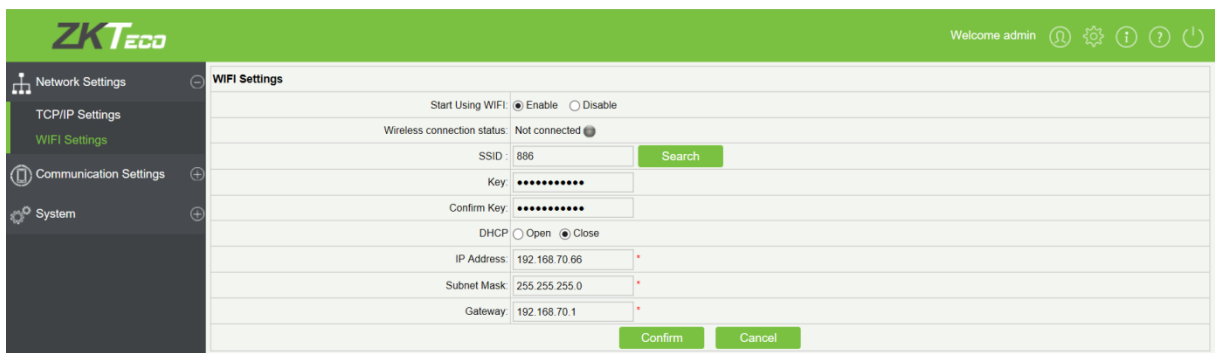

- 5) Select available WiFi in the wireless network list and click [Action] (Figure 1), enter the key, and configure DHCP (the IP address and gateway must be in the same network segment as the wireless network IP address), and then click [Confirm]. After the connection is successful, the wireless connection status shows connected (as shown in Figure 2), and the device's WLAN indicator turns green.



figure 1



figure 2

Note: The PC (server) must be on the same network segment as the router (wireless network).

- 6) Switch network connection in the software.

For ZKAccess3.5 software: Select the added C5S control panel on the Device page and click [More...] > [Set up WiFi], as figure 3, set the WIFI parameters of the control panel based on the router parameters. Restart the control panel to make the WIFI settings take effect.

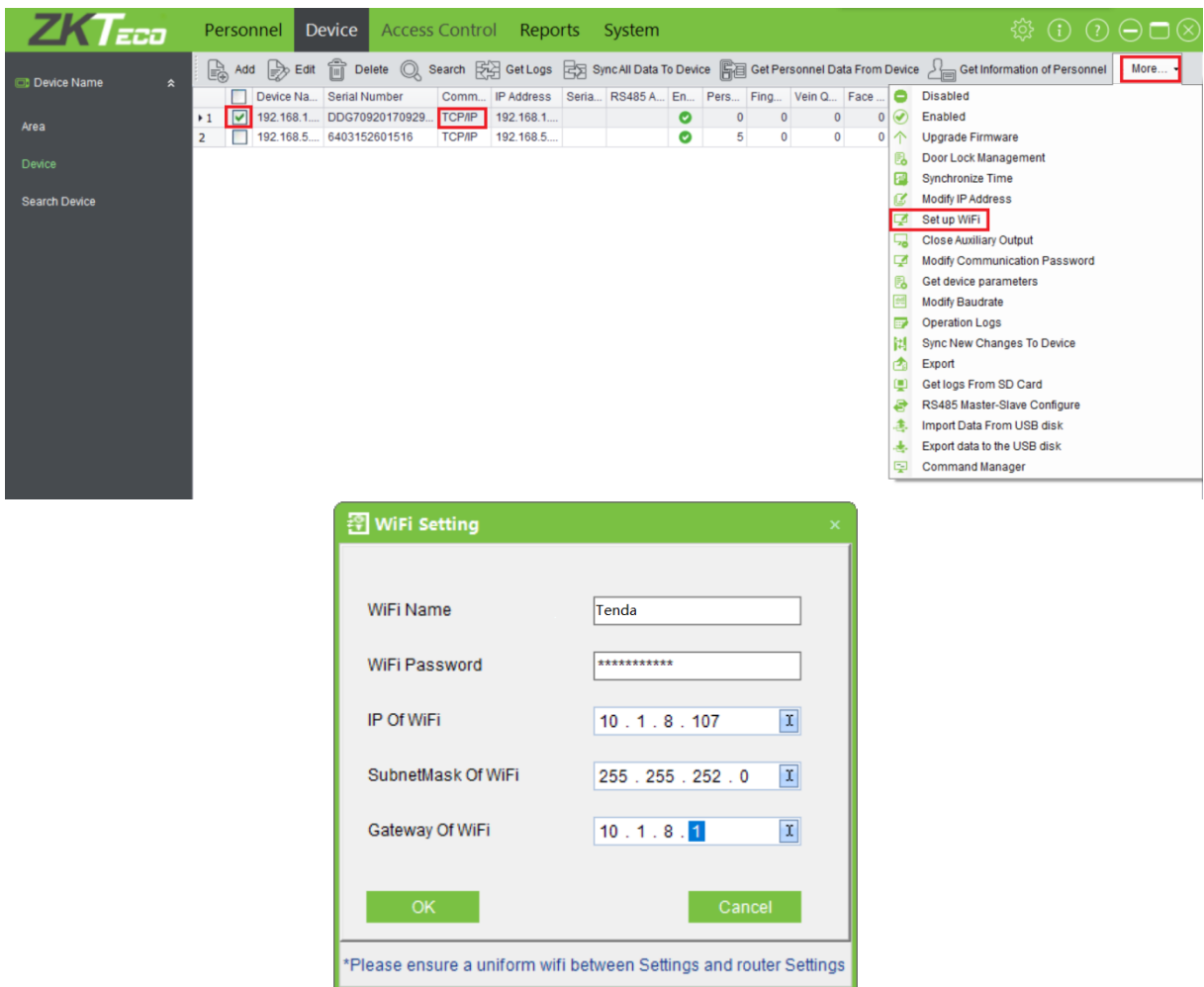

figure 3

Remarks:

- You must add the C5S control panel to the software through TCP/IP before setting WIFI parameters. Connection through RS485 is not allowed.
- Connect the PC with the software installed to the router and set the same network segment to allow the control panel to communicate with the PC and background software through WIFI.
- For details about how to add devices and set WIFI, see the software instructions.

4.5 DIP Switch Settings

C5S series control panel adopts a rotary DIP switch. The 0–F bits of the rotary DIP switch indicate device numbers 1–16 during RS485 communication. (Switch 0 indicates device number 16; switch 1 indicates device number 1, and so on. Switch F indicates device number 15). You can rotate the 0–F bits of the rotary DIP switch to corresponding positions to set device numbers, and then restart the control panel to make the setting take effect. Address numbers cannot be repetitive.

4.6 USB Upgrade

The USB slot is primarily used for control panel upgrade, the following describes how to use it:

- 1) Create a [Udisk] folder in the USB disk and save the upgrade file in the folder.
- 2) When the control panel works normally, insert the USB disk, press the Reset button and hold it for 1 to 5 seconds (the RUN indicator flashes), and release it.
- 3) The RUN indicator keeps flashing during the upgrade (you must not cut the power or remove the USB disk). The machine will restart automatically after upgrade operation succeeds.
- 4) If upgrade operation fails, the machine will return normal.