

GENERAL QUICK START GUIDE

2.8 Inch Palm & Fingerprint

Time Attendance & Access Terminal

Version: 1.0

Date: May., 2017

Note: The picture and function presented in this manual are only for reference.
The following functions are optional: Palm, RFID, Wi-Fi, Access, Battery, 3G.

Safety Precautions

The following precautions are to keep user safe and prevent any damage.
Please read carefully before installation.



Do not install the device in a place subject to direct sunlight, humidity, dust or soot.



Do not place a magnet near the product. Magnetic objects such as magnet, CRT, TV, monitor or speaker may damage the device.



Do not place the device next to heating equipment.



Be careful not to let liquid like water, drinks or chemicals leak inside the device.



Do not let children touch the device without supervision.



Do not drop or damage the device.



Do not disassemble, repair or alter the device.



Do not use the device for any purpose other than those specified.



Clean the device often to remove dust on it. In cleaning, do not splash water on the device but wipe it out with smooth cloth or towel.

Contact your supplier in case of a problem.

Device Overview

Front

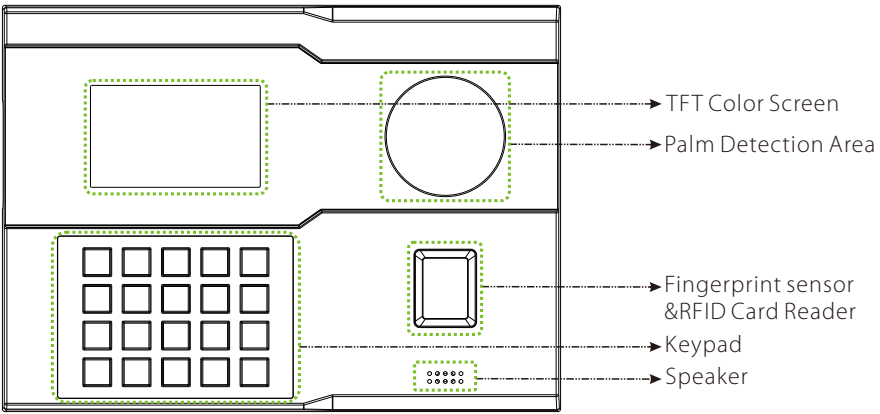

Side

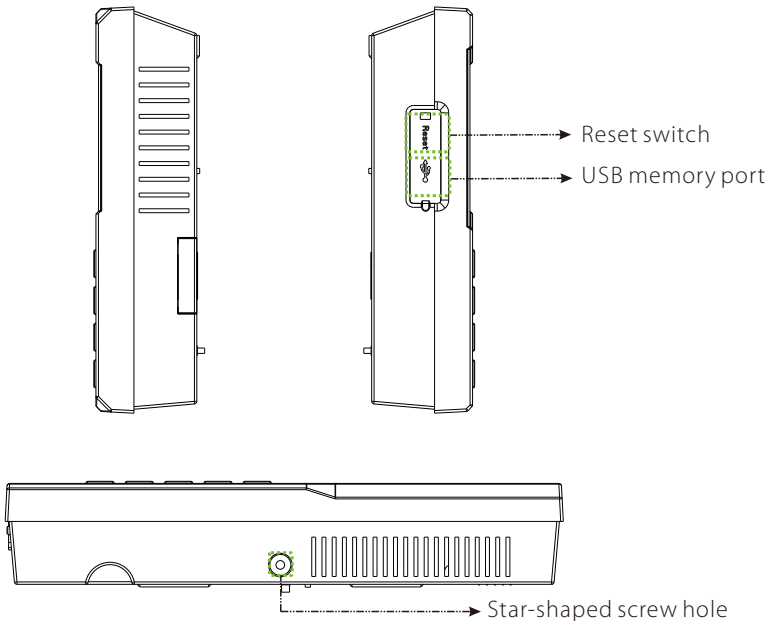

Product PIN Diagram

Back

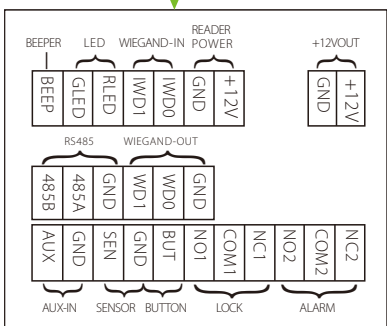
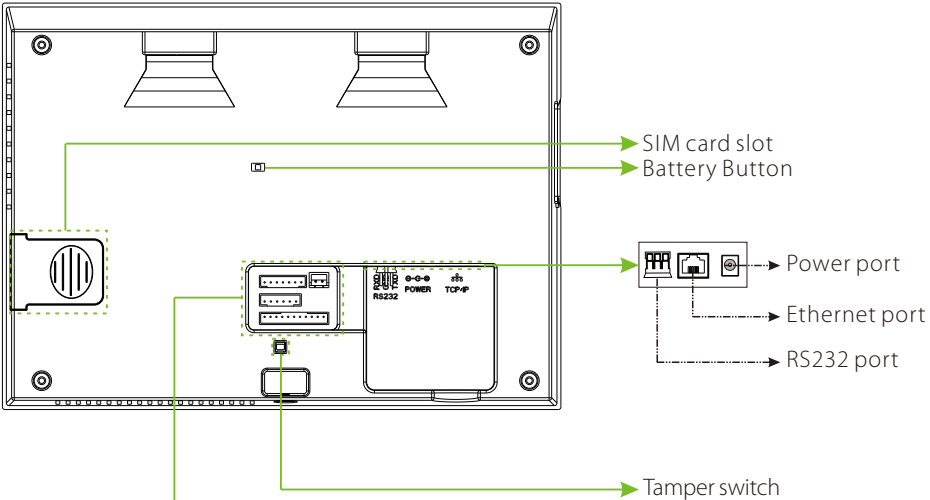

Installation & Printer Connection

❖ Mounting the device on wall

1

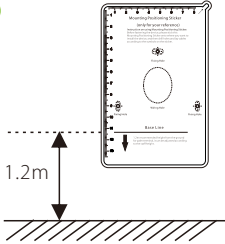

2

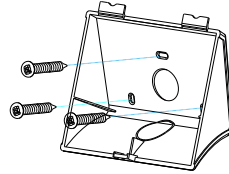

3

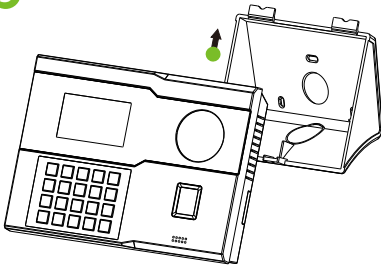

4

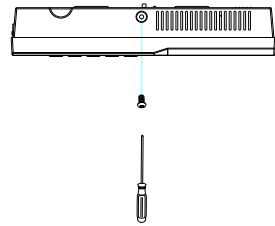

- ① Paste the mounting template sticker onto the wall, and drill holes according to the mounting paper.
- ② Fix the back plate onto the wall using wall mounting screws.
- ③ Insert the device into back plate.
- ④ Use security screw to fasten the device to back plate.

❖ Printer Connection

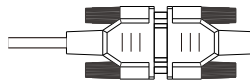
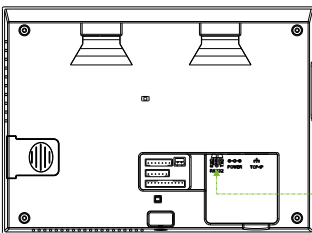

RS232 cabel

Serial Printer

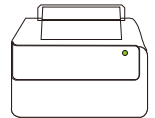

Ethernet & USB & Power Connection

❖ LAN Connection

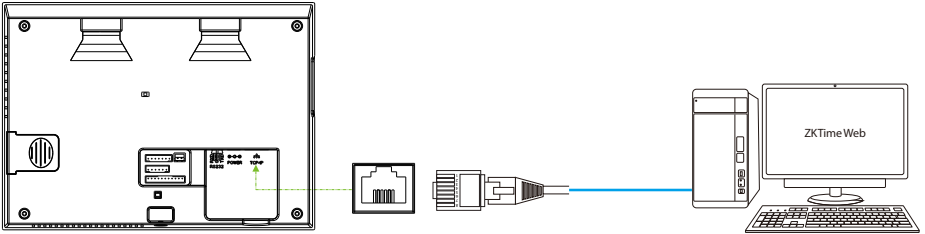

❖ USB Connection

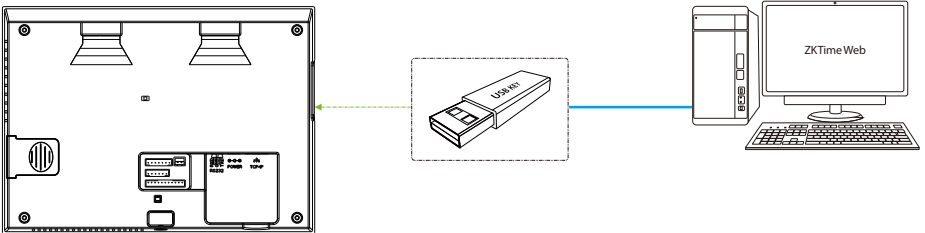

❖ Power Connection

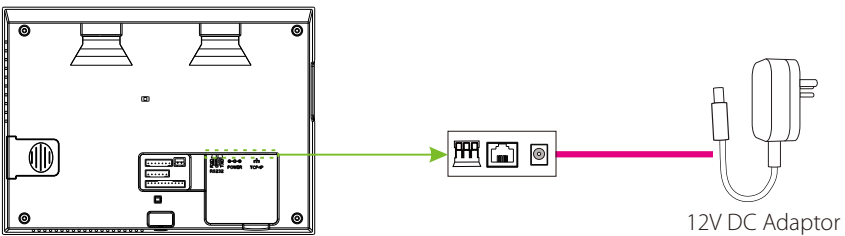

Recommended power supply

- 1) 12V \pm 10%, at least 1500mA.
- 2) To share the power with other devices, use a power supply with higher current ratings.
- 3) Battery is an optional function. You may not use the UPS.

Lock Relay Connection

The system supports Normally Opened Lock and Normally Closed Lock. For example the NO LOCK (normally)opened

❖ Device not sharing power with the lock

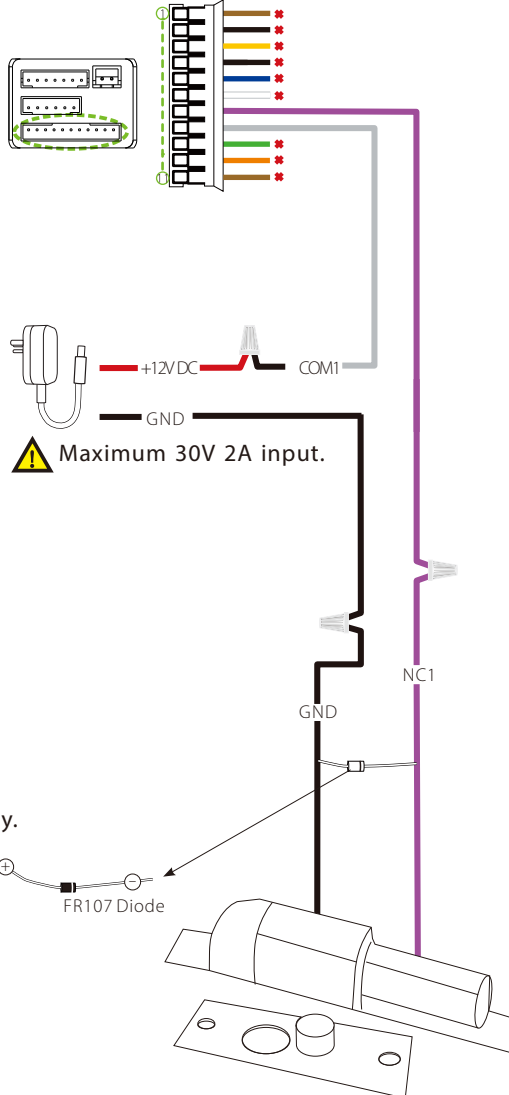
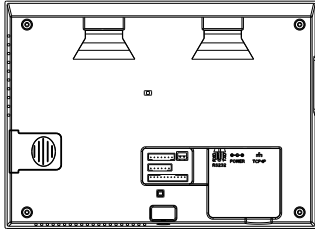

PIN	DESCRIPTION	WIRE
1	Aux	✗ Brown
2	GND	✗ Black
3	SEN	✗ Yellow
4	GND	✗ Black
5	BUT	✗ Blue
6	NO1	✗ White
7	COM1	Purple
8	NC1	Gray
9	NO2	✗ Green
10	COM2	✗ Orange
11	NC2	✗ Brown

✗ Do not use

⚠ Do not reverse the polarity.

FR107 Diode

Normally Closed Lock

Lock Relay Connection

❖ Device sharing power with the lock

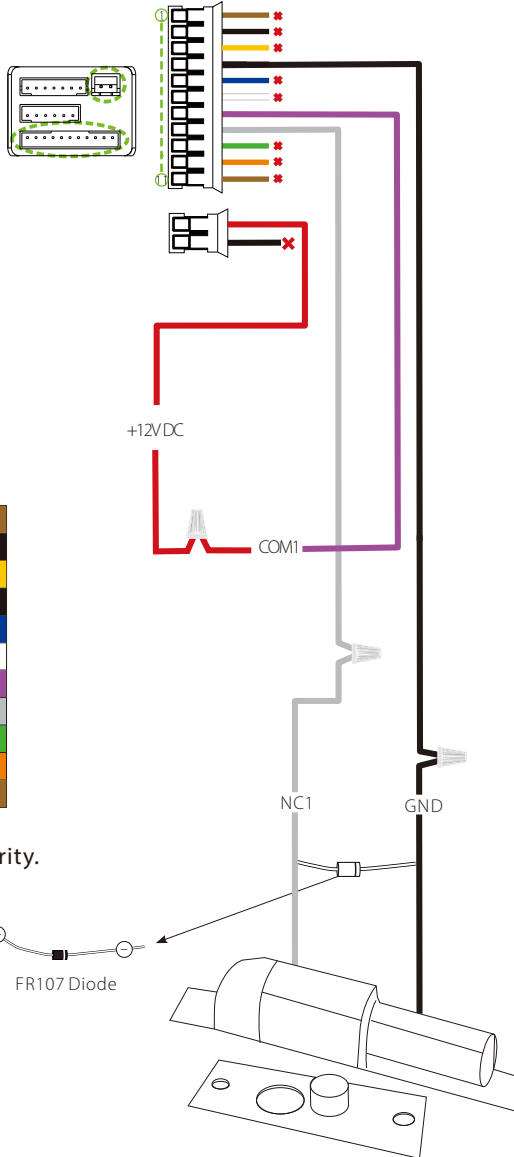
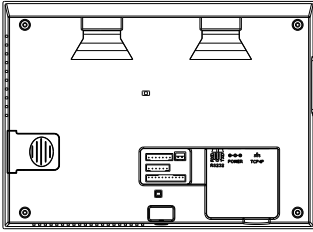

PIN	DESCRIPTION		WIRE
1	Aux	✗	Brown
2	GND	✗	Black
3	SEN	✗	Yellow
4	GND		Black
5	BUT	✗	Blue
6	NO1	✗	White
7	COM1		Purple
8	NC1		Gray
9	NO2	✗	Green
10	COM2	✗	Orange
11	NC2	✗	Brown

✗ Do not use

⚠ Do not reverse the polarity.

FR107 Diode

Normally Closed Lock

⚠ Maximum 12V 2A input.

Button & Sensor Connection

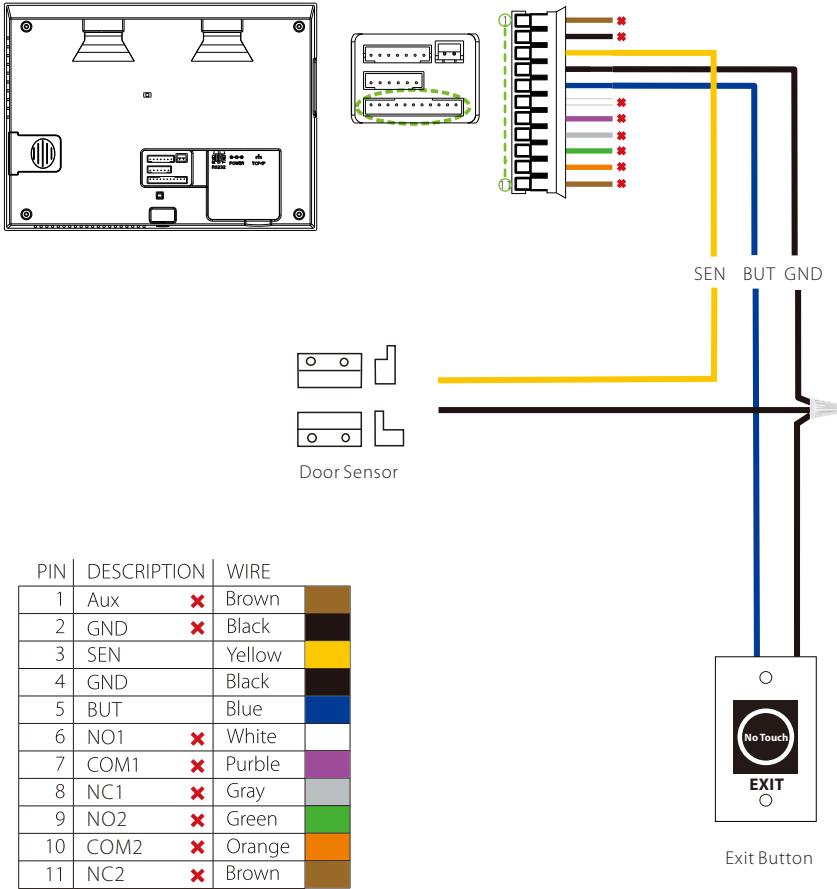

✘ Do not use

 Do not reverse the polarity.

Alarm Connection

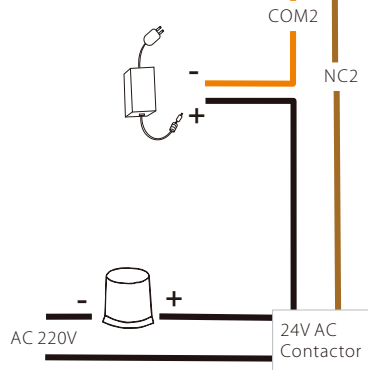
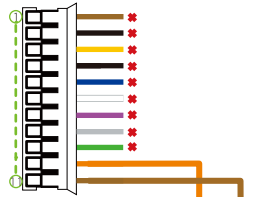
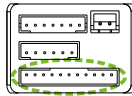
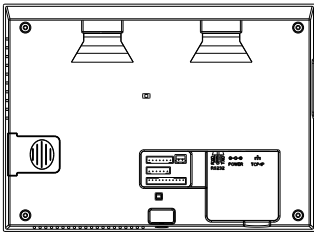
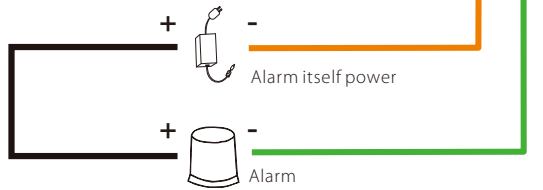
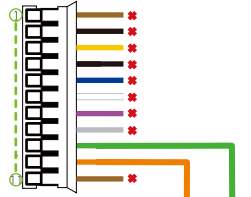
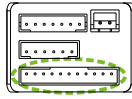
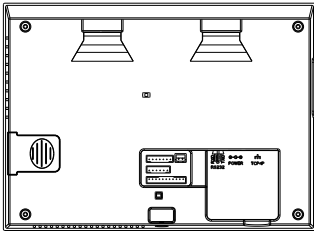

PIN	DESCRIPTION	WIRE
1	Aux	✗ Brown
2	GND	✗ Black
3	SEN	✗ Yellow
4	GND	✗ Black
5	BUT	✗ Blue
6	NO1	✗ White
7	COM1	✗ Purple
8	NC1	✗ Gray
9	NO2	Green
10	COM2	Orange
11	NC2	Brown

✗ Do not use

Wiegand Input & Output Connection

❖ Wiegand In connection

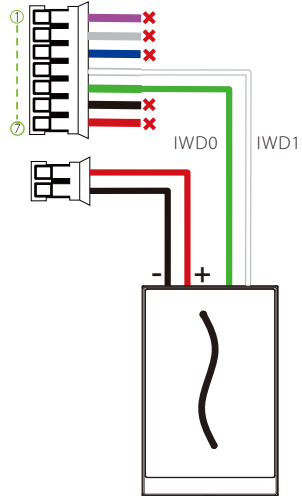
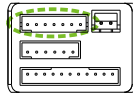
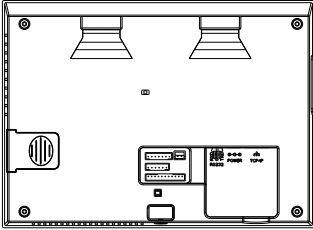

Wiegand reader

PIN	DESCRIPTION	WIRE	
1	BEEP	✗ Purple	
2	GLED	✗ Gray	
3	RLED	✗ Blue	
4	IWD1	White	
5	IWD0	Green	
6	GND	✗ Black	
7	+12V	✗ Red	

✗ Do not use

❖ Wiegand Out connection

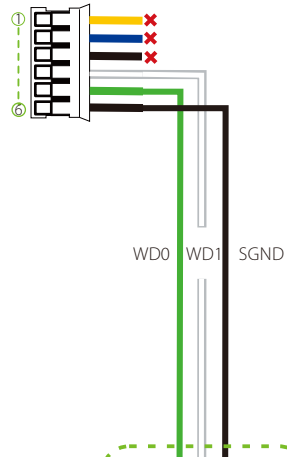
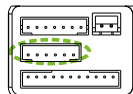
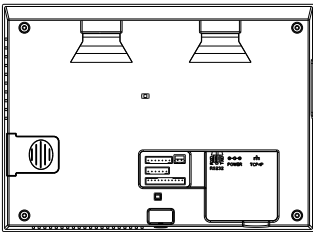

Wiegand Device
Wiegand In Port

PIN	DESCRIPTION	WIRE	
1	485B	✗ Yellow	
2	485A	✗ Blue	
3	GND	✗ Black	
4	WD1	White	
5	WD0	Green	
6	GND	✗ Black	

✗ Do not use

RS485 Connection

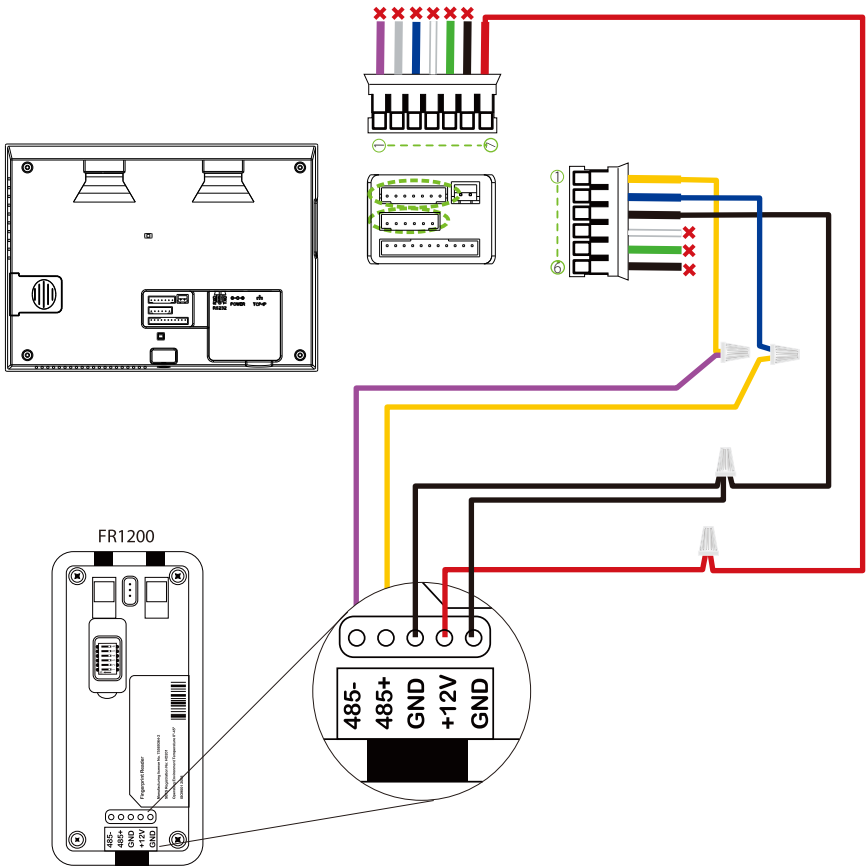

PIN	DESCRIPTION	WIRE	
1	485B	Yellow	
2	485A	Blue	
3	GND	Black	
4	WD1	White	
5	WD0	Green	
6	GND	Black	

✗ Do not use

PIN	DESCRIPTION	WIRE	
1	BEEP	✗ Purple	
2	GLD	✗ Gray	
3	RLED	✗ Blue	
4	IWD1	✗ White	
5	IWD0	✗ Green	
6	GND	✗ Black	
7	+12V	Red	

✗ Do not use

Standalone Installation

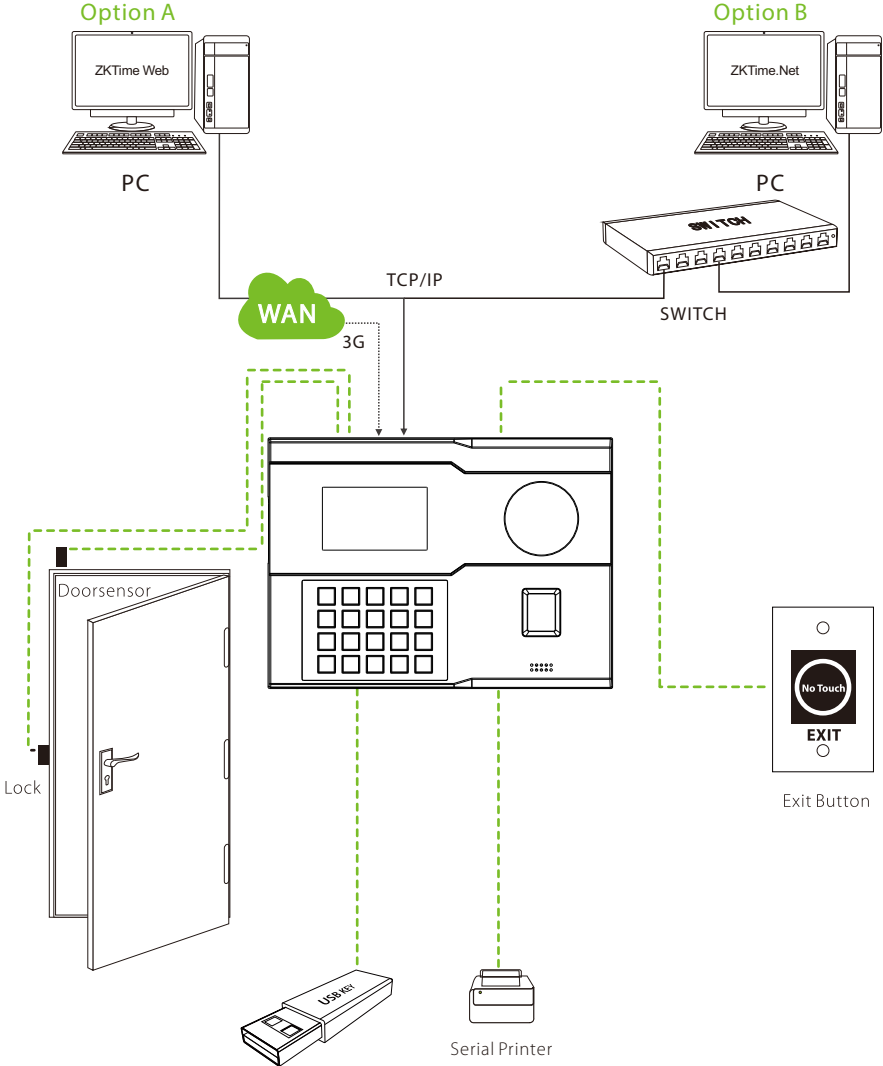

Palm Gestures

❖ Commended positions



Place your palm in the palm multi-mode collection area, such that the palm is placed parallel to the device. Make sure to keep space between your fingers.

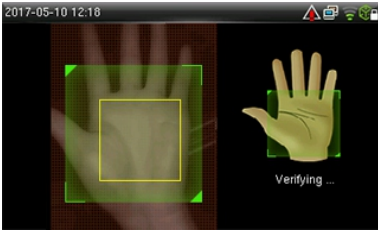

During enrollment locate your palm at the center of the screen, and follow the voice prompts "Center the palm inside the green box". The user needs to move forward and backward to adjust the palm position during the palm registration.

❖ Not commended positions

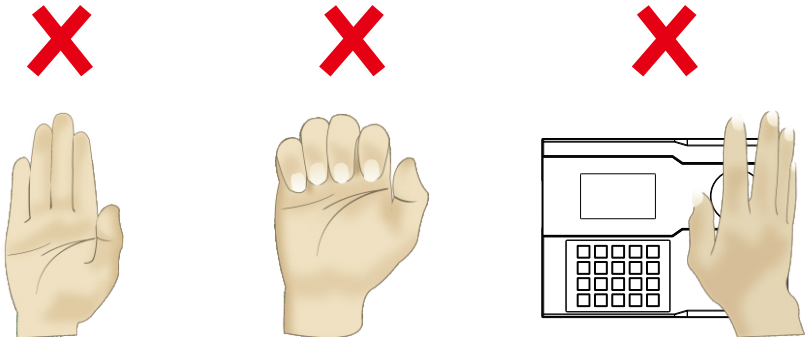

Note: Please keep natural posture while enrolling and verifying.

Device Operation

❖ Quick flows

1) Enroll New Users(Main Menu > User Management > New User)



New User	
User ID	4
Name	
User Role	Normal User
Palm	0
Fingerprint	0
Badge Number	

User ID: Enroll user ID; it supports 1-9 digits of numbers.

Use Role: Select the user role between Normal User and Super Admin.

Verification Mode: Select required mode from list.

Fingerprint ★: Enroll a fingerprint or fingerprints.

Palm: Enroll palm according to the prompts of screen and voice.

Badge Number ★: Enroll a badge by swiping the badge.

Password: Enroll the password; it supports 1-9 digits of numbers.

2) Access Control Setting (Main Menu > Access Control)

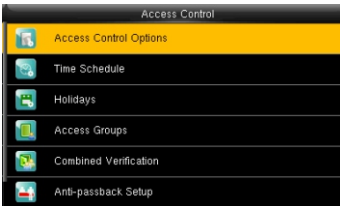

Access Control	
Access Control Options	
Time Schedule	
Holidays	
Access Groups	
Combined Verification	
Anti-passback Setup	

Access Control Options: Including Door Lock Delay, Door Sensor Delay, Door Sensor Type, NC / NO Time Period etc.

3) Comm Setting (Main Menu > Comm.)

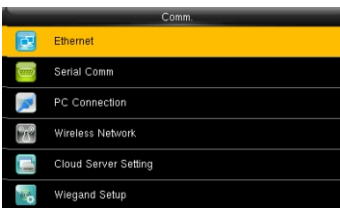

Comm	
Ethernet	
Serial Comm	
PC Connection	
Wireless Network	
Cloud Server Setting	
Wiegand Setup	

Ethernet: The device can communicate with PC via the Ethernet parameters.

Serial Comm: The device can communicate with PC via the serial port according to the user-defined parameters.

PC Connection: Set the password and device ID so that you can connect the device with software in PC.

Cloud Server Setting ★: Settings used for connecting with ADMS server.

Device Operation

4) Verification(1:1 verification mode for example)

a. Palm Verification Mode

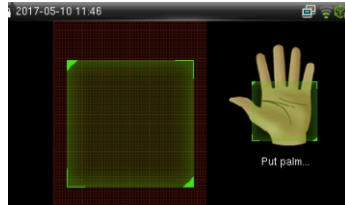

b. Fingerprint Verification Mode



c. Password Verification Mode

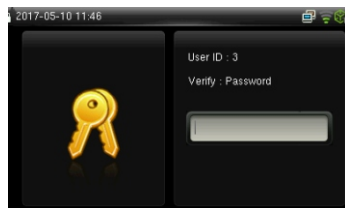

5) Attendance Record

a. View records in the device(Main Menu > Attendance Search > Attendance Record)

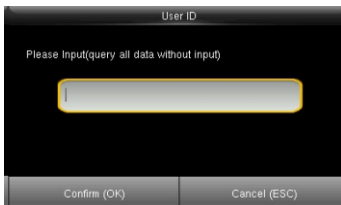

Enter the user ID to search.



Select the time range for attendance record query.

Device Operation

b. View records on computer (Main Menu > USB Manager > Download > Attendance Data)

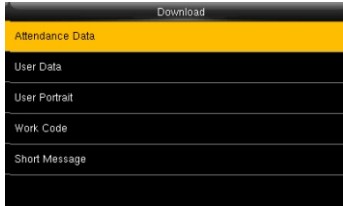

1. Insert the USB disk correctly.
2. Download the attendance data to the disk.
3. Upload the attendance data from the disk to your computer.
4. Name the downloaded data as "Device Serial Number.dat".

You can open the downloaded data and view it.

6) Backup data

To avoid data loss due to mis-operation, you can back up the data to local drive or USB disk at any time.



1. Enter Main Menu > Data Management > Backup Data > Saving Type > Data Type to backup.
2. Select the content to-be-backed up.

7) Some miscellaneous settings

a. Date Time(Main Menu > System > Date Time)

Set the date, time and time format for the device.

b. Work Code(Main Menu > Work Code > New Work Code)

c. Short Message(Main Menu > Short Message)

❖ Troubleshooting

Q: The palm is not recognized by the device while verification.

A: 1.Check out if the palm postures and distance is same in enrolling and verifying.

2.Check out if the sunlight is direct to the device or if the device is near to the windows.

Q: The device make a misjudgment while verification.

A: There is a certain probability of misjudgment, you can re-enroll the palm.

ZK Building, Wuhe Road, Gangtou, Bantian, Buji Town,
Longgang District, Shenzhen China 518129
Tel:+86 755-89602345
Fax:+86 755-89602394
www.zkteco.com

